

Dimension	Tolerance
12 h7	0/ -0.018

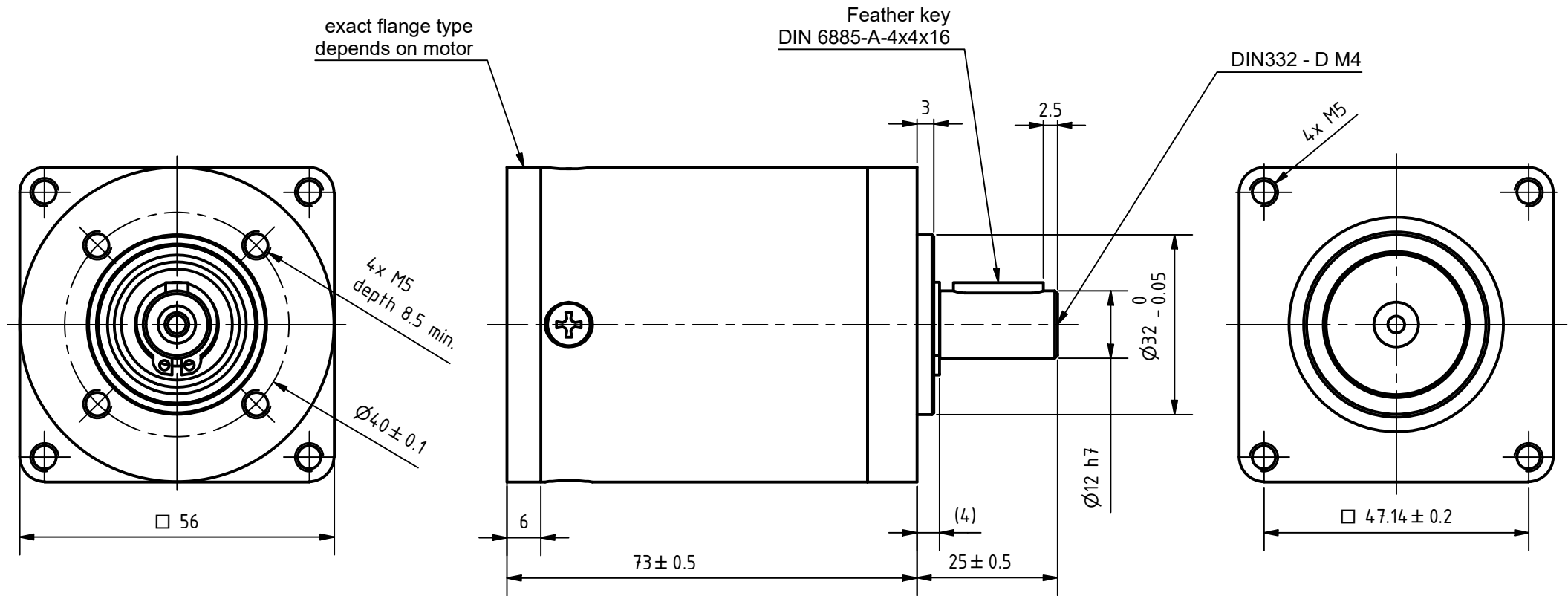

**GEARBOX SPECIFICATION**

Reduction Ratio		20(20.166)
No. of Stages		2
Rated Output Torque	Nm	9.2
Max. Output Torque	Nm	14.8
Rated Input Speed	rpm	3500
Max. Input Speed	rpm	6050
Backlash	°	0.32
Efficiency	%	86
Lifetime	h	5000
Max. Axial Force	N	1360
Max. Radial Force (shaft middle)	N	520
Gearbox Inertia	kg m <sup>2</sup>	3.4 x 10 <sup>-6</sup>
Ambient Temperature	°C	-10 ... 50
Protection Class		IP54

ISO 8015	ISO 1302	ISO 2768 cK	ISO 13715	Weight: ~0.78kg	
			Date	Name	
			Drawn	10.08.2017	Administrator
			Reviewed		
			Released		
00					
REV	Rev. Text	Name	Date		
				20000827	Scale: 1 : 1
				State: Work in Progress	Rev: 00
				CONFIDENTIAL	
				A4	Page 1