

ZK-USB-RS485-1



Technical data sheet Version 1.0.0
 Original: de
 Nanotec Electronic GmbH & Co. KG Phone: +49 (89) 900 686-0
 Kapellenstraße 6 Fax: +49 (89) 900 686-50
 85622 Feldkirchen, Germany info@nanotec.de

Introduction

ZK-USB-RS485-1 is a USB-to-RS485 adapter with galvanic isolation between the USB and RS485 interface. It enables RS485 networks to be connected. Its compact plastic housing also makes it ideal for mobile applications.

Power is supplied via the USB 2.0 type-B plug. The RS485 interface can be connected to a shielded RJ45 socket or a 4-pin PCB terminal. The adapter supports the USB 2.0 Full-Speed interface and is equipped with a half duplex RS485 interface according to TIA/EIA-485.

ZK-USB-RS485-1 also has a line polarization (for Modbus RTU), a switchable bus termination as well as two status LEDs (USB and RS485).

Copyright

© 2020 Nanotec Electronic GmbH & Co. KG. All rights reserved.



Intended use

ZK-USB-RS485-1 is used as a component of drive systems in various industrial applications where a computer needs to be connected to an RS485 network via USB.

Use the product as intended within the limits defined in the technical data (see **Electrical properties and technical data**) and the approved **Environmental conditions**.

Under no circumstances may this Nanotec product be integrated as a safety component in a product or system. All products containing a component manufactured by Nanotec must, upon delivery to the end user, be provided with corresponding warning notices and instructions for safe use and safe operation. All warning notices provided by Nanotec must be passed on directly to the end user.

Warranty and disclaimer

Nanotec assumes no liability for damages and malfunctions resulting from installation errors, failure to observe this manual or improper repairs. The selection and use of Nanotec products is the responsibility of the plant engineer or end user. Nanotec accepts no responsibility for the integration of the product in the end system.

Our general terms and conditions apply: [en.nanotec.com/service/general-terms-and-conditions/](https://www.nanotec.com/service/general-terms-and-conditions/).

Customers of Nanotec Electronic US Inc. please refer to [us.nanotec.com/service/general-terms-and-conditions/](https://www.nanotec.com/service/general-terms-and-conditions/).



Note

Changes or modifications to the product are not permitted.

Target group and qualification

The product and this documentation are directed towards technically trained specialist staff such as software developers, application engineers and installers/service personnel.

Only specialists may install and commission the product. Specialist staff are persons who

- have appropriate training and experience in working with fieldbus systems and electrostatically sensitive components,
- are familiar with and understand the content of this technical manual,
- know the applicable regulations.

EU directives for product safety

The following EU directives were observed:

- RoHS directive (2011/65/EU, 2015/863/EU)
- EMC directive (2014/30/EU)

Technical details and pin assignment

Dimensioned drawings and installation options

All dimensions are in millimeters.

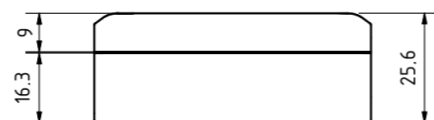
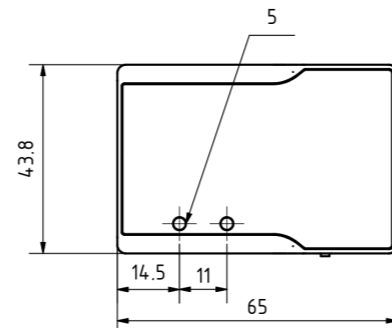

You can secure the adapter using one to three M4 screws. Three M4x6 threaded holes are provided for this purpose:

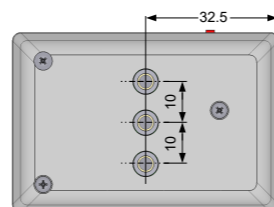

Alternatively, you can also screw on a DIN rail clip and install the adapter in a switch cabinet.

Environmental conditions

Environmental condition	Value	Unit
Ambient temperature (operation)	-10 ... 70	°C
Ambient temperature (storage)	-25 ... 85	°C
Relative air humidity (non-condensing)	0 ... 95	%
Protection class according to EN/IEC 60529	IP 40	

Electrical properties and technical data

Property	Value	Unit	Note
Power supply	5	V DC	via USB
Insulation voltage	2000	V DC	for 1 minute
RS485 baud rate	up to 1000	KBaud	default baud rate 19200 Baud

LED signaling

When USB is initialized, the USB status LED lights up green and the device is ready for operation. If communication is taking place, the LED flashes green. If an error occurs, the LED lights up red.

The RS485 status LED has similar functions. When the RS485 bus is initialized, the LED lights up green. If communication is taking place, the LED flashes green. If an error occurs, the LED lights up red.

LED behavior	USB/RS485 status
continuously red	Error
continuously green	initialized
flashing green	communication taking place

Pin assignment

Overview

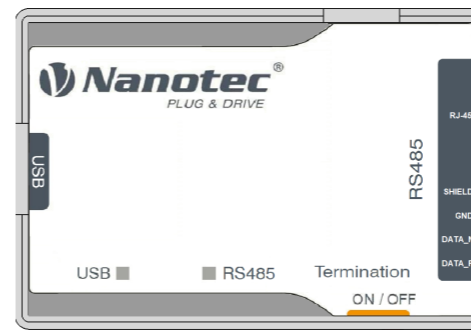

RS485 connection 1 — RJ-45

Type: RJ45 socket

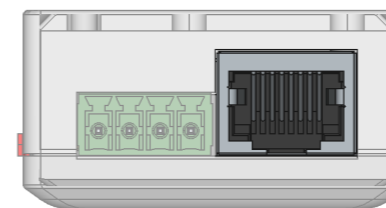

Pin	Function	Note
1	n.c.	
2	n.c.	
3	n.c.	
4	DATA_P	RS485 +
5	DATA_N	RS485 -
6	n.c.	
7	n.c.	
8	GND (Common)	Data Ground
Housing	SHIELD	connected with cable shield

RS485 connection 2 — PCB terminal

- Type: Phoenix Contact MCV 1.5/ 4-G-3.5
- Mating connector (included in scope of delivery): Phoenix Contact FMC 1.5/ 4-ST-3.5 (or equivalent)

Pin 1 is marked with a 1.

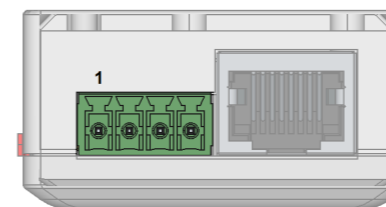

Pin	Function	Note
1	DATA_P	RS485 +
2	DATA_N	RS485 -
3	GND (Common)	Data Ground
4	SHIELD	connection for the cable shield

Termination resistor

Type: Slide switch

This slide switch switches the termination of 150 Ω between RS485+ and RS485- on or off. The "left" switch position switches termination on.

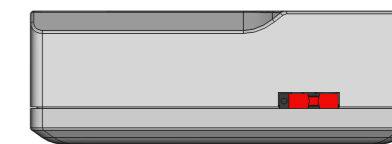

USB connection

Type: USB 2.0, type-B connector. A suitable USB cable is included in scope of delivery.

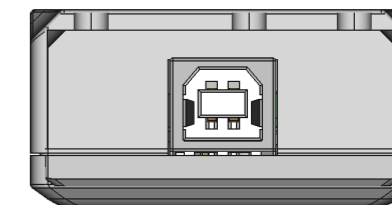

Installing driver and adapter

This chapter explains how to connect the adapter to a PC with Windows 10.

1. Connect the adapter to the PC via USB. The driver is installed automatically and the device bus is detected as a COM port.
2. To find the number of the assigned COM port:
 - a. Click the search icon in the task bar.
 - b. Search for "Device Manager" and select it.
 - c. Go to "Ports (COM & LPT)".

A USB serial device with the assigned COM number (COM "X") appears.