

Technical Manual



Plug & Drive Motors PD2-N

NANOTECH ELECTRONIC GmbH & Co. KG
Kapellenstraße 6
D-85622 Feldkirchen b. Munich, Germany

Tel. +49 (0)89-900 686-0
Fax +49 (0)89-900 686-50
info@nanotec.com

Editorial

© 2013

Nanotec[®] Electronic GmbH & Co. KG

Kapellenstraße 6

D-85622 Feldkirchen b. Munich, Germany

Tel.: +49 (0)89-900 686-0

Fax: +49 (0)89-900 686-50

Internet: www.nanotec.com

All rights reserved!

MS-Windows 2000/XP/Vista are registered trademarks of Microsoft Corporation.

Translation of original handbook

Version/Change overview

| Version | Date | Changes |
|---------|------------|-----------|
| 1.0 | 04.07.2012 | New issue |
| 1.1 | 25.06.2013 | Update |

About this manual

Target group

This technical manual is aimed at designers and developers who need to operate a Nanotec[®] stepper motor without much experience in stepper motor technology.

Important information

This technical manual must be carefully read before installation and commissioning of the Plug & Drive motor.





Nanotec[®] reserves the right to make technical alterations and further develop hardware and software in the interests of its customers to improve the function of this product without prior notice.

This manual was created with due care. It is exclusively intended as a technical description of the product and as commissioning instructions. The warranty is exclusively for repair or replacement of defective equipment, according to our general terms and conditions; liability for subsequent damage or errors is excluded. Applicable standards and regulations must be complied with during installation of the device.

For criticisms, proposals and suggestions for improvement, please contact the above address or send an email to: info@nanotec.de

Additional manuals

Please also note the following manuals from Nanotec:

| | | |
|----------------------------------|---|---|
| NanoPro User Manual | Configuration of controllers with the NanoPro software |  |
| NanoCAN User Manual | Configuration of the CAN communication for CANopen-capable controllers with the NanoCAN software |  |
| Nanotec CANopen reference | Comprehensive documentation of the CANopen functions |  |
| Programming manual | Control programming <ul style="list-style-type: none"> • Command reference • NanoJ • COM interface |  |

The manuals are available for download at www.nanotec.com.

Contents

| | |
|--|-----------|
| Editorial..... | 2 |
| About this manual..... | 3 |
| Contents | 5 |
| 1 Overview | 7 |
| 2 Connection and commissioning | 10 |
| 2.1 Overview | 10 |
| 2.2 Connection diagram | 11 |
| 2.3 Commissioning..... | 12 |
| 3 Connections and circuits | 16 |
| 3.1 Inputs and outputs (JST-ZPD-12)..... | 16 |
| 3.2 Voltage supply and RS485 network/ CANopen (JST-ZPD-10) | 18 |
| 4 Operating modes..... | 23 |
| 4.1 Serial operating modes | 23 |
| 4.2 CANopen operating modes..... | 24 |
| 5 Troubleshooting..... | 26 |
| 6 Technical data | 28 |
| Index..... | 33 |

1 Overview

Introduction

The PD2-N Plug & Drive motor includes, in addition to the integrated power end stage, a complete, network-capable closed loop speed and positioning control.

The PD2-N not only significantly reduces development and installation outlay, but also space and component requirements. It also increases flexibility, system properties and the availability of a complete drive unit. Replacement of existing drive solutions is easy with the mechanical and electrical compatibility with standard motors.

Variants

The PD2-N is available in the following variants that differ in firmware:

- PD2-N4118L1804-2
- PD2-N4118L1804-3

Firmware variants

The Plug & Drive motor can be operated with the following firmware variants:

- RS485 firmware
- CANopen firmware

Functions of the PD2-N

The PD2-N Plug & Drive motor has the following functions:

- Microstep 1/1 – 1/64 Final output stage (0.014° step resolution)
- Closed loop current control (sinusoidal commutation via the encoder)
- Powerful DSP microprocessor for flexible I/O
- Sequence programs with NanoJ (RS485)
- Integrated encoder for rotation monitoring and closed loop current control
- RS485/CANopen interface for parameterization and control (USB connection possible via converter cable ZK-RS485-USB)
- Network capability with up to 254 motors (RS485) or 127 motors (CANopen)
- Easy programming with Windows software NanoPro (RS485) or NanoCAN (CANopen)

ClosedLoop

Closed loop current control (sinusoidal commutation via the encoder):

In contrast to conventional stepper motor controllers where only the motor is actuated or the position adjusted via the encoder, sinusoidal commutation controls the stator magnetic field via the rotary encoder as in a servo motor. The stepper motor acts in this operating mode as nothing more than a high pole servomotor, i.e. the classic stepper motor noises and resonances vanish. As the current is controlled, the motor can no longer lose any steps up to its maximum torque.

If the controller recognizes that the rotor is falling behind the stator field due to overload, adjustments are made with optimal field angle and increased current. In the opposite case, i.e. if the rotor is running forward due to the torque, the current is automatically reduced so that current consumption and heat development in the motor and controller are much lower compared to normal controlled operation.

dspDrive[®]

With dspDrive[®], the motor current is controlled directly by a digital signal processor. Unlike conventional ICs, which resolve the winding current measurement and the target current value with only 6 or 8 bit, the new dspDrive[®] performs the entire control with a resolution of 12 bit. The parameters of the PI current controller can be adjusted to the motor and by the user as a function of the rpm.

This has the following application advantages:

- Very smooth, low-resonance operation with a sinusoidal current in the windings, even at low speeds.
- Very good step angle precision and synchronization, even in open loop operation.

NanoJ

The integrated programming language NanoJ, based on the Java standard, means complete application programs can be realized on the drivers that can be executed independently without a higher-order controller.

The programs can be created, compiled directly and written to the controller with the free NanoJEasy editor.

NanoJ is only supported by the RS485 firmware.

More detailed information can be found in the separate programming manual.

Activation via CANopen



It is possible to include the stepper motor controller in a CANopen environment with the PD2-N. The connection can be established either via 2 wires of the I/O connection cable or in a customer-specific version also via an M12 connector (5-pole).

More detailed information on this can be found in the CANopen reference and in the NanoCAN user manual.

In addition, the Plug & Drive motor via CANopen has another safety function: Even when the voltage supply of the PD2-N is interrupted, the processor continues to be supplied with power via the communication line and the position data cannot be lost so that the machine does not need to be referenced after being switched on.

Settings

The operating behavior of the motor can be set and optimized according to individual requirements by setting the motor-related parameters. The parameters can be set using the NanoPro or NanoCAN software and significantly reduce commissioning time.

More detailed information on this can be found in the separate NanoPro or NanoCAN user manual.

Rotation monitoring

Even if stepper motors do not lose steps during normal operation, the integrated speed control provides additional security in all operating modes, e.g. against motor stalling or other external sources of error. The monitoring function detects a stalled motor or step loss after tenth of a step at the most (for 1.8° stepper motors with 500 pulses/rotation).

Automatic error correction is possible after the drive profile is ended or during the drive.

2 Connection and commissioning

2.1 Overview

Plug connections

The PD2-N Plug & Drive motor is equipped with the following plug connections:

- JST-ZPD-12: inputs and outputs
- JST-ZPD-10: voltage supply, RS485/CANopen

Configuration

The following figure shows the configuration of the connectors:

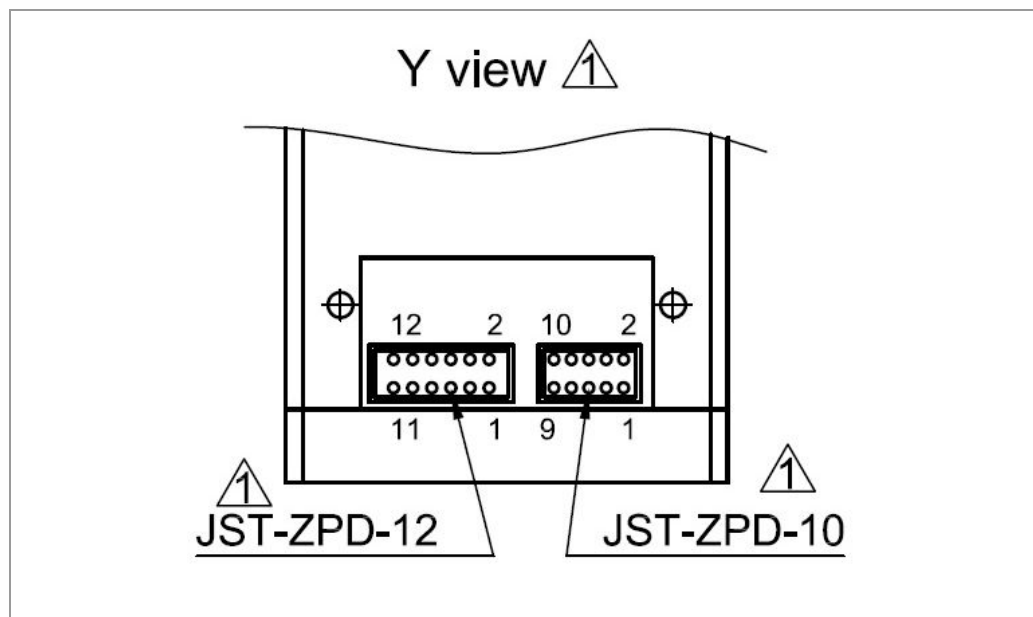

Connection cable

For making the connection, you need the PD2-N cable set (order number: ZK-PD2N-2 for RS485 and ZK-PD2N-3 for CANopen).

2.2 Connection diagram

To operate the Plug & Drive Motor, you must implement the wiring according to the following connection diagram.

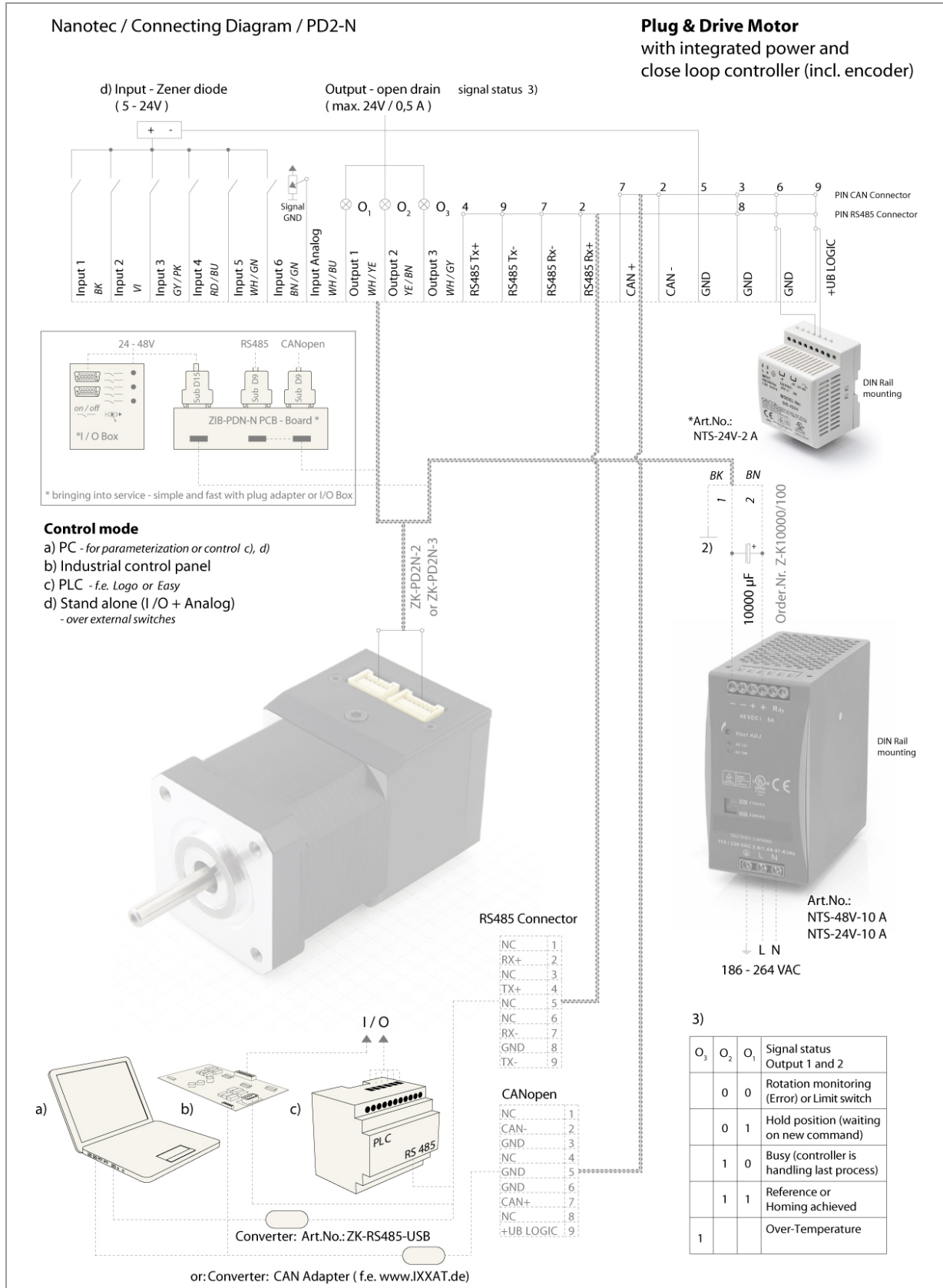

2.3 Commissioning

Introduction

The connection and commissioning of the PD2-N Plug & Drive motor are described below.

This section describes the main first steps you need to take to be able to quickly begin working with the PD2-N if you want to work with the NanoPro (RS485) or NanoCAN (CANopen) software from a PC. You will find more detailed information in the separate NanoPro and NanoCAN manuals.

If you want to work at a later time with a PLC or your own program, you will find the necessary information in the separate "Command Reference".

Familiarize yourself with the PD2-N Plug & Drive motor and the relevant NanoPro or NanoCAN control software before configuring the Plug & Drive motor for your application.

Selecting the firmware

Proceed as follows to commission the Plug & Drive motor with the RS485 firmware.

| Step | Action | Note |
|------|---|--|
| 1 | Install the NanoPro control software on your PC. See the NanoPro separate manual. | Download from www.nanotec.com |
| 2 | Connect the PC to the RS485 interface of the Plug & Drive motor according to the connection diagram. | Connection diagram, see Section 2.2. |
| 3 | Open the following menu in NanoPro: <System / Change firmware / Select firmware>. A window opens in which the firmware can be selected. | |
| 4 | Select the desired firmware (e.g. „firmware_enc_PD2-N_rs485_01-03-2012-rev4652.hex“) and click on "Open". | |

Commissioning with NanoPro (RS485 firmware)

Proceed as follows to commission the Plug & Drive motor with the RS485 firmware:

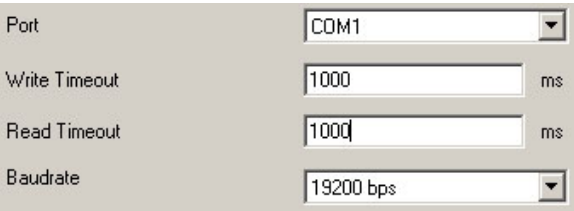
| Step | Action | Note |
|------|---|---|
| 1 | Install the NanoPro control software on your PC. See the NanoPro separate manual. | Download of www.nanotec.com |
| 2 | Connect the Plug & Drive motor according to the connection diagram. | Connection diagram, see Section 2.2. Detailed information on connections can be found in Section 3. |
| 3 | Switch on the operating voltage (12 V DC ... 48 V DC). CAUTION! An operating voltage > 50 V will destroy the output stage! • Follow the information in Section 3.2. | |
| 4 | If necessary, install the driver for the converter cable ZK-RS485-USB. | Download from www.nanotec.com in the "Accessories/Converter" menu item |
| 5 | Connect the Plug & Drive motor with the USB port of your PC. Use the converter cable ZK-RS485-USB. Connection via the RS232 interface is not possible. | Order number: • ZK-RS485-USB |
| 6 | Start the NanoPro software. | The NanoPro main menu appears. |
| 7 | Select the <Communication> tab.  | |
| 8 | In the "Port" field, select the COM port to which the PD2-N is connected.  | The number of the COM port to which the Plug & Drive motor is connected can be found in the device manager of your Windows PC (System Supervision/System/Hardware). |
| 9 | Select the "115200 bps" entry in the "Baudrate" selection field. | |

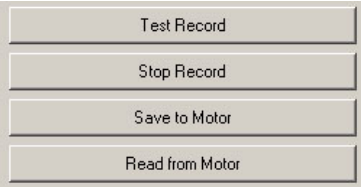
| Step | Action | Note |
|------|---|---|
| 10 | <p>Check the current setting using the motor data sheet on the <Motor Settings> tab.</p> <p>Presettings:</p> <ul style="list-style-type: none"> • Phase current: 50% (current level) • Phase current during idle: 25% (idle current) | Under no circumstances may the current be set to a value higher than the rated current of the motor. |
| 11 | <p>Select the "Movement Mode" tab.</p>  | |
| 12 | <p>Click on the <Test Record> button to carry out the pre-set travel profile.</p>  | The connected motor operates with the pre-set travel profile (default travel profile after new installation). |
| 13 | <p>You can now enter your required settings. For instance, you can enter a new travel profile.</p> | See the NanoPro separate manual. |

Commissioning with NanoCAN (CANopen firmware)

Proceed as follows to commission the Plug & Drive motor with the CANopen firmware. More detailed information can be found in the separate NanoCAN manual.

| Step | Action | Note |
|------|---|--|
| 1 | Install the NanoCAN control software on your PC. | Download from www.nanotec.com |
| 2 | Connect the Plug & Drive motor to the stepper motor according to the connection diagram. | Connection diagram, see Section 2.2. Detailed information on connections can be found in Section 3. |
| 3 | Switch on the operating voltage (12 V DC ... 48 V DC). CAUTION! An operating voltage > 50 V will destroy the output stage! <ul style="list-style-type: none"> Follow the information in Section 3.2. | |
| 4 | Install and configure your CANopen adapter. | Details can be obtained from the manufacturer of the CANopen adapter. |
| 5 | Start the NanoCAN software. | |
| 6 | Select the desired node ID, the baud rate and, if necessary, the CAN card in the <Configuration & NMT> tab. | |
| 7 | Check the current setting using the motor data sheet. Presettings: <ul style="list-style-type: none"> Phase current: 50% (current level) Phase current during idle: 25% (idle current) | Under no circumstances may the current be set to a value higher than the rated current of the motor. |
| 8 | Select the desired operating mode (e.g. PP mode) in the <Drive Modes> tab. | |
| 9 | Click on the <Power on> button. | |
| 10 | Enter the desired target position in the "target" field. | |
| 11 | Click on the <Start> button. | |

3 Connections and circuits

3.1 Inputs and outputs (JST-ZPD-12)

Introduction

An overview of the assignments can be found in the connection diagram in Section 2.2. This section looks in detail at the assignment, functions and circuits of the connections.

Pin assignment

| Pin no. | Name | Wire color ZK-PD2N-2 or ZK-PD2N-3 |
|---------|--------------|--------------------------------------|
| 1 | GND | GY/BN |
| 2 | Input 1 | BK |
| 3 | Input 2 | VI |
| 4 | Input 3 | GY/PK |
| 5 | Input 4 | RD/BU |
| 6 | Input 5 | WH/GN |
| 7 | Input 6 | BN/GN |
| 8 | Analog Input | WH/BU |
| 9 | Output 1 | WH/YE |
| 10 | Output 2 | YE/BN |
| 11 | Output 3 | WH/GY |
| 12 | GND | RD |

Input circuits

All inputs (apart from the "Analog In" input) are wired through a Zener diode and designed for 5-24 V input signals at an input current of 8 mA.

Note:

The voltage must not exceed 24 V. It should drop below 2.5 V for safe switching off and be at least 3 V for safe switching on.

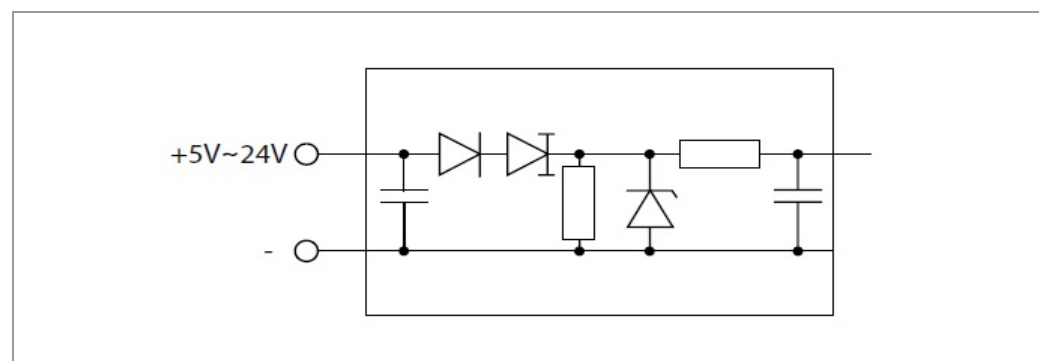

Function of the inputs

All digital inputs – with the exception of the "Clock" input in the clock directional mode – can be freely programmed using the NanoPro software (RS485) (e.g. as a limit position switch, enable, etc.) and can be used for sequential control with NanoJ.

All inputs can be configured for "active-high" (PNP) or "active-low" (NPN) with NanoPro.

Output wiring

The outputs are MosFET outputs in an Open-Drain circuit (0 switching, max. 24 V/0.5 A). An LED can be integrated to test the output. The LED lights up when the output is active.

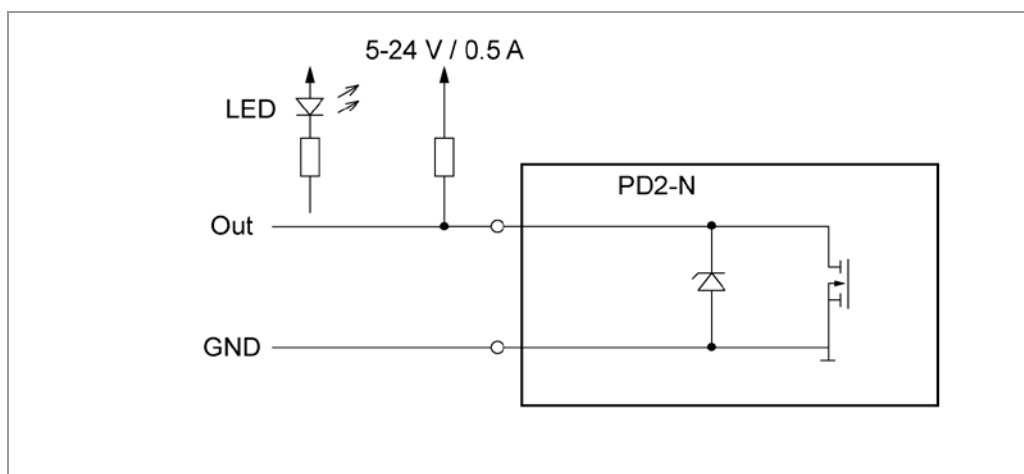

Signal states at the outputs (RS485)

Note:

In the CANopen firmware, the status of the controller is not displayed at the outputs.

The following table shows the possible signal states at the outputs 1 to 3:

| Signal states | | | Meaning |
|---------------|----------|----------|---|
| Output 3 | Output 2 | Output 1 | |
| | 0 | 0 | Rotation monitoring (error) or limit switch |
| | 0 | 1 | Motor idle (waiting for new command) |
| | 1 | 0 | Busy (control processing last command) |
| | 1 | 1 | Reference point or zero point reached |
| 1 | | | Overtemperature |

The outputs can be freely programmed using the NanoPro software.

Note:

Output 3 is also used to display errors and when switching on the controller.

3.2 Voltage supply and RS485 network/ CANopen (JST-ZPD-10)

Permissible operating voltage

The permissible operating voltage of the Plug & Drive motor PD2-N lies within the range +12 to +48 V DC and must not exceed 50 V or undershoot 11 V.

A charging condenser with minimum 4700 μF (10000 μF) must be provided for the operating voltage to prevent exceeding the permissible operating voltage (e.g. during braking).



Danger of electrical surges

Connect charging condenser with minimum 4700 μF !

An operating voltage > 50 V will destroy the output stage!

Mixing up the connections can destroy the output stage!

Never disconnect the motor when operating voltage is applied!

Never disconnect lines when live!

Accessories for voltage supply

Appropriate power packs and charging condensers are available as accessories:

| Name | Order identifier |
|--------------------|---|
| Power pack | NTS-xxV-yA (xx=voltage: 12, 24 or 48 V, y=current: 2.5, 5 or 10 A) Information on the selection of the required power supply unit can be found in our FAQ on www.nanotec.com . |
| Charging condenser | Z-K4700 or Z-K10000 |

Note:

Further information about accessories can be found on the Nanotec website: www.nanotec.com.

PD2-N in a network

Generally, up to 254 (RS485) or 127 (CANopen) Plug & Drive motors can be actuated in a network from a PC or PLC.

These network connections are set up via the RS485/CANopen interface.

ZK-PD2N -2 pin assignment for RS485 interface

| Pin no. | Name | ZK-PD2N-2 |
|---------|-----------|-----------------------|
| 1 | GND | |
| 2 | GND | |
| 3 | RS485 Rx- | |
| 4 | RS485 Rx+ | |
| 5 | RS485 Tx- | |
| 6 | RS485 Tx+ | |
| 7 | GND | Black |
| 8 | Vcc | Brown, voltage supply |
| 9 | Vcc | Brown, voltage supply |

| Pin no. | Name | ZK-PD2N-2 |
|---------|------|-----------|
| 10 | GND | Black |

ZK-PD2N-3 pin assignment for CANopen interface

| Pin no. | Name | ZK-PD2N-3 |
|---------|-----------|-----------------------|
| 1 | GND | |
| 2 | GND | |
| 3 | +UB LOGIC | |
| 4 | NC | |
| 5 | CAN- | |
| 6 | CAN+ | |
| 7 | GND | Black |
| 8 | Vcc | Brown, voltage supply |
| 9 | Vcc | Brown, voltage supply |
| 10 | GND | Black |

CANopen

With the PD2-N it is also possible to control the motor via CANopen.

If you use the Plug & Drive motor with CANopen, you can use the additional safety function of the separate logic supply: Even when the voltage supply of the PD2-N is interrupted, the processor continues to be supplied with power via the communication line and the position data cannot be lost so that the machine does not need to be referenced after being switched on.

More detailed information on this can be found in the CANopen reference and in the NanoCAN user manual.

CANopen connection

A suitable CAN interface adapter (e.g. USB adapter from IXXAT or PEAK) is required for connecting with a PC.

CANopen standard connector assignment (on the adapter)

| Pin no. | Name |
|---------|----------|
| 2 | CAN low |
| 3 | CAN GND |
| 7 | CAN high |

CANopen connection assignments on the controller

Circuitry according to the "Pin assignment" table (see above on this page)

Notes on the baud rate

It is important to note that both the controller and the CAN master use the same baud rate. Only this way can communication be established.

The baud rate has a direct influence on the maximum possible bus length. The following setting shows the possible baud rates and the associated maximum permissible bus lengths.

| Baud rate | Bus length |
|-----------|------------|
| 1 MBaud | 40 m |
| 500 kBaud | 130 m |
| 250 kBaud | 270 m |
| 125 kBaud | 530 m |
| 50 kBaud | 1300 m |
| 20 kBaud | 3300 m |

Notes on the bus termination

With CAN, the bus termination is handled by two 120 Ohm resistors on both ends of the bus.

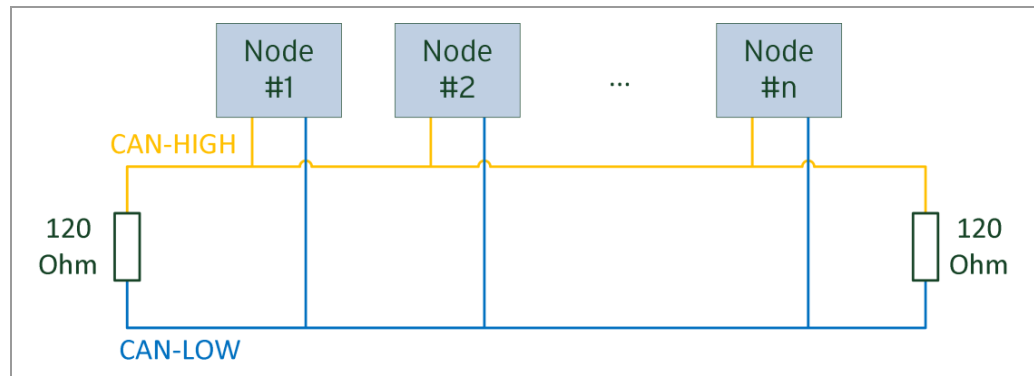

Two-wire operation RS485

To enable RS485 two-wire transmission capability, all bus stations must have a direction control.

An intelligent converter, which automatically switches to transmission mode when a start bit is received at the RS232 interface and returns to reception mode at the end of the stop bit, enables two-wire operation of the PD2-N. This solution requires no software support.

We can recommend the ICP-7520 converter, for example, that is available from Schuricht.

Talk to our Technical Hotline if you require support for this.

Setting the RS485/CANopen module address

A maximum of 127 addresses can be set though they can only be used to their full extent via CANopen.

The RS485 module address can be set to a maximum of 254 addresses in the software and read out from EEPROM.

4 Operating modes

4.1 Serial operating modes

Introduction

Depending on the travel profile, the motor can be operated using different operating modes. Due to the great capacity and functions available, it offers designers and developers a rapid and simple method of resolving numerous drive requirements with less programming effort.

Select the required operating mode for each drive profile and configure the controller according to your requirements.

More detailed information can be found in the separate NanoPro manual.

Overview of operating modes and their areas of application

| Operation mode | Application |
|------------------------|---|
| Relative positioning | Use this mode when you wish to travel to a specific position. The motor travels according to a specified drive profile from a Position A to a Position B. |
| Absolute positioning | |
| Internal reference run | During the internal reference run, the motor travels to an internal reference point at the set minimum speed (index mark of encoder, only in combination with an encoder). |
| External reference run | During an external reference run, the motor travels to a switch connected to the reference input. |
| Speed mode | Use this mode when you wish to travel with a specific speed (e.g. a conveyor belt or pump speed). In the speed mode, the motor accelerates with a specified ramp from the starting speed (start frequency "V Start") to the specified maximum speed (maximum frequency "V Normal"). Several inputs enable the speed to be changed on-the-fly to different speeds. |
| Flag positioning mode | The flag positioning mode offers a combination of the speed and positioning modes. The motor is initially operated in speed mode; when a trigger point is reached, it changes to the positioning mode and the specified setpoint position (relative to the trigger position) is approached. This operating mode is used for labeling, for example: the motor first travels with the set ramp to the synchronous speed of the conveyed goods. When the labels are detected, the preset distance (position) is traveled to apply the labels. |

| Operation mode | Application |
|--------------------------------|---|
| Clock direction mode, left | <p>Use this mode when you wish to operate the motor with a superordinate controller (e.g. CNC controller). In the clock direction mode, the motor is operated via two inputs with a clock and a direction signal from a superordinate positioning control (indexer).</p> <p>Depending on the mode selected (Int. Ref./Ext. Ref.), the internal and external reference runs are supported. The maximum possible clock frequency is 130 kHz for the PD2-N because of the input circuit.</p> |
| Clock direction mode, right | |
| Clock direction mode Int. Ref. | |
| Clock direction mode Ext. Ref. | |
| Analog and joystick mode | <p>The motor is controlled in this operating mode simply with a potentiometer or a joystick (−10 V to +10 V). Use this mode if you want to use the motor in a simple application:</p> <ul style="list-style-type: none"> • Setting a specific speed, e.g. via an external potentiometer, • Traveling synchronously with a superordinate controller with analog output (−10 V to +10 V). |
| Analogue positioning mode | <p>Use this mode when you wish to travel to a specific position. The voltage level on the analog input is proportional to the required position.</p> |
| Torque mode | <p>Use this mode when you require a specific output torque independent of the speed as is the case in typical winding and unwinding applications. The maximum torque is specified via the analog input.</p> |

Selecting the operating mode in NanoPro

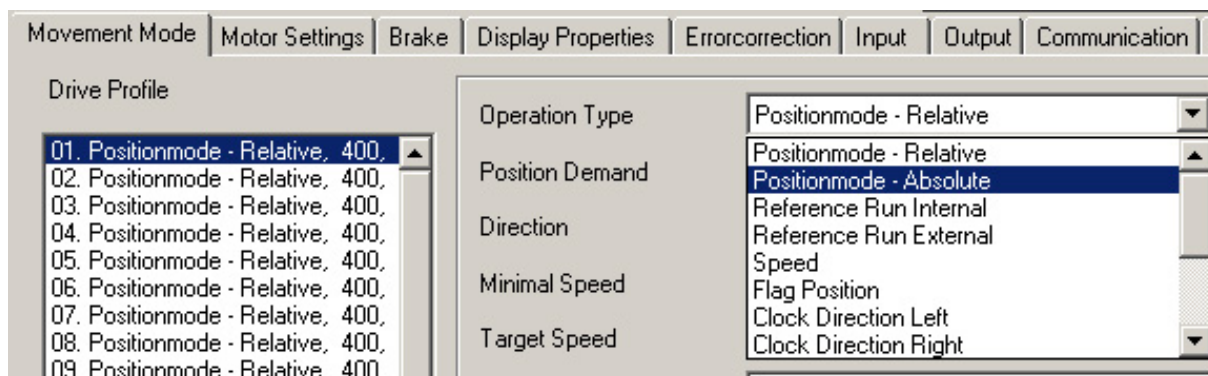

4.2 CANopen operating modes

Introduction

The motor can be operated using a total of 5 different operating modes in CANopen mode.

More detailed information can be found in the separate NanoCAN manual.

Overview of operating modes and their areas of application

| Operation mode | Application |
|---------------------------------------|---|
| Positioning Mode (PP Mode) | Use this mode if you want to use the motor for positioning. The motor moves from A to B with the set parameters (ramp, speed, etc.). |
| Speed Mode (Velocity Mode) | Use this mode when you wish to travel with a specific speed (e.g. a conveyor belt). |
| Reference run (Ref. Mode/Homing Mode) | Use this mode to reference the motor (internal/external/on block). |
| Interpolated Position Mode | Use this mode with a superordinate path control. |
| Torque Mode | Use this mode to specify a defined torque. |

Selecting the operating mode in NanoCAN

In the <Drive Modes> tab the operating mode can be selected. When the tab is activated, the corresponding SDO is immediately written to the controller to activate the (possibly previously) selected operating mode.

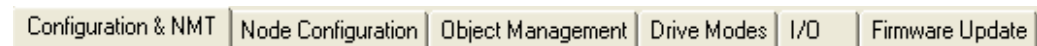

5 Troubleshooting

Troubleshooting procedure

Proceed with care during troubleshooting and error rectification to avoid damaging the Plug & Drive Motor.

| | |
|---|--|
|  | <p>Danger of electrical surges</p> <p>An operating voltage > 50 V and incorrect connections can destroy the end stage. Never disconnect the motor when operating voltage is applied! Never disconnect lines when live!</p> |
|---|--|

Possible errors in serial mode

| Error | Possible cause | Rectification |
|---------------------------------|---|---|
| Plug & Drive Motor is not ready | Data transfer to PD2-N is not possible (communication error): Incorrect COM port selected. | On the <Communication> tab, select the PC port on the PC to which you have connected the PD2-N (e.g. "COM-1"). The port used can be found in the device manager of your PC. |
| | Communication cable not connected or interrupted (incorrect RS485 converter used). | Use the recommended RS485 converter from Nanotec: <ul style="list-style-type: none"> • Order identifier: ZK-RS485-USB |
| | A non-existent motor number (module number) is set. | Set the correct module address. See the separate manual on NanoPro. |
| | The voltage supply to the PD2-N is interrupted. | Check voltage supply, switch on if necessary. |
| | Another open program is blocking the COM port to which the PD2-N is connected. | Close down other programs on your PC. |
| | Inadmissible data was sent to the Plug & Drive motor during the output of a travel profile. | Click on the <Yes> button to stop the travel profile. The PD2-N switches to the "Ready" status. The data can then be resent to the Plug & Drive Motor. |
| Transmission error | The data transfer to the PD2-N is disturbed (transmitter or receiver is disturbed). | Check that the motor connection is correctly wired. We recommend using the following Nanotec converters/cables: <ul style="list-style-type: none"> • ZK-PD2N-2 (for RS485) • ZK-PD2N-3 (for CANopen) • ZK-RS485-USB |
| Position error | The motor cannot reach the position or the limit switch was overrun. | Click the <Yes> button in the error message; the error is reset. |

Possible errors in CANopen mode

| Error | Possible cause | Rectification |
|--------------------------------------|---|---|
| No communication with the controller | The wrong node ID has been set. | On the <Configuration & NMT> tab in NanoCAN, select the node ID that is set on the rotary switches of the controller. |
| | The power supply is interrupted. | Check voltage supply, switch on if necessary. |
| | The communication cable is not connected or is interrupted. | Check all connections, especially the terminal resistances. |
| | CAN bus incorrectly terminated with 120 Ohm. | Ideally, terminate the bus on both ends with 120 Ohm. |
| Transmission error | Data transmission is disturbed (sporadically). | Switch the power supply off and on again. |

6 Technical data

Electrical connections

| | |
|-------------------------|--|
| Operating voltage V_b | DC 12 V to 48 V $\pm 4\%$ Lower voltage limit: 11 V (undervoltage switch-off) Upper voltage limit: 50 V (overvoltage switch-off) |
| Max. phase current | Adjustable up to max. 2.7 A/phase Continuous current 1.8 A/phase |
| Current drop | Adjustable 0 to 150% of rated current |
| Interfaces | RS485 (4-wire) <ul style="list-style-type: none"> • 115200 bps (adjustable) • 1 start bit, 8 data bits, 1 stop bit • No parity CAN bus (CANopen) <ul style="list-style-type: none"> • 1 MBaud (adjustable) |

Motor parameters

| | |
|---------------------|---|
| Step resolution | Full Step Half Step Quarter Step Fifth Step Eighth Step Tenth Step 16th step 32nd step 64th step Feed rate Adaptive microstep (1/128) |
| Step angle | 1.8° |
| Operating modes | Position Speed Flag position Clock direction Analog Analogue positioning mode Joystick Torque |
| Step frequency | 0 to 50 kHz in clock direction mode 0 to 25 kHz in all other modes |
| Position monitoring | Automatic error correction up to 0.9° (depending on encoder resolution) |

Inputs and outputs

| | |
|---------|---|
| Inputs | 6 channels, 5 – 24 V <ul style="list-style-type: none"> • Safe switch off: max. 2,5 V • Safe switch on: min. 3 V |
| Outputs | 3 MosFET outputs <ul style="list-style-type: none"> • Open-Drain (0 switching, max. 24 V/0.5 A) • Signal delay time: output 1/2: H12 μs (with 10 kΩ-Pull-Up at 24 V) |

Protective circuits

| | |
|------------------------------|--|
| Overvoltage and undervoltage | Protective circuit for voltages > 50 V or < 11 V |
| Max. heat sink temperature | Approx. 67 °C |
| Ambient temperature | -10 °C to 40 °C |

Holding torque, weight and dimensions

PD2-N4118

| Variants | Holding torque (Ncm) | Weight (kg) | Length (mm) |
|----------------|----------------------|-------------|-------------|
| PD2-N4118L1804 | 50 | 0,39 | 75,4 |

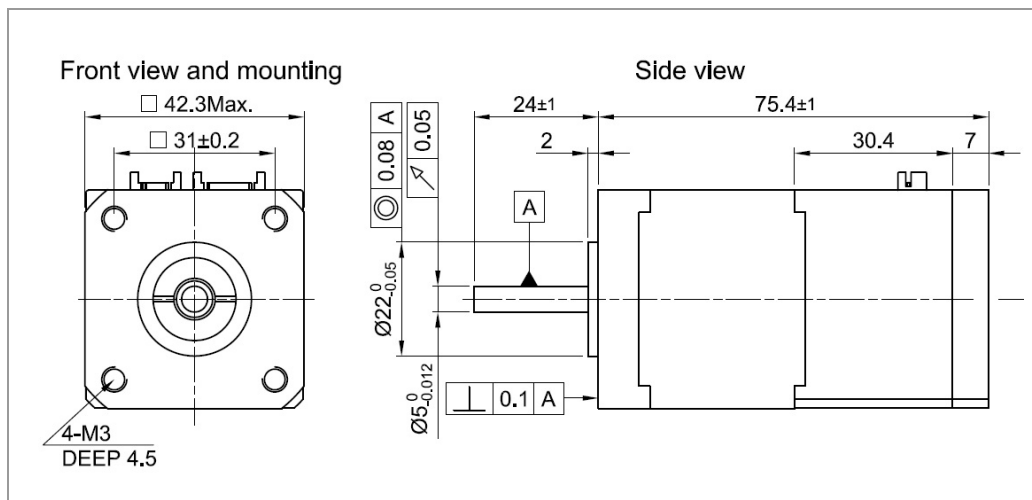

A complete set of datasheets is available for downloading at www.nanotec.com.

Overtemperature protection

At a temperature of approx. 80 °C on the board (corresponds to 72-75 °C outside on the rear motor cover), the power drive of the controller is switched off and output 3 is switch on. After the controller is cooled and restarted, it operates normally again.

The following temperature test results illustrate the temperature behavior of different Plug & Drive motors. However, the specific temperature behavior depends not only on the motor but also largely on the flanging and the heat transition at the flange, as well as on the convection in the machine. Therefore, we recommend always performing a long-term test in a realistic environment for applications with problematic levels of current and ambient temperature.

Temperature tests were performed under the following conditions:

- Operating voltage: 12 V / 24 V / 48 V DC
- Motor current: 100% (1.8 A)/150% (2.7 A)
- Operation mode: Full step speed mode, 25 rpm and 0 rpm
- Operating environment: Binder FED 53 temperature cabinet, circulated air at 100% fan speed
- Ambient temperature: 45 °C
- Test motors: PD2-N4118L1804-2
- Measurement point: rear of motors for power transistors, on the outside of the housing

The following graphics show the temperature test results:

Operating voltage 12 V (PD2-N4118L1804-2)

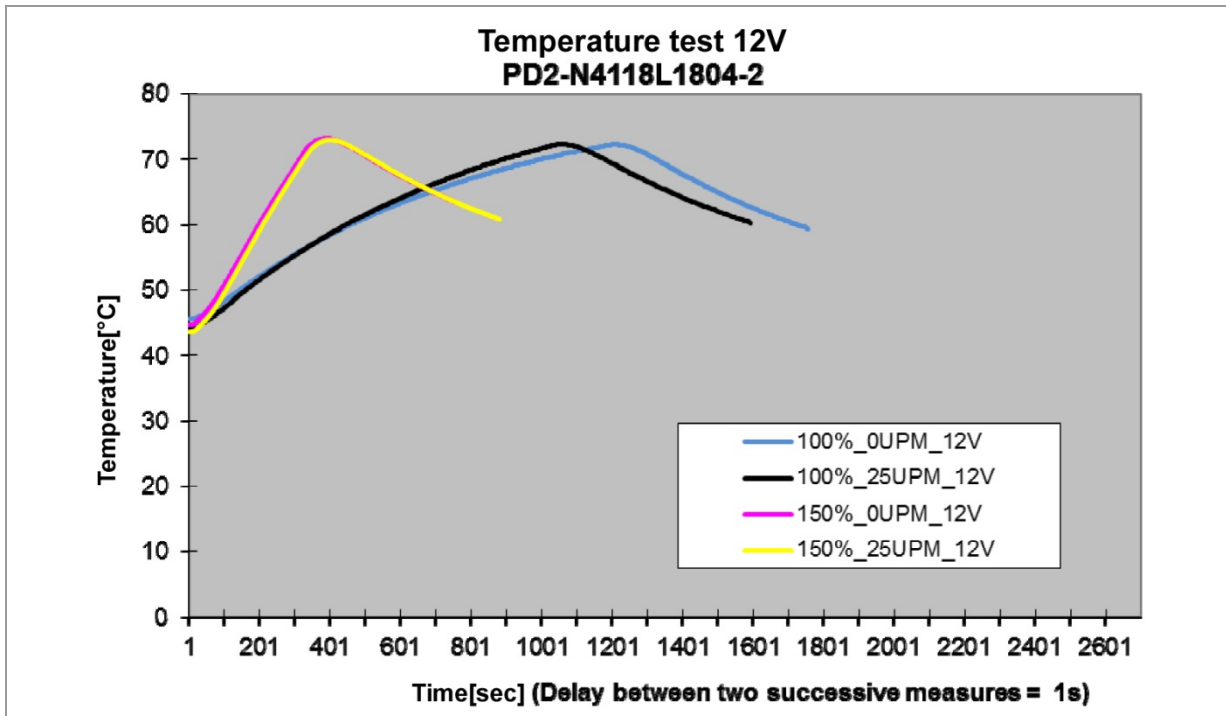

Operating voltage 24 V (PD2-N4118L1804-2)

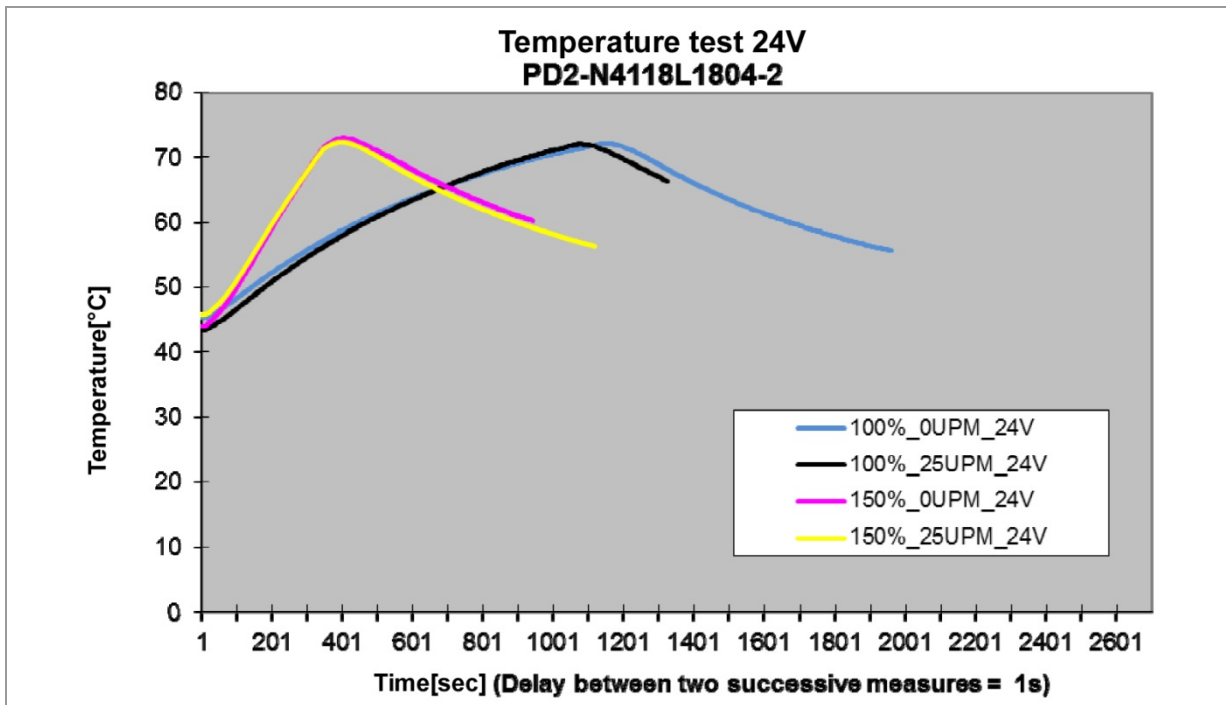

Operating voltage 48 V (PD2-N4118L1804-2)

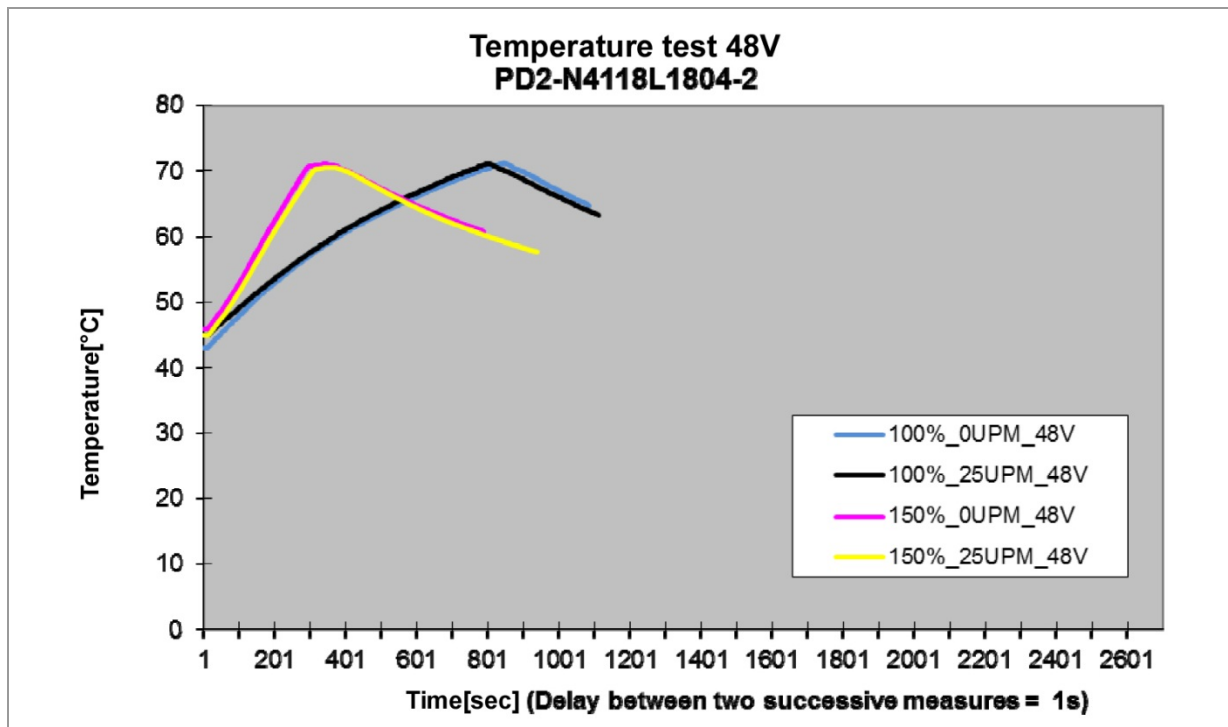

Index

A

Accessories for voltage supply 18

C

CANopen9, 15, 18

Closed loop current control.....8

Commissioning 12

D

Dimensions29

dspDrive.....8

E

Encoder9

F

Firmware.....7, 12

Functions7

H

Holding torque29

I

Input circuits 16

Inputs 16

J

JST-ZPD-10..... 18

JST-ZPD-12..... 16

N

NanoJ8

O

Operating modes

 CANopen..... 25

 serial..... 23

Operating voltage..... 18

Output circuits 17

Outputs 16

Overtemperature protection..... 30

P

Pin assignment

 JST-ZPD-10 18, 19

 JST-ZPD-12 16

Plug connections..... 10

Protective circuits..... 30

R

Rotation monitoring..... 9

RS485 network 18

T

Two-wire operation 20

V

Variants 7

Voltage supply 18

W

Weight..... 29