

Technical Manual



Plug & Drive Motors PD6-N8918

NANOTEC ELECTRONIC GmbH & Co. KG
Kapellenstraße 6
D-85622 Feldkirchen b. Munich, Germany

Tel. +49 (0)89-900 686-0
Fax +49 (0)89-900 686-50
info@nanotec.com

Editorial

© 2011

Nanotec[®] Electronic GmbH & Co. KG

Kapellenstraße 6

D-85622 Feldkirchen b. Munich, Germany

Tel.: +49 (0)89-900 686-0

Fax: +49 (0)89-900 686-50

Internet: www.nanotec.com

All rights reserved!

MS-Windows 2000/XP/Vista are registered trademarks of Microsoft Corporation.

Translation of the original operation manual

Version/Change overview

Version	Date	Changes
1.0	05/27/2009	New issue C+P
1.1	11/16/2009	Revision C+P
1.2	03/25/2010	CANopen firmware
1.3	11/03/2010	Revision RS485/CANopen
1.4	11/03/2011	External RS-485 logic supply

About this manual

Target group

This technical manual is aimed at designers and developers who need to operate a Nanotec[®] stepper motor without much experience in stepper motor technology.

Important information

This technical manual must be carefully read before installation and commissioning of the Plug & Drive motor.





Nanotec[®] reserves the right to make technical alterations and further develop hardware and software in the interests of its customers to improve the function of this product without prior notice.

This manual was created with due care. It is exclusively intended as a technical description of the product and as commissioning instructions. The warranty is exclusively for repair or replacement of defective equipment, according to our general terms and conditions; liability for subsequent damage or errors is excluded. Applicable standards and regulations must be complied with during installation of the device.

For criticisms, proposals and suggestions for improvement, please contact the above address or send an email to: info@nanotec.com

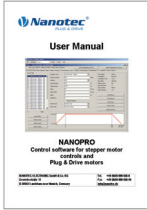
Additional manuals

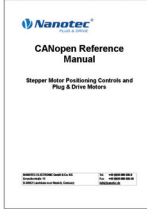
Please also note the following manuals from Nanotec:

NanoPro User Manual	Configuration of controllers with the NanoPro software	
NanoCAN User Manual	Configuration of the CAN communication for CANopen-capable controllers with the NanoCAN software	
Nanotec CANopen reference	Detailed documentation of the CANopen functions	
Programming manual	Controller programming <ul style="list-style-type: none"> • Command reference • NanoJ • COM interface 	

The manuals are available for download at www.nanotec.com.

Contents

1	Overview	5
2	Connection and commissioning	7
2.1	Connection diagram	7
2.2	Commissioning.....	9
3	Connections and circuits	13
3.1	Signal cable.....	13
3.2	Power cord	15
3.3	RS485 network/CANopen	16
3.4	External logic supply	21
4	Operating modes.....	22
4.1	Serial operating modes	22
4.2	CANopen operating modes.....	24
5	Troubleshooting.....	25
6	Technical data	27
	Index.....	29

1 Overview

Introduction

The Plug & Drive motor PD6-N8918 includes, in addition to the integrated power end stage, a complete, network-capable Closed-Loop speed and positioning control.

The PD6-N8918 not only significantly reduces development and installation outlay, but also space and component requirements. It also increases flexibility, system properties and the availability of a complete drive unit. Replacement of existing drive solutions is easy with the mechanical and electrical compatibility with standard motors.

Variants

The PD6-N8918 is available in the following variants that differ in holding torque, weight and length (see Section 6 "Technical data"):

- PD6-N8918S6404
- PD6-N8918M9504
- PD6-N8918L9504

Firmware variants

The Plug & Drive motor can be operated with the following firmware variants:

- RS485 firmware
- CANopen firmware

Functions of the PD6-N8918

The Plug & Drive motor PD6-N8918 has the following functions:

- Microstep 1/1 – 1/64 Final output stage (0.014° step resolution)
- Closed-Loop current control (sinusoidal commutation via the encoder)
- Powerful DSP microprocessor for flexible I/O
- Sequence programs with NanoJ (RS485)
- Integrated encoder for rotation monitoring and Closed-Loop current control
- RS485/CANopen interface for parameterization and control (USB connection possible via converter cable ZK-RS485-USB)
- Network capability with up to 254 motors (RS485) or 127 motors (CANopen)
- Easy programming with Windows software NanoPro (RS485) or NanoCAN (CANopen)

 **ClosedLoop**

Closed-Loop current control (sinusoidal commutation via the encoder):

In contrast to conventional stepper motor positioning controls where only the motor is actuated or the position adjusted via the encoder, sinusoidal commutation controls the stator magnetic field via the rotary encoder as in a servomotor. The stepper motor acts in this operating mode as nothing more than a high pole servomotor, i.e. the classic stepper motor noises and resonances vanish. As the current is controlled, the motor can no longer lose any steps up to its maximum torque.

If the controller recognizes that the rotor is falling behind the stator field due to overload, adjustments are made with optimal field angle and increased current. In the opposite case, i.e. if the rotor is running forward due to the torque, the current is automatically reduced so that current consumption and heat development in the motor and controller are much lower compared to normal controlled operation.

 **NanoJ**

The integrated programming language NanoJ, based on the Java standard, means complete application programs can be realized on the drivers that can be executed independently without a higher-order controller.

The programs can be created, compiled directly and written to the controller with the free NanoJEasy editor.

NanoJ is only supported by the RS485 firmware.

More detailed information can be found in the separate programming manual.

Activation via CANopen

 **CANopen**

It is possible to include the stepper motor control in a CANopen environment with the PD6-N8918. The connection can be established either via 2 wires of the I/O connection cable or in a customer-specific version also via a Hummel Twintus connector.

More detailed information on this can be found in the CANopen reference and in the NanoCAN user manual.

In addition, the Plug & Drive motor via CANopen has another safety function: Even when the voltage supply of the PD6-N8918 is interrupted, the processor continues to be supplied with power via the communication line and the position data cannot be lost so that the machine does not need to be referenced after being switched on.

Settings

The operating behavior of the motor can be set and optimized according to individual requirements by setting the motor-related parameters. The parameters can be set using the NanoPro or NanoCAN software and significantly reduce commissioning time.

More detailed information on this can be found in the separate NanoPro or NanoCAN user manual.

Rotation monitoring

Even if stepper motors do not lose steps during normal operation, the integrated speed control provides additional security in all operating modes, e.g. against motor stalling or other external sources of error. The monitoring function detects a stalled motor or step loss after tenth of a step at the most (for 1.8° stepper motors with 500 pulses/rotation).

Automatic error correction is possible after the drive profile is ended or during the drive.

2 Connection and commissioning

2.1 Connection diagram

Introduction

To operate the Plug & Drive Motor, you must implement the wiring according to the following connection diagram.

Connection diagram PD6-N8918

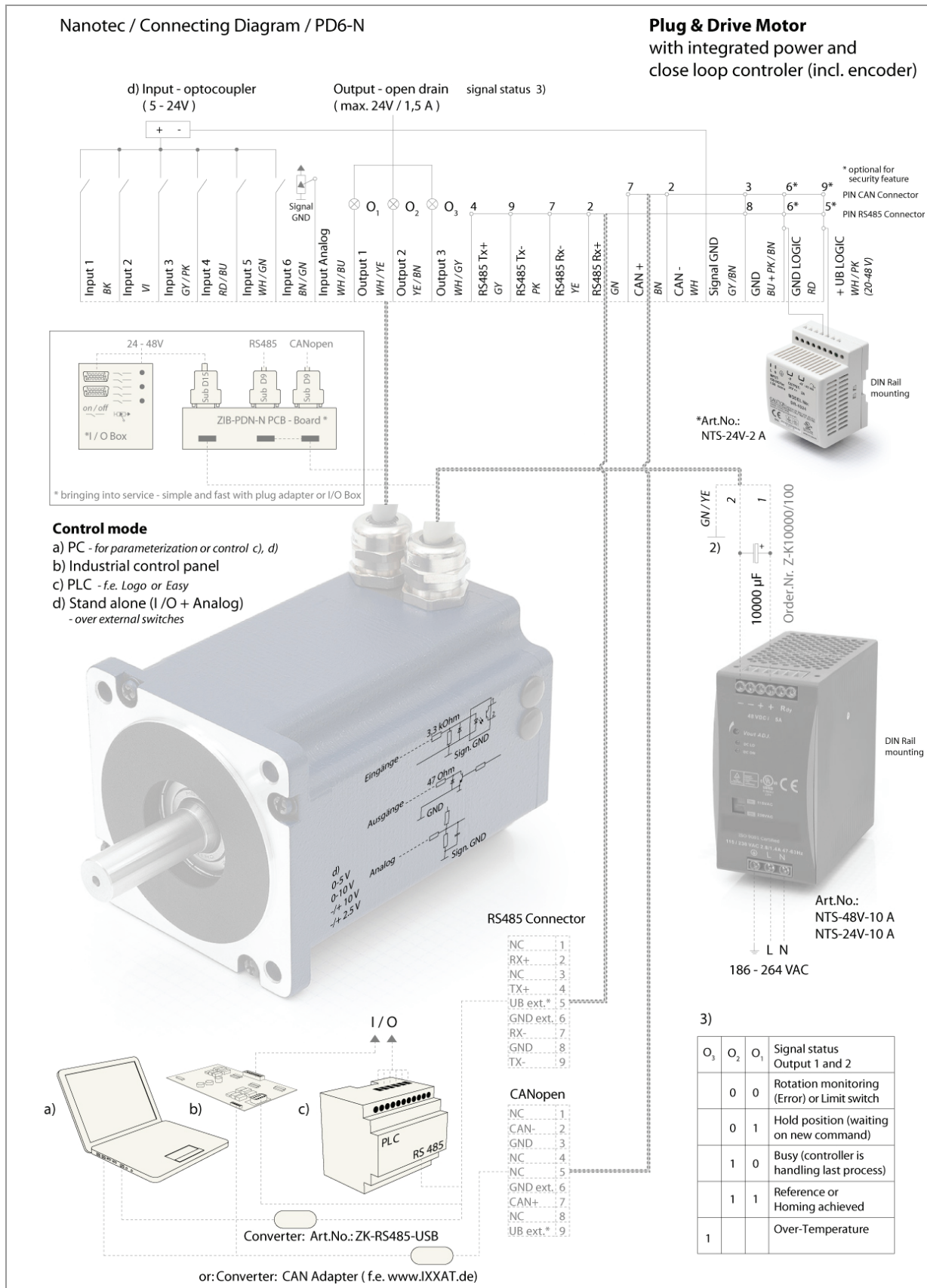

2.2 Commissioning

Provisions

The connection and commissioning of the PD6-N8918 Plug & Drive motor are described below.

This section describes the main first steps you need to take to be able to quickly begin working with the PD6-N8918 if you want to work with the NanoPro (RS485) or NanoCAN (CANopen) software from a PC. You will find more detailed information in the separate NanoPro and NanoCAN manuals.

If you want to work with a PLC or your own program later, you will find the necessary information in the separate programming manual (RS485) or in the CANopen reference (CANopen).

Familiarize yourself with the PD6-N8918 Plug & Drive motor and the relevant NanoPro or NanoCAN control software before configuring the Plug & Drive motor for your application.

Selecting the firmware

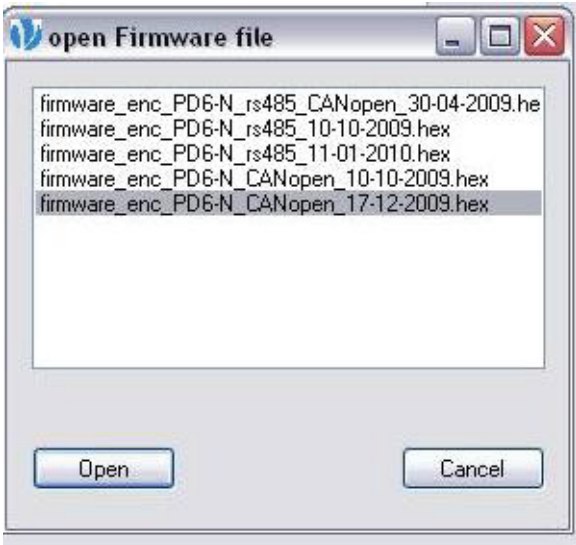

The Plug & Drive motor is always delivered with a firmware that is optimized for RS485. For the operation and configuration of the Plug & Drive motor with a CANopen interface and NanoCAN, you first need to perform a firmware update.

Proceed as follows:

Step	Action	Note
1	Install the NanoPro control software on your PC. See the NanoPro separate manual.	Download of www.nanotec.com
2	Connect the PC to the RS485 interface of the controller according to the connection diagram.	Connection diagram, see Section 2.1.
3	Open the following menu in NanoPro: <System / Change firmware / Select firmware> The following window appears: 	
4	Select the desired firmware and click on "Open".	

Commissioning with NanoPro (RS485 firmware)

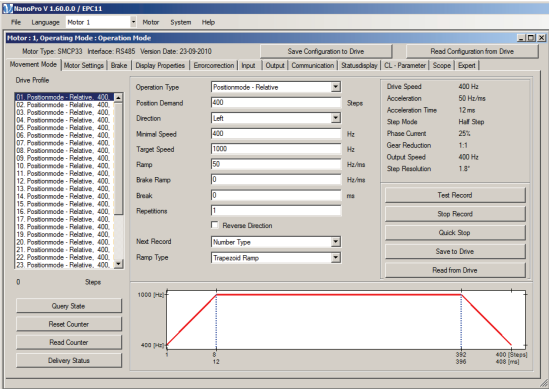
Proceed as follows to commission the Plug & Drive motor:

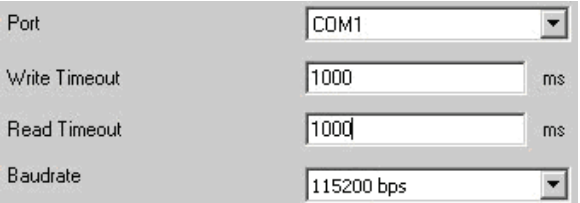
Step	Action	Note
1	Install the NanoPro control software on your PC. See the NanoPro separate manual.	Download from www.nanotec.com
2	Connect the Plug & Drive motor according to the connection diagram. For easier commissioning the ZIB-PDx-N terminal strip that already integrates the SubD connections for RS485 and CANopen can be used.	Connection diagram, see Section 2.1. Detailed information on connections can be found in Section 3.
3	Apply the operating voltage (24 V DC ... 48 V DC). CAUTION! An operating voltage > 50 V will destroy the output stage! <ul style="list-style-type: none"> Follow the information in Section 3.2. 	
4	If necessary, install the driver for the converter cable ZK-RS485-USB.	Download www.nanotec.com in the Accessories/Converter menu item
5	Connect the Plug & Drive motor with the USB port of your PC. Use the converter cable ZK-RS485-USB. Connection via the RS232 interface is not possible.	Order number: <ul style="list-style-type: none"> ZK-RS485-USB
6	Start the NanoPro software. 	The NanoPro main menu appears.
7	Select the <Communication> tab. 	
8	In the field "Port", select the COM port to which the PD6-N8918 is connected. 	The number of the COM port to which the Plug & Drive Motor is connected can be found in the device manager of your Windows PC (System Supervision/System/Hardware).

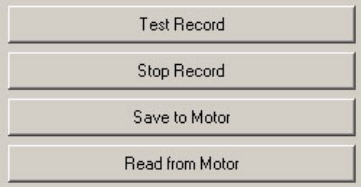
Step	Action	Note
9	Select the "115200 bps" entry in the "Baudrate" selection field.	
10	Check the current setting using the motor data sheet on the <Motor Settings> tab.	Under no circumstances may the current be set to a value higher than the rated current of the motor.
11	Select the <Movement Mode> tab. 	
12	Click on the <Test Record> button to carry out the pre-set travel profile. 	The connected motor operates with the pre-set travel profile (default travel profile after new installation).
13	You can now enter your required settings. For instance, you can enter a new travel profile.	See the NanoPro separate manual.

Commissioning with NanoCAN (CANopen firmware)

Proceed as follows to commission the Plug & Drive motor with the CANopen firmware. More detailed information can be found in the separate NanoCAN manual.

Step	Action	Note
1	Install the NanoCAN control software on your PC.	Download of www.nanotec.com
2	Connect the Plug & Drive motor according to the connection diagram.	Connection diagram, see Section 2.1. Detailed information on connections can be found in Section 3.
3	Switch on the operating voltage (24 V DC ... 48 V DC). CAUTION! An operating voltage > 50 V will destroy the output stage! <ul style="list-style-type: none"> Follow the information in Section 3.2. 	
4	Install and configure your CANopen adapter.	Details can be obtained from the manufacturer of the CANopen adapter.
5	Start the NanoCAN software.	
6	Select the desired node ID, the baud rate and, if necessary, the CAN card in the <Configuration & NMT> tab.	
7	Select the desired operating mode (e.g. PP mode) in the <Drive Modes> tab.	
8	Click on the <Power on> button.	
9	Enter the desired target position in the "target" field.	
10	Click on the <Start> button.	

3 Connections and circuits

3.1 Signal cable

Introduction

An overview of the assignments can be found in the connection diagram in Section 2.1). This section looks in detail at the assignment, functions and circuits of the signal cable.

Pin assignment

Name	Wire color
Input 1	BK
Input 2	VT
Input 3	GY/PK
Input 4	RD/BU
Input 5	WH/GN
Input 6	BN/GN
Analog input	WH/BU
Output 1	WH/YE
Output 2	YE/BN
Output 3	WH/GY
RS485 Tx +	GY
RS485 Tx –	PK
RS485 Rx –	YE
RS485 Rx +	GN
CAN +	BN
CAN –	WH
Signal GND (Com)	GY/BN
GND	BL + RS/BN
GND Logic	RD
Vcc Logic	WH/PK

Function of the inputs

All digital inputs – with the exception of the "Clock" input in the clock directional mode – can be freely programmed using the NanoPro software (RS485) (e.g. as a limit position switch, enable, etc.) and can be used for sequential control with NanoJ.

All inputs can be configured for "active-high" (PNP) or "active-low" (NPN) with NanoPro.

Input circuits

All inputs (apart from the "Analog In" input) are electrically isolated by optocouplers from the voltage supply of the PD6-N8918 and designed for 5-24 V input signals at an input current of 8 mA.

Note:

The voltage must not exceed 24 V. It should drop below 2 V for safe switching off and be at least 4.5 V for safe switching on.

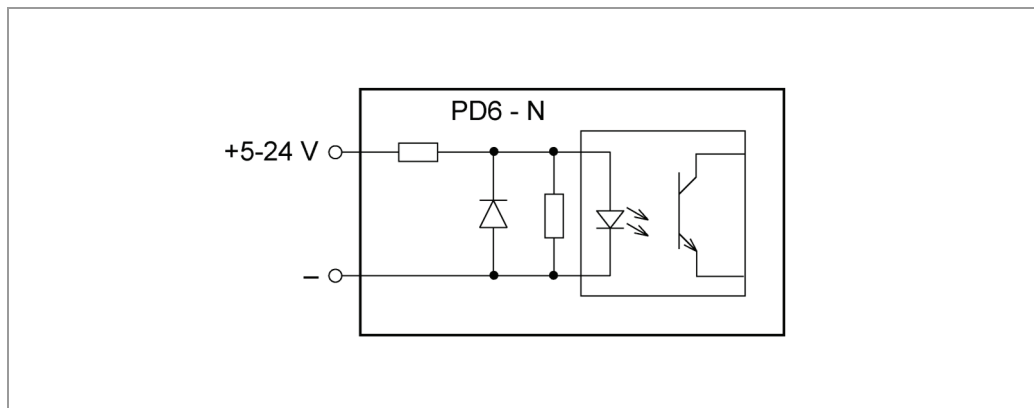

Output circuits

The outputs are MosFET outputs in an Open-Drain circuit (0 switching, max. 24 V/1.5 A). An LED can be integrated to test the output. The LED lights up when the output is active.

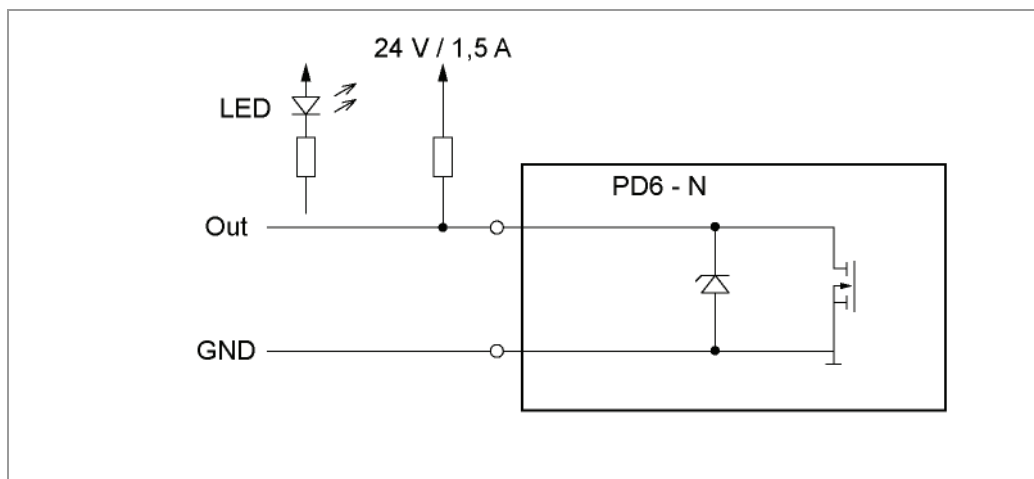

Signal states at the outputs (RS485)

Note:
In the CANopen firmware, the status of the controller is not displayed at the outputs.

The following table shows the possible signal states at the outputs 1 to 3:

Signal states			Meaning
Output 3	Output 2	Output 1	
	0	0	Rotation monitoring (error) or limit switch
	0	1	Motor idle (waiting for new command)
	1	0	Busy (control processing last command)
	1	1	Reference point or zero point reached
1			Overtemperature

The outputs can be freely programmed using the NanoPro software.

Note:
Output 3 is also used to display errors and when switching on the controller.

3.2 Power cord

Permissible operating voltage

The permissible operating voltage of the Plug & Drive Motor PD6-N8918 lies within the range +24 to +48 V DC and must not exceed 50 V or undershoot 21 V.

A charging condenser with minimum 4700 μF (10000 μF) must be provided for the operating voltage to prevent exceeding the permissible operating voltage (e.g. during braking).

	<p>Danger of electrical surges</p> <p>Connect charging condenser with minimum 4700 μF! An operating voltage > 50 V will destroy the output stage! Mixing up the connections can destroy the output stage! Never disconnect the motor when operating voltage is applied! Never disconnect lines when live!</p>
---	--

Voltage supply connection diagram

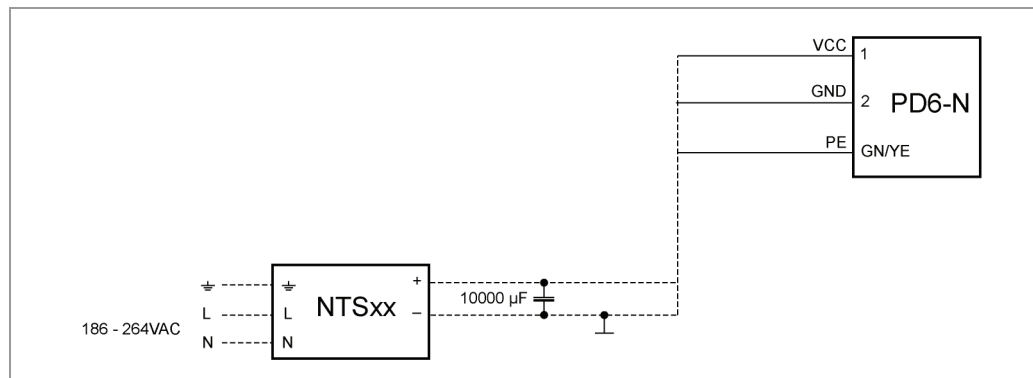

Note:
Complete connection diagram, see Section 2.1.

Pin assignment

Name	Wire number
VCC	1
GND	2
PE	GN/YE

Accessories for voltage supply

Appropriate power packs and charging condensers are available as accessories:

Name	Order identifier
Power pack	NTS-xxV-yA (xx=voltage: 24 or 48 V, y=current: 2.5, 5 or 10 A) Information on the selection of the required power supply unit can be found in our FAQ on www.nanotec.com .
Charging condenser	Z-K4700 or Z-K10000

Note: Further information about accessories can be found on the Nanotec website: www.nanotec.com

3.3 RS485 network/CANopen

PD6-N8918 in a network

Up to 254 (RS485) or 127 (CANopen) Plug & Drive motors can be actuated in a network from a PC or PLC.

These network connections are set up via the RS485/CANopen interface.

Two-wire operation RS485

To enable RS485 two-wire transmission capability, all bus stations must have a direction control.

An "intelligent" converter enables two-wire operation of the PD6-N8918 as it automatically switches to transmit operation when receiving a start bit at the RS232 interface and returns to reception standby at the end of the stop bit. This solution does not require software support.

We can recommend the ICP-7520 converter, for example, that is available from Schuricht.

Talk to our Technical Hotline if you require support for this.

Circuit diagram RS485 network

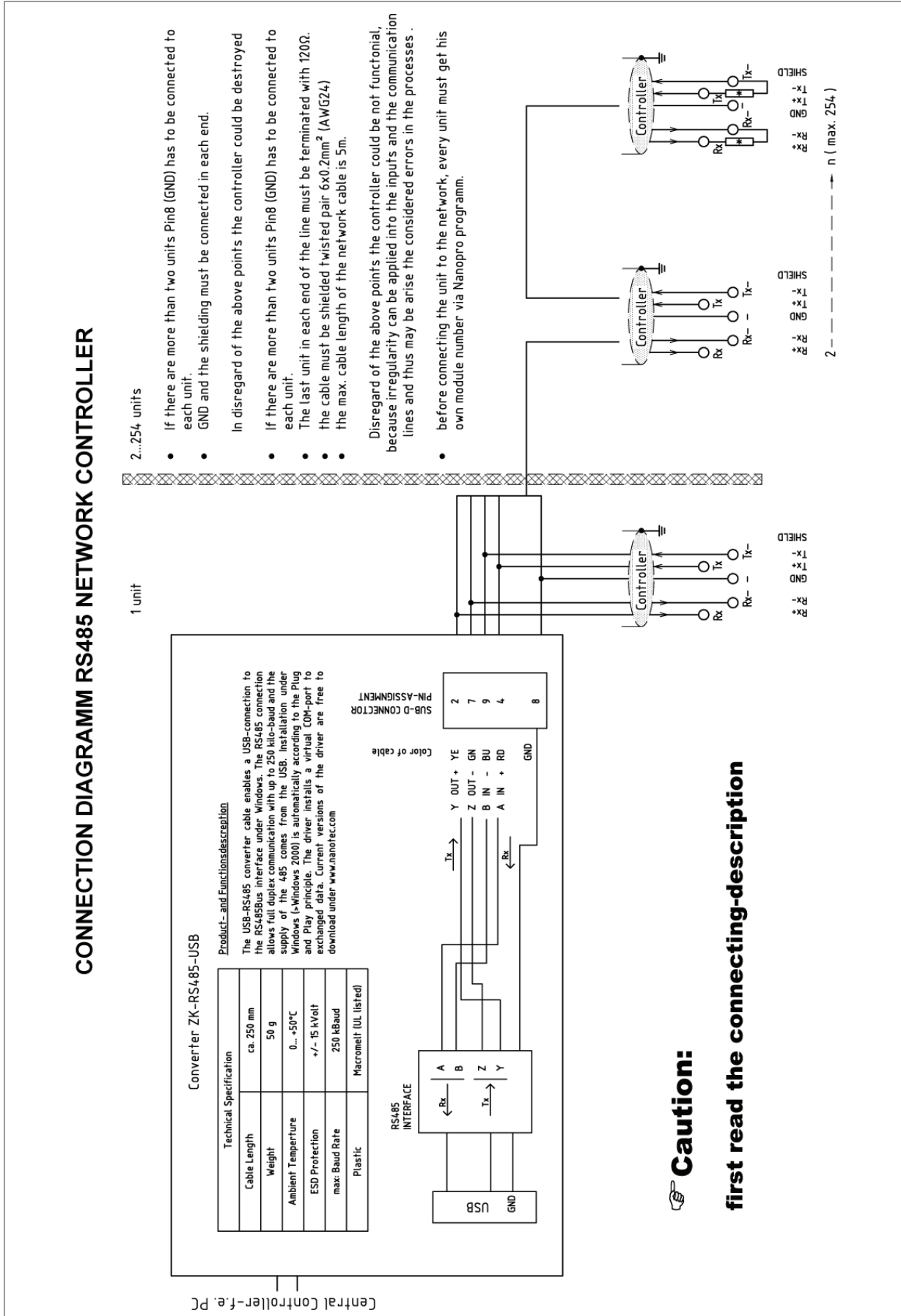

CANopen connection

A suitable CAN interface adapter (e.g. USB adapter from IXXAT or PEAK) is required for connecting with a PC.

CANopen standard connector assignment (on the adapter)

Pin no.	Name
2	CAN low
3	CAN GND
7	CAN high

CANopen connection assignments on the controller

Circuit according to the "Pin assignment" table in Section 3.1.

Notes on the baud rate

It is important to note that both the controller and the CAN master use the same baud rate. Only this way can communication be established.

The baud rate has a direct influence on the maximum possible bus length. The following list shows the possible baud rates as well as their maximum permissible bus lengths:

Baud rate	Bus length
1 MBaud	40 m
500 kBaud	130 m
250 kBaud	270 m
125 kBaud	530 m
50 kBaud	1300 m
20 kBaud	3300 m

Notes on the bus termination

With CAN, the bus termination is handled by two 120 Ohm resistors on both ends of the bus.

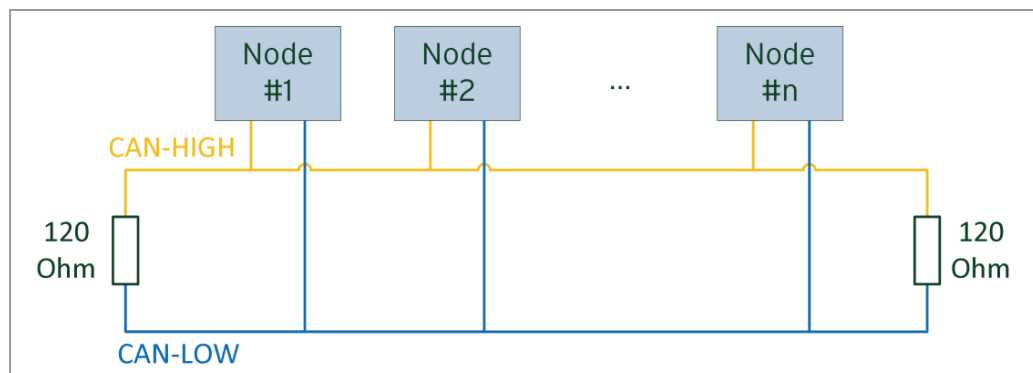

Setting the RS485 module address

Hardware setting

The RS485 module address can be set by hardware via two HEX coded switches on the printed circuit board.

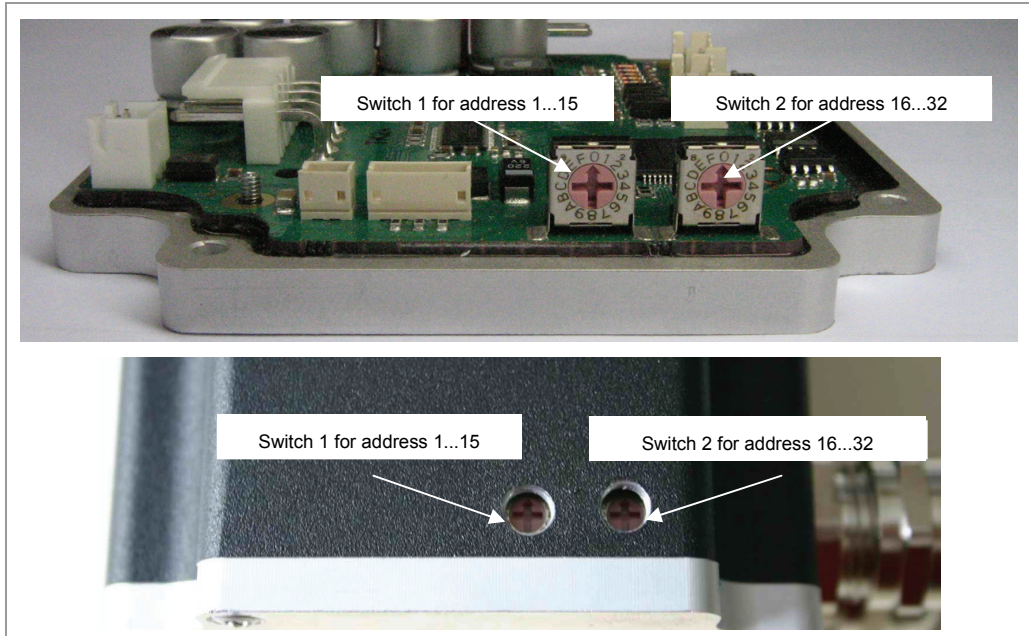

The 1st digit is set with switch 1 (left), the 16th digit of the address is set with switch 2 (right).

Module address	Switch 1 (left)	Switch 2 (right)
Software setting	0	0
1	1	0
2	2	0
...
15	F	0
16	0	1
17	1	1
...
32	0	2
...
64	0	3
...
80	0	5
...
96	0	6
...
112	0	7
...
255	F	F

When the power supply is applied, the controller checks which address is set with the 2 hardware switches. This hardware address is then adopted. After the address is changed, the power supply must be briefly switched off and on again.

Software setting

Both switches are set to 0 at delivery. With this setting, the address can be changed in the software as of firmware status 04 December 2008 or later. See the separate NanoPro manual.

Setting the CANopen module address

There are two basic ways of setting the CANopen node ID and the baud rate:

- Hardware setting: Via rotary switches on the control
- Software setting: With NanoCAN, see separate manual for NanoCAN.

To be able to make a software setting with NanoCAN, a certain value must be set on the rotary switches of the control; see the following table:

Rotary switch value dec (hex)	Node ID	Baud rate
0 (0x00)	From EEPROM	= 1 MBaud
1 - 127 (0x01 - 0x7F)	= rotary switch value	
128 (0x80)	From EEPROM	From EEPROM
129 - 255 (0x81 - 0xFF)	= rotary switch value minus 128	

Note:
The rotary switches must be set to the desired value before the control is switched on since this value is only read in when the control is restarted.

The rotary switches can be used to set a two-digit hexadecimal number (0x00 to 0xFF):

- Right-hand rotary switch: 16's place (e.g. 0xF0)
- Left-hand rotary switch: 1's place (e.g. 0x0F)

Example 1:
If the right-hand rotary switch is set to 2 and the left-hand rotary switch is set to 1 (0x21), this results in a number equivalent to the decimal number 33 (= 2*16 + 1*1).
In this case, the node ID is set to 33 on the hardware. The baud rate is set to 1 MBaud.

Example 2:
If the right-hand rotary switch is set to 8 and the left-hand rotary switch is set to 0 (0x80), this results in a number that is equivalent to the decimal number 128 (= 8*16 + 0*1).
In this case, the node ID and baud rate are read out of the EEPROM.

3.4 External logic supply

With the Plug & Drive motor you can use the additional safety feature of the separate logic supply. Even when the voltage supply of the PD6-N8918 is interrupted, the processor continues to be supplied with power via the communication line and the position data cannot be lost so that the machine does not need to be referenced after being switched on.

More detailed information on this can be found in the CANopen reference and in the NanoCAN user manual.

Notes on operating with the RS485:

Since the firmware version 04.03.11, the external logic supply also functions for RS485. If the operating voltage is disconnected, the controller switches "Not ready" status and shows the error state "Undervoltage".

4 Operating modes

4.1 Serial operating modes

Introduction

Depending on the travel profile, the motor can be operated using different operating modes. Due to the great capacity and functions available, it offers designers and developers a rapid and simple method of resolving numerous drive requirements with less programming effort.

Select the required operating mode for each drive profile and configure the controller according to your requirements.

More detailed information can be found in the separate NanoPro manual.

Overview of operating modes and their areas of application

Operation mode	Application
Relative positioning	Use this mode when you wish to travel to a specific position. The motor travels according to a specified drive profile from a Position A to a Position B.
Absolute positioning	
Internal reference run	During the internal reference run, the motor travels to an internal reference point at the set minimum speed (index mark of encoder, only in combination with an encoder).
External reference run	During an external reference run, the motor travels to a switch connected to the reference input.
Speed mode	Use this mode when you wish to travel with a specific speed (e.g. a conveyor belt or pump speed). In the speed mode, the motor accelerates with a specified ramp from the starting speed (start frequency "V Start") to the specified maximum speed (maximum frequency "V Normal"). Several inputs enable the speed to be changed on-the-fly to different speeds.
Flag positioning mode	The flag positioning mode offers a combination of the speed and positioning modes. The motor is initially operated in speed mode; when a trigger point is reached, it changes to the positioning mode and the specified setpoint position (relative to the trigger position) is approached. This operating mode is used for labeling, for example: the motor first travels with the set ramp to the synchronous speed of the conveyed goods. When the labels are detected, the preset distance (position) is traveled to apply the labels.

Operation mode	Application
Clock direction mode, left	Use this mode when you wish to operate the motor with a superordinate controller (e.g. CNC controller). In the clock direction mode, the motor is operated via two inputs with a clock and a direction signal from a superordinate positioning control (indexer). Depending on the mode selected (Int. Ref./Ext. Ref.), the internal and external reference runs are supported.
Clock direction mode, right	
Clock direction mode Int. Ref.	
Clock direction mode Ext. Ref.	
Analog and joystick mode	The motor is controlled in this operating mode simply with a potentiometer or a joystick (–10 V to +10 V). Use this mode if you want to use the motor in a simple application: <ul style="list-style-type: none"> • Setting a specific speed, e.g. via an external potentiometer, • Traveling synchronously with a superordinate controller with analog output (–10 V to +10 V).
Analogue positioning mode	Use this mode when you wish to travel to a specific position. The voltage level on the analog input is proportional to the required position.
Torque mode	Use this mode when you require a specific output torque independent of the speed as is the case in typical winding and unwinding applications. The maximum torque is specified via the analog input.

Selecting the operating mode in NanoPro

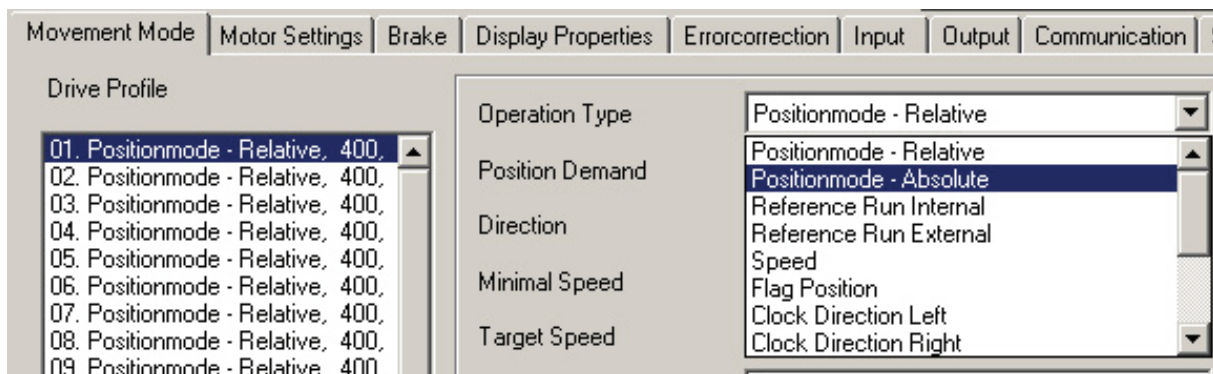

4.2 CANopen operating modes

Introduction

The motor can be operated using a total of 5 different operating modes in CANopen mode.

More detailed information can be found in the separate NanoCAN manual.

Overview of operating modes and their areas of application

Operation mode	Application
Positioning Mode (PP Mode)	Use this mode if you want to use the motor for positioning. The motor moves from A to B with the set parameters (ramp, speed, etc.).
Speed Mode (Velocity Mode)	Use this mode when you wish to travel with a specific speed (e.g. a conveyor belt).
Reference run (Ref Mode/Homing Mode)	Use this mode to reference the motor (internal/external/on block).
Interpolated Position Mode	Use this mode with a superordinate path control.
Torque Mode	Use this mode to specify a defined torque.

Selecting the operating mode in NanoCAN

In the <Drive Modes> tab the operating mode can be selected. When the tab is activated, the corresponding SDO is immediately written to the controller to activate the (possibly previously) selected operating mode.

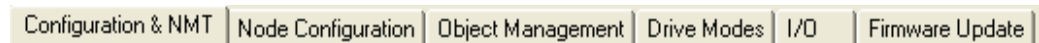

5 Troubleshooting

Troubleshooting procedure

Proceed with care during troubleshooting and error rectification to avoid damaging the Plug & Drive Motor.

	<p>Danger of electrical surges</p> <p>An operating voltage > 50 V and incorrect connections can destroy the end stage. Never disconnect the motor when operating voltage is applied! Never disconnect lines when live!</p>
---	--

Possible errors in serial mode

Error	Possible cause	Rectification
Plug & Drive Motor is not ready	Data transfer to PD6-N8918 is not possible (communication error): Incorrect COM port selected.	On the <Communication> tab, select the PC port on the PC to which you have connected the PD6-N8918 (e.g. "COM-1"). The port used can be found in the device manager of your PC.
	Communication cable not connected or interrupted (incorrect RS485 converter used).	Use the recommended RS485 converter from Nanotec: <ul style="list-style-type: none"> Order identifier: ZK-RS485-USB
	A non-existent motor number (module number) is set.	Set the correct module address. See the separate manual on NanoPro.
	The voltage supply to the PD6-N8918 is interrupted.	Check voltage supply, switch on if necessary.
	Another open program is blocking the COM port to which the PD6-N8918 is connected.	Close down other programs on your PC.
	Inadmissible data was sent to the Plug & Drive motor during the output of a travel profile.	Click on the <Yes> button to stop the travel profile. The PD6-N8918 switches to the "Ready" status. The data can then be resent to the Plug & Drive Motor.
Transmission error	The data transfer to the PD6-N8918 is disturbed (transmitter or receiver are disturbed).	Check that the motor connection is correctly wired. We recommend using the following Nanotec converters: <ul style="list-style-type: none"> ZK-RS485-USB
Position error	The motor cannot reach the position or the limit switch was overrun.	Click the <Yes> button in the error message; the error is reset.

Possible errors in CANopen mode

Error	Possible cause	Rectification
No communication with the controller	The wrong node ID has been set.	On the <Configuration & NMT> tab in NanoCAN, select the node ID that is set on the rotary switches of the controller.
	The power supply is interrupted.	Check voltage supply, switch on if necessary.
	The communication cable is not connected or is interrupted.	Check all connections, especially the terminal resistances.
Transmission error	Data transmission is disturbed (sporadically).	Switch the power supply off and on again.

6 Technical data

Electrical connections

Operating voltage V_b	DC 24 V to 48 V $\pm 4\%$
Max. phase current	Adjustable up to max. 12 A/phase Continuous current 7.5 A/phase
Current drop	Adjustable 0 to 80% of rated current
Interfaces	RS485 (4-wire) <ul style="list-style-type: none"> • 115200 bps (adjustable) • 1 start bit, 8 data bits, 1 stop bit • No parity CAN bus (CANopen) <ul style="list-style-type: none"> • 1 MBaud (adjustable)
Type of connection	PG gland, cable length = 2 m Hummel Twintus connector

Motor parameters

Step resolution	Full Step Half Step Quarter Step Fifth Step Eighth Step Tenth Step 16th step 32nd Step 64th Step Adaptive microstep (1/128) feed rate
Step angle	1.8°
Operating modes	Position Speed Flag position Clock direction Analog Joystick Torque
Step frequency	0 to 50 kHz in clock direction mode 0 to 25 kHz in all other modes
Position monitoring	Automatic error correction up to 0.18° (depending on encoder resolution)

Inputs and outputs

Inputs	6 optocouplers, 5 – 24 V <ul style="list-style-type: none"> • Safe switch off: max. 2 V • Safe switch on: min. 4.5 V Signal delay time: <ul style="list-style-type: none"> • Inputs 1 to 5: 120 µs • Input 6: 10 µs
Outputs	3 MosFET outputs <ul style="list-style-type: none"> • Open-Drain (0 switching, max. 24 V/1.5 A) • Signal delay time: output 1/2: ≈ 12 µs (with 10 kΩ-Pull-Up at 24 V)

Protective circuits

Overvoltage and undervoltage	Protective circuit for voltages > 50 V or < 21 V
Max. heatsink temperature	Approx. 67 °C
Max. ambient temperature	0 to 40 °C

Holding torque, weight and dimensions

Variants	Holding torque (Nm)	Weight (kg)	Length "L" (mm)
PD6-N8918S6404	3.2	1.7	89
PD6-N8918M9504	5.94	3.4	121
PD6-N8918L9504	9.33	3.95	151

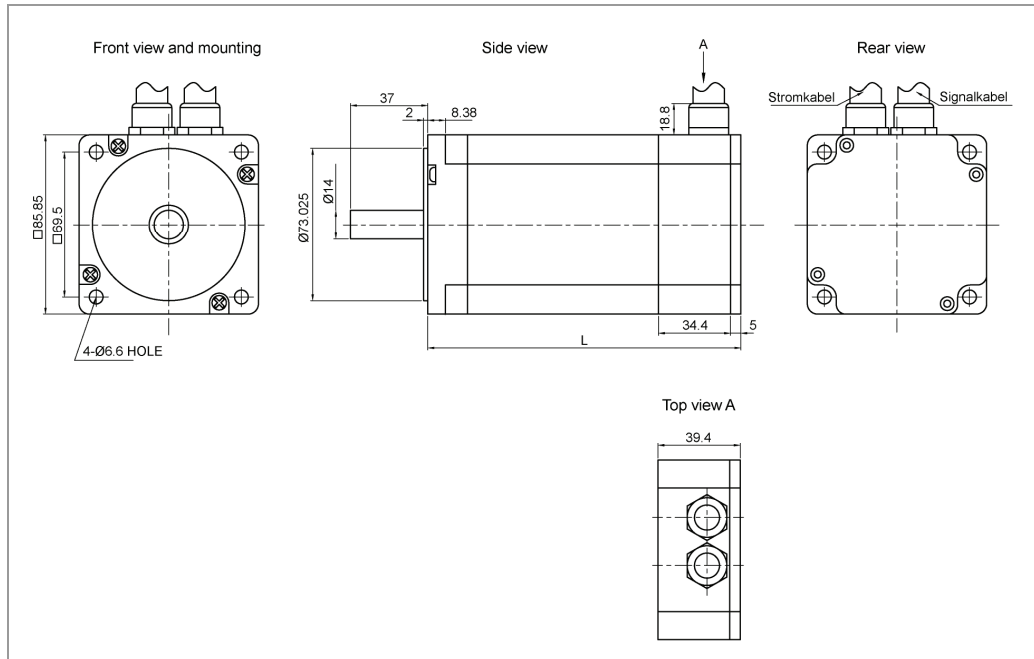

A complete set of datasheets is available for downloading at www.nanotec.com.

Index

A

Accessories for voltage supply 15

C

CANopen 6, 12, 16

Closed-Loop current control 6

Commissioning 9

Connection diagram 8

D

Dimensions 28

E

Encoder 7

F

Firmware 5, 9

Functions 5

H

Holding torque 28

I

Input circuits 13

Inputs and outputs 13

L

Logic supply 21

N

NanoJ 6

O

Operating modes 22

 CANopen 24

 serial 22

Operating voltage 15

Output circuits 14

P

Pin assignment

 Power cord 15

 Signal cable 13

Power cord 15

R

Rotation monitoring 7

RS485 network 16

S

Signal cable 13

T

Two-wire operation 16

V

Variants 5

Voltage supply 15

W

Weight 28