

# Manual N5

Fieldbus: CANopen

**For use with the following devices:**

- N5-1-2
- N5-2-2



Valid with firmware version FIR-v1504  
and since hardware version W005

NANOTEC ELECTRONIC GmbH & Co. KG  
Kapellenstraße 6  
85622 Feldkirchen/Munich, Germany

Manual Version 1.3.0

Tel. +49 (0)89-900 686-0  
Fax +49 (0)89 900 686-50  
info@nanotec.com

# Contents

<b>1 Editorial.....</b>	<b>7</b>
<b>2 Safety instructions and warnings.....</b>	<b>8</b>
2.1 Important information.....	8
2.2 Personnel qualifications.....	8
2.3 Danger and warning signs.....	8
2.4 Other information.....	9
<b>3 About this manual.....</b>	<b>10</b>
3.1 Introduction.....	10
3.2 Numerical values.....	10
3.3 Bits.....	10
3.4 Counting direction (arrows).....	10
3.5 Version notes.....	11
<b>4 Technical data and pin configuration.....</b>	<b>12</b>
4.1 Dimensioned drawings.....	12
4.2 Electrical properties.....	12
4.3 LED signaling.....	13
4.4 Pin configuration.....	14
<b>5 Configuration.....</b>	<b>21</b>
5.1 General information.....	21
5.2 NanoJ program.....	21
5.3 CANopen.....	21
5.4 Ethernet interface.....	23
<b>6 Setup and commissioning.....</b>	<b>28</b>
6.1 Safety instructions.....	28
6.2 Preparation.....	28
6.3 CANopen set up and installation.....	28
6.4 Ethernet.....	30
<b>7 General concepts.....</b>	<b>32</b>
7.1 DS402 Power State machine.....	32
7.2 User-defined units.....	36
<b>8 Operating modes.....</b>	<b>39</b>
8.1 Profile Position.....	39
8.2 Velocity.....	45
8.3 Profile Velocity.....	46
8.4 Profile Torque.....	49
8.5 Homing.....	50
8.6 Cyclic Synchronous Position.....	57
8.7 Cyclic Synchronous Velocity.....	59

8.8 Cyclic Synchronous Torque.....	60
8.9 <b>Clock/direction mode</b> .....	61
8.10 Auto-setup mode.....	62
<b>9 Special functions.....</b>	<b>65</b>
9.1 Digital inputs and outputs.....	65
9.2 Automatic brake controller.....	67
9.3 I <sup>2</sup> t motor overload protection.....	70
9.4 Save Objects.....	71
<b>10 Programming with NanoJ.....</b>	<b>75</b>
10.1 Introduction.....	75
10.2 Available computing time.....	75
10.3 Sandbox.....	75
10.4 Loading a NanoJ program.....	76
10.5 Interaction of the user program with the motor controller.....	77
10.6 OD entries for controlling and configuring the VMM.....	78
10.7 NanoJ Easy V2.....	79
10.8 System calls.....	82
<b>11 Object directory description.....</b>	<b>84</b>
11.1 Overview.....	84
11.2 Structure of the object description.....	84
11.3 Object description.....	84
11.4 Value description.....	85
11.5 Description.....	86
1000h Device Type.....	87
1001h Error Register.....	88
1003h Pre-defined Error Field.....	88
1005h COB-ID Sync.....	92
1007h Synchronous Window Length.....	92
1008h Manufacturer Device Name.....	92
1009h Manufacturer Hardware Version.....	93
100Ah Manufacturer Software Version.....	93
100Ch Guard Time.....	94
100Dh Live Time Factor.....	94
1010h Store Parameters.....	95
1011h Restore Default Parameters.....	96
1014h COB-ID EMCY.....	97
1017h Producer Heartbeat Time.....	98
1018h Identity Object.....	98
1400h Receive PDO 1 Communication Parameter.....	99
1401h Receive PDO 2 Communication Parameter.....	100
1402h Receive PDO 3 Communication Parameter.....	101
1403h Receive PDO 4 Communication Parameter.....	102
1600h Receive PDO 1 Mapping Parameter.....	102
1601h Receive PDO 2 Mapping Parameter.....	105
1602h Receive PDO 3 Mapping Parameter.....	107
1603h Receive PDO 4 Mapping Parameter.....	109
1800h Transmit PDO 1 Communication Parameter.....	111
1801h Transmit PDO 2 Communication Parameter.....	113
1802h Transmit PDO 3 Communication Parameter.....	114
1803h Transmit PDO 4 Communication Parameter.....	115
1A00h Transmit PDO 1 Mapping Parameter.....	117
1A01h Transmit PDO 2 Mapping Parameter.....	119
1A02h Transmit PDO 3 Mapping Parameter.....	121

1A03h Transmit PDO 4 Mapping Parameter.....	123
2005h CANopen Baudrate.....	126
2009h CANopen NodeID.....	126
2010h IP-Configuration.....	127
2011h Static-IPv4-Address.....	127
2012h Static-IPv4-Subnet-Mask.....	128
2014h Current-IPv4-Address.....	129
2015h Current-IPv4-Subnet-Mask.....	130
2030h Pole Pair Count.....	131
2031h Peak Current.....	132
2032h Maximum Speed.....	132
2033h Plunger Block.....	133
2034h Upper Voltage Warning Level.....	133
2035h Lower Voltage Warning Level.....	134
2036h Open Loop Current Reduction Idle Time.....	134
2037h Open Loop Current Reduction Value/factor.....	135
2038h Brake Controller Timing.....	135
2039h Motor Currents.....	137
203Ah Homing On Block Configuration.....	138
203Bh I2t Parameters.....	139
2050h Encoder Alignment.....	141
2051h Encoder Optimization.....	142
2052h Encoder Resolution.....	143
2053h Index Polarity.....	143
2054h Index Width.....	144
2056h Limit Switch Tolerance Band.....	144
2057h Clock Direction Multiplier.....	145
2058h Clock Direction Divider.....	145
2059h Encoder Configuration.....	145
205Ah Encoder Boot Value.....	146
205Bh Clock Direction Or Clockwise/Counter Clockwise Mode.....	147
2060h Compensate Polepair Count.....	147
2061h Velocity Numerator.....	148
2062h Velocity Denominator.....	148
2063h Acceleration Numerator.....	149
2064h Acceleration Denominator.....	149
2065h Jerk Numerator.....	150
2066h Jerk Denominator.....	150
2067h Jerk Limit (internal).....	151
2084h Bootup Delay.....	151
2101h Fieldbus Module.....	152
2200h Sampler Control.....	153
2201h Sampler Status.....	153
2202h Sample Data Selection.....	154
2203h Sampler Buffer Information.....	156
2204h Sample Time In Ms.....	157
2300h NanoJ Control.....	158
2301h NanoJ Status.....	158
2302h NanoJ Error Code.....	159
2303h Number Of Active User Program.....	160
2304h Table Of Available User Programs.....	161
230Fh Uptime Seconds.....	163
2310h NanoJ Input Data Selection.....	163
2320h NanoJ Output Data Selection.....	167
2330h NanoJ In/output Data Selection.....	170
2400h NanoJ Inputs.....	174
2410h NanoJ Init Parameters.....	180
2500h NanoJ Outputs.....	186
2600h NanoJ Debug Output.....	191

3202h Motor Drive Submode Select.....	203
320Ah Motor Drive Sensor Display Open Loop.....	204
320Bh Motor Drive Sensor Display Closed Loop.....	205
3210h Motor Drive Parameter Set.....	206
3212h Motor Drive Flags.....	209
3220h Analog Inputs.....	210
3221h Analogue Inputs Control.....	211
3225h Analogue Inputs Switches.....	212
3240h Digital Inputs Control.....	213
3250h Digital Outputs Control.....	215
3320h Read Analogue Input.....	216
3321h Analogue Input Offset.....	217
3322h Analogue Input Pre-scaling.....	218
3700h Following Error Option Code.....	219
4040h Drive Serial Number.....	220
603Fh Error Code.....	220
6040h Controlword.....	221
6041h Statusword.....	222
6042h VI Target Velocity.....	223
6043h VI Velocity Demand.....	223
6044h VI Velocity Actual Value.....	224
6046h VI Velocity Min Max Amount.....	224
6048h VI Velocity Acceleration.....	225
6049h VI Velocity Deceleration.....	226
604Ah VI Velocity Quick Stop.....	227
604Ch VI Dimension Factor.....	228
605Ah Quick Stop Option Code.....	229
605Bh Shutdown Option Code.....	229
605Ch Disable Option Code.....	230
605Dh Halt Option Code.....	231
605Eh Fault Option Code.....	231
6060h Modes Of Operation.....	232
6061h Modes Of Operation Display.....	233
6062h Position Demand Value.....	233
6063h Position Actual Internal Value.....	233
6064h Position Actual Value.....	234
6065h Following Error Window.....	234
6066h Following Error Time Out.....	235
6067h Position Window.....	235
6068h Position Window Time.....	236
606Bh Velocity Demand Value.....	236
606Ch Velocity Actual Value.....	237
606Dh Velocity Window.....	237
606Eh Velocity Window Time.....	238
6071h Target Torque.....	238
6072h Max Torque.....	239
6074h Torque Demand.....	239
607Ah Target Position.....	239
607Bh Position Range Limit.....	240
607Ch Home Offset.....	241
607Dh Software Position Limit.....	241
607Eh Polarity.....	242
6081h Profile Velocity.....	243
6082h End Velocity.....	243
6083h Profile Acceleration.....	244
6084h Profile Deceleration.....	244
6085h Quick Stop Deceleration.....	244
6086h Motion Profile Type.....	245
6087h Torque Slope.....	245

608Fh Position Encoder Resolution.....	246
6091h Gear Ratio.....	247
6092h Feed Constant.....	248
6098h Homing Method.....	248
6099h Homing Speed.....	249
609Ah Homing Acceleration.....	250
60A4h Profile Jerk.....	250
60C2h Interpolation Time Period.....	252
60C5h Max Acceleration.....	253
60C6h Max Deceleration.....	253
60F2h Positioning Option Code.....	254
60F4h Following Error Actual Value.....	255
60FDh Digital Inputs.....	255
60FEh Digital Outputs.....	256
60FFh Target Velocity.....	257
6502h Supported Drive Modes.....	257
6503h Drive Catalogue Number.....	259
6505h Http Drive Catalogue Address.....	259

## **12 Copyright notice..... 260**

12.1 Introduction.....	260
12.2 AES.....	260
12.3 Arcfour (RC4).....	260
12.4 MD5.....	261
12.5 uIP.....	261
12.6 DHCP.....	261
12.7 CMSIS DSP Software Library.....	262
12.8 FatFs.....	262
12.9 Protothreads.....	262
12.10 Lightweight IP.....	263

# 1 Editorial

Copyright © 2014 Nanotec Electronic GmbH & Co. KG. All rights reserved.

The firmware in our motor controllers may contain software components produced by third parties. The licensing conditions and copyrights of these code components can be found in the "**Copyright notice**" section.

Nanotec<sup>®</sup> Electronic GmbH & Co. KG

Kapellenstraße 6

85622 Feldkirchen/Munich, Germany

Tel.: +49 (0)89-900 686-0

Fax: +49 (0)89-900 686-50

Internet: [www.nanotec.com](http://www.nanotec.com)

All rights reserved!

MS Windows 98/NT/ME/2000/XP/7 are registered trademarks of the Microsoft Corporation.

**Translation of original manual**

## 2 Safety instructions and warnings

### 2.1 Important information

This technical manual must be carefully read before installation and commissioning of the motor controller.

Nanotec<sup>®</sup> reserves the right to make technical alterations and further develop hardware and software in the interests of its customers to improve the function of this product without prior notice.

This manual was created with due care. It is exclusively intended as a technical description of the product and as commissioning instructions. The warranty is exclusively for repair or replacement of defective equipment, according to our general terms and conditions; liability for subsequent damage or errors is excluded. Applicable standards and regulations must be complied with during installation of the device.

To submit criticism, proposals and suggestions for improvement, please contact the above address or send an email to: [info@nanotec.com](mailto:info@nanotec.com)

### 2.2 Personnel qualifications

Work on and with this product may only be carried out by skilled workers

- who are familiar with and have understood the contents of this manual
- who have completed a training course or have the corresponding experience to be able to estimate, predict, or identify any dangers that may arise from using the motor controller
- who are familiar with all applicable standards, legal provisions, and accident-prevention regulations that have to be complied with when working on and with the product
- who are able to ensure personal safety when using the motor controller in an overall system

Operation may only be carried out when the specified cables and corresponding accessories are used. Use only original accessories and original spare parts.

### 2.3 Danger and warning signs

All signs listed in this documentation are printed in a standardized form. A hazardous situation is categorized according to the classes below depending on the level of hazard to the user or motor controller.

#### **DANGER**

The DANGER sign indicates an immediately hazardous situation that, when the instruction is neglected, will **unavoidably** cause a serious or fatal accident.

#### **WARNING**

The WARNING sign indicates a potentially hazardous situation that, when the instruction is neglected, may **possibly** cause a serious or fatal accident or damage to this device or other devices.

#### **CAUTION**

The CAUTION sign indicates a potentially hazardous situation that, when the instruction is neglected, may **possibly** cause an accident or damage to this device or other devices.



## CAUTION

The CAUTION sign without the warning symbol indicates a possibly hazardous situation that, when the instruction is neglected, may **possibly** cause an accident or damage to this device or other devices.

### 2.4 Other information

The following additional information panels are used in this documentation:

**Tip** This panel indicates a possibility for simplifying work.

#### Note

This panel indicates possible error sources or risks of confusion.

---

#### Example

This panel contains an example.

---

## 3 About this manual

### 3.1 Introduction

This manual is directed toward programmers intending to program a motor controller using the motor controller from Nanotec®.

### 3.2 Numerical values

Numerical values are always presented in decimal notation. If hexadecimal notation must be used, this is indicated by a subscript "h" at the end of the number.

The objects in the object directory are noted as follows with an index and subindex:  
<Index>:<Subindex>

Both the index and subindex are in hexadecimal notation. Subindex 0 is in force when no subindex is noted.

Example: Subindex 5 of object 1003<sub>h</sub> is addressed with "1003<sub>h</sub>:05<sub>h</sub>", subindex 0 of object 6040<sub>h</sub> with "6040<sub>h</sub>".

In the last section of the manual, all objects are listed in full, and the references in the running text and tables are set in bold, e.g. **6040<sub>h</sub>**.

### 3.3 Bits

The individual bits of an object are always numbered beginning with 0 at the LSB. See the following figure, which uses the "UNSIGNED8" data type as an example.

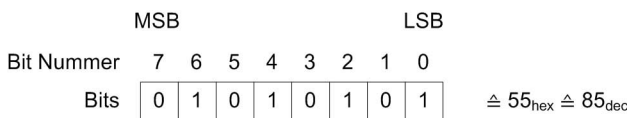

### 3.4 Counting direction (arrows)

In drawings, the counting direction is always in the direction of the arrow. The objects 60C5<sub>h</sub> and 60C6<sub>h</sub> shown in the following figure are both positive.

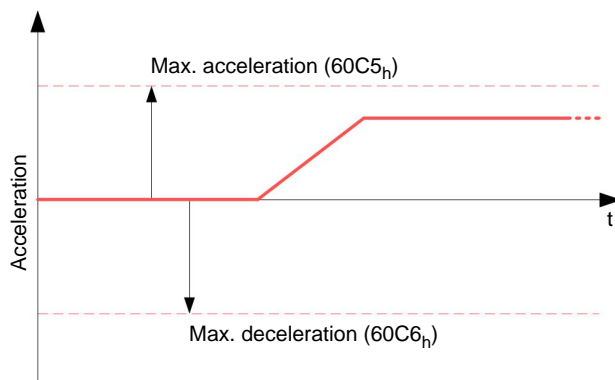

### 3.5 Version notes

Version Manual	Version Firmware	Date	Changes
1.0.0	FIR-v1417	30.04.2014	Published
1.0.3	FIR-v1419	12.05.2014	Small corrections, assignment of OD entries is now correct
1.1.0	FIR-v1426	16.05.2014	The following sections were added: <ul style="list-style-type: none"> <li>• <b>Cyclic Synchronous Position</b></li> <li>• <b>Cyclic Synchronous Velocity</b></li> <li>• <b>Cyclic Synchronous Torque</b></li> </ul>
1.2.0	FIR-v1426	23.07.2014	<ul style="list-style-type: none"> <li>• Added chapter "<b>Save Objects</b>", added "Persistent" to the object description</li> <li>• The following objects has been moved <ul style="list-style-type: none"> <li>• "Read Analog Input": from 6402<sub>h</sub> to 3320<sub>h</sub></li> <li>• "Analogue Input Offset": from 6431<sub>h</sub> to 3321<sub>h</sub></li> <li>• "Analogue Input Pre-scaling": from 6432<sub>h</sub> to 3322<sub>h</sub></li> </ul> </li> </ul>
1.2.7	FIR-v1436	10.09.2014	Corrections
1.2.15	FIR-v1446	18.11.2014	<ul style="list-style-type: none"> <li>• Corrections</li> <li>• The object "Mode of modulo operation" at 2070<sub>h</sub> has been replaced with object "Positioning option code" at <b>60F2<sub>h</sub></b></li> </ul>
1.2.16	FIR-v1450	26.01.2015	<p>The following objects have been moved:</p> <ul style="list-style-type: none"> <li>• "Current-IPv4-Address": from 2018<sub>h</sub> to <b>2014<sub>h</sub></b></li> <li>• "Current-IPv4-Subnet-Mask": from 2019<sub>h</sub> to <b>2015<sub>h</sub></b></li> <li>• "Drive Serial Number": from 2022<sub>h</sub> to <b>4040<sub>h</sub></b></li> </ul> <p>The following objects have been removed:</p> <ul style="list-style-type: none"> <li>• "AppInfo-Static-IP-Address" 2020<sub>h</sub></li> <li>• "AppInfo-Static-Subnet-Mask" 2021<sub>h</sub></li> </ul>
1.3.0	FIR-v1504	11.03.2015	<p>New chapter:</p> <ul style="list-style-type: none"> <li>• <b>Clock/direction mode</b></li> </ul>

## 4 Technical data and pin configuration

### 4.1 Dimensioned drawings

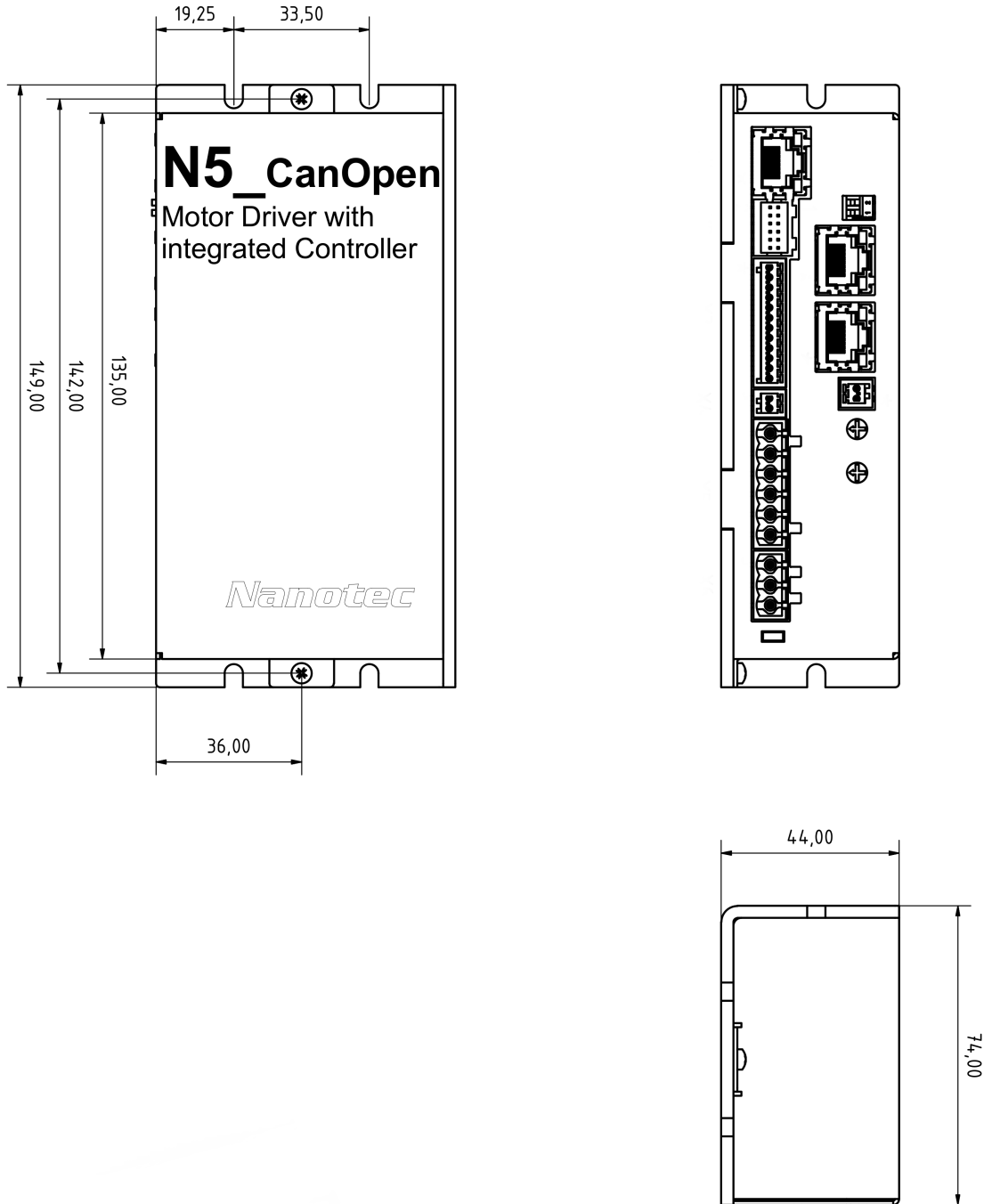

### 4.2 Electrical properties

Operating voltage	12 V - 48 V DC (Low Current-Version), or 12 V - 48 V DC (High Current-Version)
Continuous current	10 A effective (Low Current-Version), or 18 A effective (High Current-Version)

Peak current	10 A effective (Low Current-Version), or 54 A effective (High Current-Version)
Commutation	Stepper motor open loop, stepper motor closed loop with encoder, BLDC sinus-commutated via hall sensor, BLDC sinus-commutated via encoder
Operating mode	<ul style="list-style-type: none"> <li>• Profile Position</li> <li>• Velocity</li> <li>• Profile Velocity</li> <li>• Profile torque</li> <li>• Homing</li> <li>• Cyclic Sync Position</li> <li>• Cyclic Sync Velocity</li> <li>• Cyclic Sync Torque</li> <li>• Clock/direction mode</li> <li>• Application program (NanoJ)</li> </ul>
Parameterization	Browser-based via Ethernet with the NanoIP interface
Field bus interfaces	CANopen
Encoder input	5 V or 24 V signal, differential or single-ended (switchable via software), max. resolution 65536 cycles per revolution (16 bit), UVW connection for hall sensor
Inputs	<ul style="list-style-type: none"> <li>• 4 inputs 5 V/24 V (input 1 to 4) separately switchable via software, default setting is 5 V</li> <li>• 2 wide-range inputs 5–24 V (inputs 5 and 6);</li> <li>• 2 analog inputs -10 to +10 V or 0–20 mA (switchable via software)</li> </ul>
Outputs	2 transistor outputs (open drain, 0-switching, max. 24 V/0.5 A)
Brake	<p>1 open drain output, max. 1.5 A</p> <p>Overvoltage and undervoltage:            Protective circuit at voltage &gt; 77.5 V or &lt; 9 V (Low Current-Version)            Protective circuit at voltage &gt; 52.4 V or &lt; 9 V (Low Current-Version)            Overtemperature: protective circuit at temperature &gt; 70° C</p> <p>Polarity reversal protection: in case of polarity reversal, short circuit between supply voltage and GND via PIN diode, therefore cable protection device (fuse) required in supply cable. The interrupting rating of the fuse depends on the application and has to be</p> <ul style="list-style-type: none"> <li>• greater than the maximum controllers current consumption</li> <li>• and smaller than the maximum current of the voltage supply.</li> </ul> <p>In case the fuse being close to the current consumption of the controller, the fuse characteristic should be slow-blow.</p>

## 4.3 LED signaling

### 4.3.1 Normal operation

In normal operation the greenoperating LED flashes very briefly once per second.

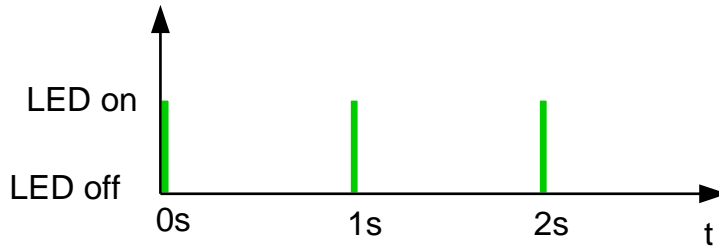

### 4.3.2 Error

Should there be an error, an error number is indicated by the LED within one second. In the following illustration, the error is signaled with the number 3.

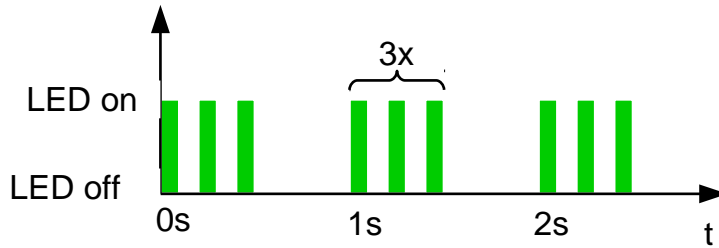

The meaning of the error number is printed in the following table.

Amount Flash	Error
1	General information
2	Voltage
3	Temperature
4	Overcurrent
5	Control

#### Note

A considerably more exact error code is stored in object **1003<sub>h</sub>** for every error that has occurred.

## 4.4 Pin configuration

### 4.4.1 Overview

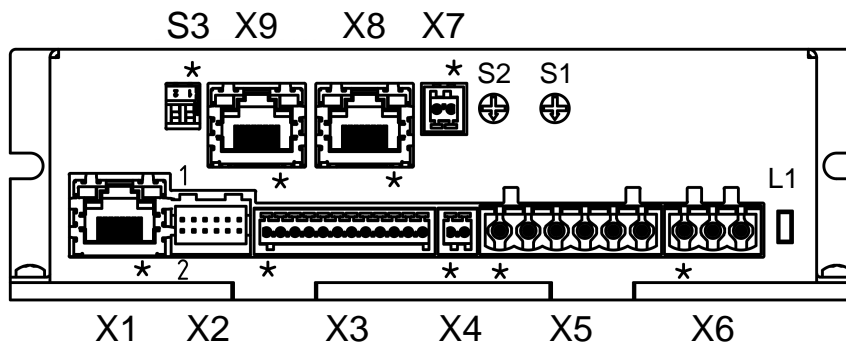

Connector	Function
X1	Ethernet
X2	Encoder
X3	Input and output

Connector	Function
X4	Brake
X5	Motor connection
X6	Supply voltage
X7	External logic supply, input voltage +24 V DC Supply voltage for encoder, input voltage +24 V DC
X8	CANopen IN
X9	CANopen OUT
S1	Hex coding switch for node ID, 16's place (e.g. 0x <b>F</b> 0)
S2	Hex coding switch for node ID, 1's place (e.g. 0x0 <b>F</b> )
S3	PIN1            120 ohm terminating resistance (switch at ON) PIN2            Reserved
L1	Operating LED

#### 4.4.2 Ethernet (connector X1)

Pin 1 is marked with an asterisk "\*".

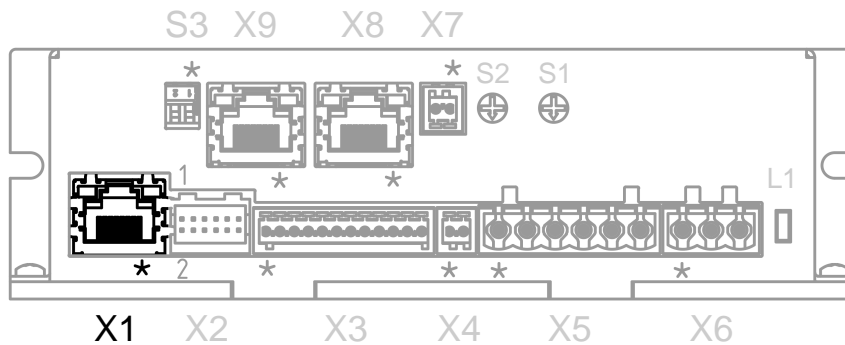

#### 4.4.3 Encoder input (connector X2)

##### Note

Two types of encoder are supported:

1. Encoder with a supply voltage of 5 V. In this case nothing needs to be connected to connector X7 , the object **2059<sub>h</sub>** must be set to the value "0".
2. Encoder with a supply voltage of 24 V. In this case a voltage of 24 V DC needs to get connected to the connector X7 (see **Encoder voltage supply (connector X7)** ), the object **2059<sub>h</sub>** must be set to the value "1".

Pin 1 and Pin 2 are marked in the diagram.

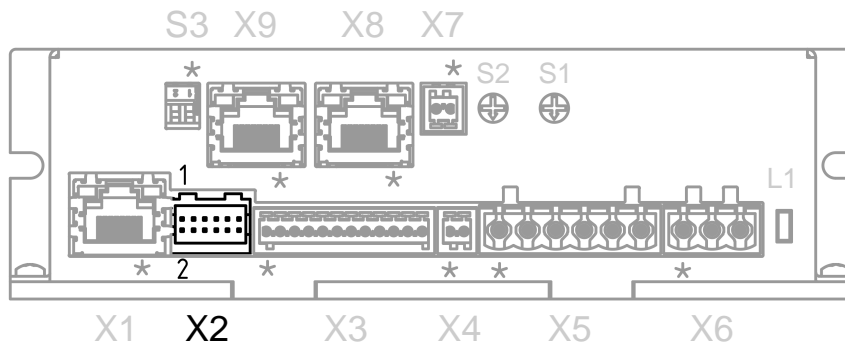

PIN	Function	Remark
1	GND	

PIN	Function	Remark
2	Vcc	+5 V DC (standard) or +24 V DC, output voltage switchable via software with object <b>2059<sub>h</sub></b> .
3	A	
4	B	
5	A\	
6	B\	
7	I	
8	I\	
9	Hall 1	
10	Hall 2	
11	Hall 3	
12	Shielding	Shielding

#### 4.4.4 Digital inputs and outputs (connector X3)

Pin 1 is marked with an asterisk "\*".

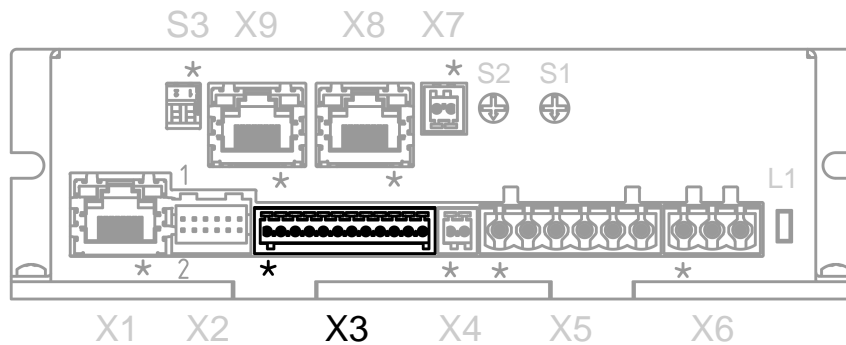

PIN	Function	Remark
1	GND	
2	Input 1	Digital input, 5 V / 24 V, switchable via software with object <b>3240<sub>h</sub></b>
3	Input 2	Digital input, 5 V / 24 V, switchable via software with object <b>3240<sub>h</sub></b>
4	Input 3	Digital input, 5 V / 24 V, switchable via software with object <b>3240<sub>h</sub></b> , directional input in clock/direction mode
5	Input 4	Digital input, 5 V / 24 V, switchable via software with object <b>3240<sub>h</sub></b> , clock input in clock/direction mode
6	Input 5	Digital input, 5 V to 24 V, not switchable via software
7	Input 6	Digital input, 5 V to 24 V, not switchable via software
8	Analog input 1	-10 V...+10 V or 0...20 mA, switchable via software with object <b>3221<sub>h</sub></b>
9	Analog input 2	-10 V...+10 V or 0...20 mA, switchable via software with object <b>3221<sub>h</sub></b>
10	Output 1	Digital output, open drain, max. 24 V/0.5 A
11	Output 2	Digital output, open drain, max. 24 V/0.5 A
12	Shielding	Shielding

#### 4.4.5 Brake output (connector X4)

Pin 1 is marked with an asterisk "\*".



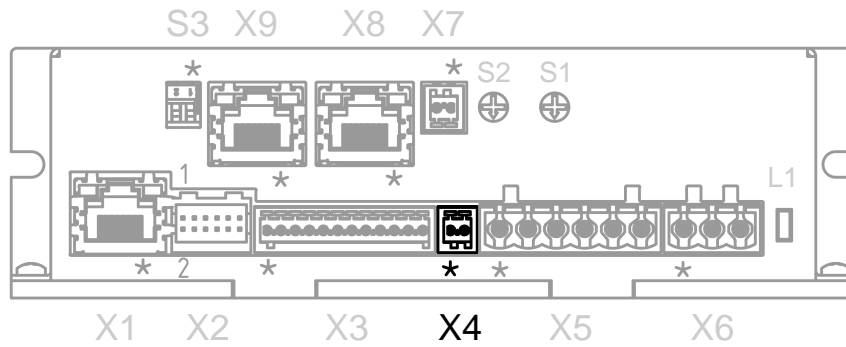

PIN	Function	Remark
1	Brake +	Internally connected with +UB
2	Brake -	PWM-controlled open drain output, max. 1.5 A

#### 4.4.6 Motor connection (connector X5)

Pin 1 is marked with an asterisk "\*".

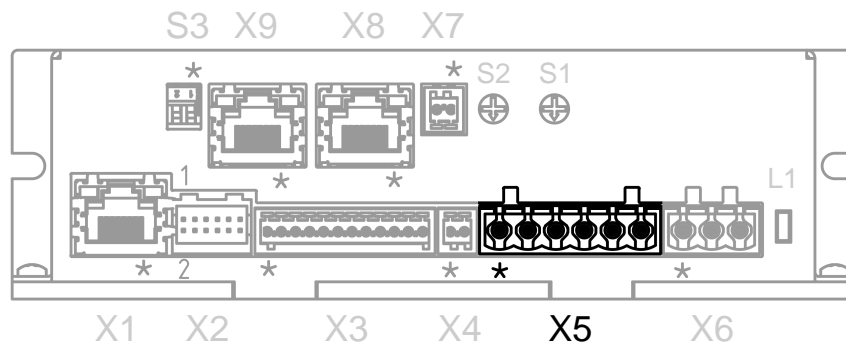

PIN	Function	Function	Remark
	Stepper	BLDC	
1	Shielding	Shielding	Shielding
2	A	U	
3	A\	V	
4	B	W	
5	B\	n.c.	
6	Shielding	Shielding	Shielding

#### 4.4.7 Motor controller voltage supply (connector X6)

##### Safety instruction



##### Danger of electrical overvoltage!

- An operating voltage that is higher than the values specified above will destroy the output stage. Mixing up the connections can destroy the output stage.
- Never connect or disconnect lines when live!
- The supply voltage must be selected so that it never exceeds the admissible operating voltage of the motor. Specifically, interference from other consumers or interference caused by the voltages induced by the motor must be taken into consideration here, and a voltage may need to be selected that offers sufficient safety reserves.

### Voltage source

The operating or supply voltage is delivered by a battery, by a transformer with rectification and filtering, or better yet, by a switch-mode power supply.

Interference suppression and protection measures are required when a DC power supply line with a length of >30 m is used or the motor is used on a DC bus. An EMI filter must be added to the DC supply cable as close to the motor controller/motor as possible.

Long data or supply lines are to be routed through ferrites.

### Connections

Pin 1 is marked with an asterisk "\*".

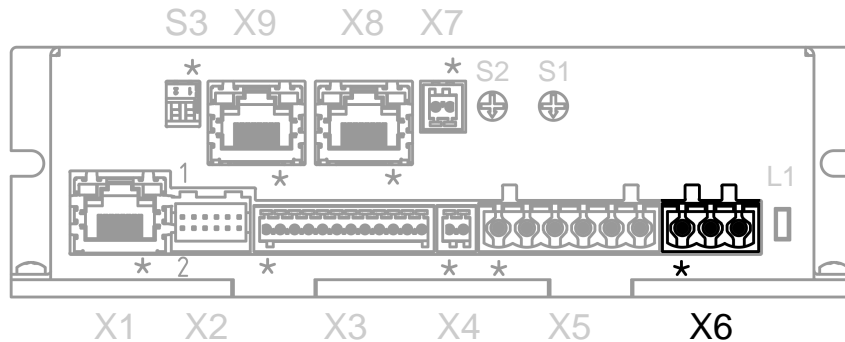

PIN	Function	Remark
1	Shielding	Shielding
2	+VB	12-70 V DC (Low Current-Version) 12-48 V DC (High Current-Version)
3	GND	

#### 4.4.8 Encoder voltage supply (connector X7)

##### Functionality

The supply voltage at connector X7 has to be connected under the following circumstances:

1. A 24 V encoder is used. In this case, a supply voltage of 24 V DC needs to be connected to X7 and the object **2059<sub>h</sub>** has to be set to the value "1".
2. It is necessary to use a logic supply voltage to use the following functions, even in case of a collapse of the supply voltage at connector X6 (see "**Motor controller voltage supply (connector X6)**"):
  - Logical function of controller
  - Communication with controller
  - Encoder

### CAUTION

The coils of the motor **are not supplied by the logic supply voltage**, the motor will coast if the supply voltage at X6 collapses. Depending on the load at the axis of the motor, it is possible that the motor may **accelerate!**

In this case, a supply voltage of 24 V DC has to be connected to X7. If a 24 V-encoder is used, the object **2059<sub>h</sub>** has to be set to the value "1". In case of a 5 V-encoder the object **2059<sub>h</sub>** has to be set to the value "0".

### Connector

Pin 1 is marked with an asterisk "\*".

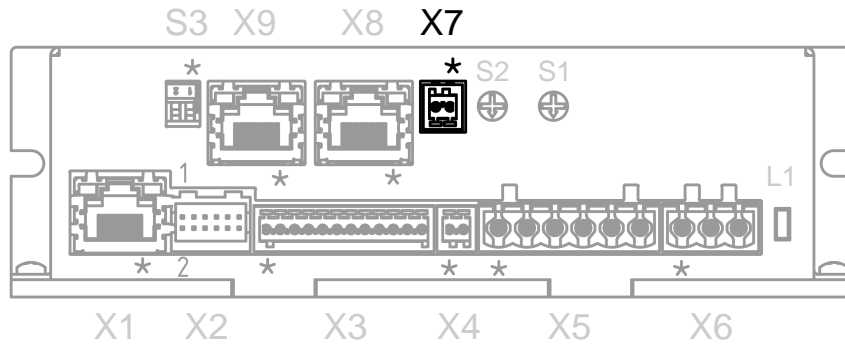

PIN	Function	Remark
1	+VB logic/ encoder	+24 V DC, supply voltage for logic and encoder
2	GND	

#### 4.4.9 CANopen Bus IN (connector X8)

Pin 1 is marked with an asterisk "\*".

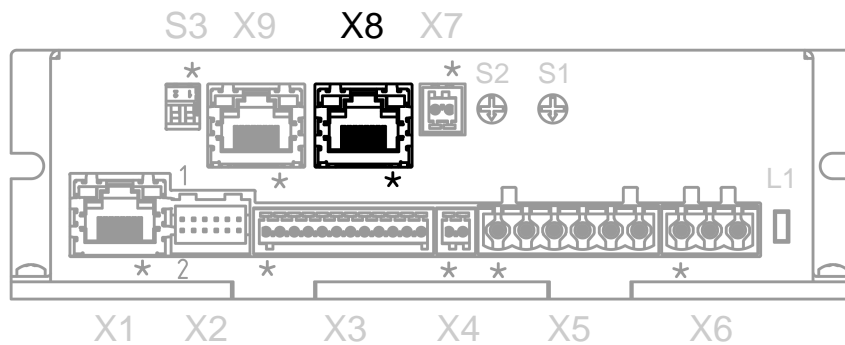

PIN	Function	Remark
1	CAN_H	
2	CAN_L	
3	CAN_GND	Connected with PIN 7 inside
4	n.c.	
5	n.c.	
6	CAN_SHLD	
7	GND	Connected with PIN 3 inside
8	+VB Logic	+24 V DC

#### 4.4.10 CANopen Bus OUT (connector X9)

Pin 1 is marked with an asterisk "\*".

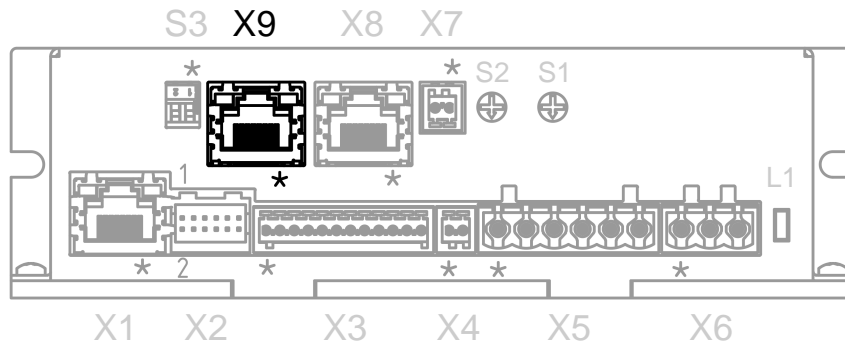

PIN	Function	Remark
1	CAN_H	
2	CAN_L	
3	CAN_GND	Connected with PIN 6 and PIN 7 inside
4	n.c.	
5	n.c.	
6	CAN_SHLD	Connected with PIN 3 and PIN 7 inside
7	GND	Connected with PIN 3 and PIN 6 inside
8	+VB Logic	+24 V DC

## 5 Configuration

### 5.1 General information

The following options exist for configuring the motor controller:

#### NanoJ program

This program can be programmed with NanoJ Easy, compiled and then written to the motor controller via Ethernet. Read the sections and "**NanoJ program**"

#### CANopen NodeID and the terminating resistor

This motor controller is fitted with the CANopen field bus that can be configured with an adjuster wheel on the rear. A DIP-switch for terminating is fitted next to it. Read the "**CANopen**" section for details.

#### Ethernet

This motor controller is equipped with an Ethernet interface and can be configured on the NanoIP device homepage. Read the "**Ethernet interface**" section for details.

### 5.2 NanoJ program

A NanoJ program may be executed on the motor controller. Carry out the following steps to load and launch a program on the motor controller:

1. Write and compile your program as described in the "**Programming with NanoJ**" section.
2. Connect the voltage supply to connector X6 (see the "**Motor controller voltage supply (connector X6)**" section) and switch on the voltage supply.
3. Connect the motor controller to your PC via an Ethernet cable.
4. Open the NanoIP web interface with a web browser and copy the file onto the motor controller (details in the "**Ethernet interface**" section.).
5. On the NanoIP web interface, you can now change to the "NanoJ" tab, select the program and start it.

### 5.3 CANopen

#### 5.3.1 Rotary switch

The motor controller has two integrated rotary switches S1 and S2. It can be used to set the source for the CANopen NodeID and the baud rate.

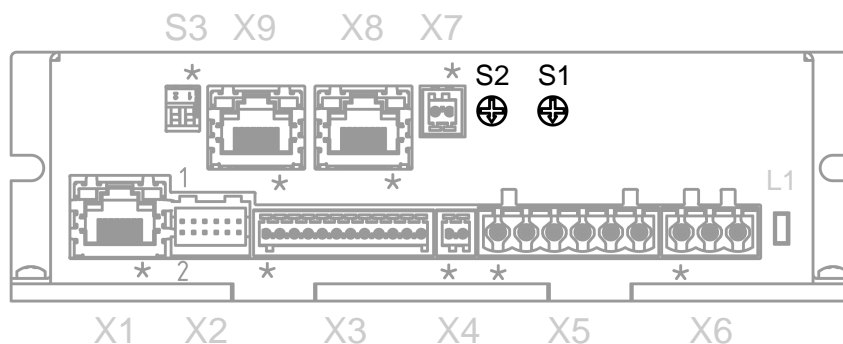

The following applies: S1 is the higher-value byte, while S2 is the lower value byte.

#### Example

- S1 = 0<sub>h</sub>, S2 = F<sub>h</sub>, this results in the figure 0F<sub>h</sub> = 16<sub>d</sub>
- S1 = A<sub>h</sub>, S2 = 1<sub>h</sub>, this results in the figure A1<sub>h</sub> = 161<sub>d</sub>

The NodeID can either be applied as a value from the adjuster wheel or read from object **2009<sub>h</sub>**.

The baud rate is either fixed at 1 MBd or is read out from object **2005<sub>h</sub>**.

#### Note

- If the rotary switch is permanently set to the value "1", the NodeID is "1" and the baud rate is permanently set to 1 MHz. Should there be problems with the configuration, the value "1" always establishes communication with the motor controller and any errors can be undone.
- The changes to the objects **2005<sub>h</sub>** and **2009<sub>h</sub>** must always be saved ; this is done by writing the value 65766173<sub>h</sub> into object **1010<sub>h</sub>:2<sub>h</sub>**.
- The changes are adopted after
  - After the voltage supply is briefly disconnected
  - Or the CANopen message "RESET COMM" (NMT) is sent to the motor controller

### 5.3.2 NodeID

The following table shows a summary of the options for the rotary switch..

Number of rotary switches		NodeID
hex	dec	
0	0	Object <b>2009<sub>h</sub></b>
1-7F	1-127	Rotary switch number
80	128	Object <b>2009<sub>h</sub></b>
81-FF	129-255	(Rotary switch number)-128

### 5.3.3 Baud rate

Number of rotary switches		Baud rate
hex	dec	
0	0	1 MBd fixed
1-7F	1-127	1 MBd fixed
80	128	Object <b>2005<sub>h</sub></b>
81-FF	129-255	Object <b>2005<sub>h</sub></b>

The value of **2005<sub>h</sub>** can be taken from the following table.

Value of <b>2005<sub>h</sub></b>		Baud rate
hex	dec	in kBd
81	129	10
82	130	20
83	131	50
84	132	125
85	133	250
86	134	500
88	136	1000

### 5.3.4 Terminating resistor

The motor controller contains a switch for the terminating resistance (S3, Pin 1 is marked with a "\*" in the figure, Pin 2 is not used). If the switch position is at "ON", the line is terminated with 120 Ohm.

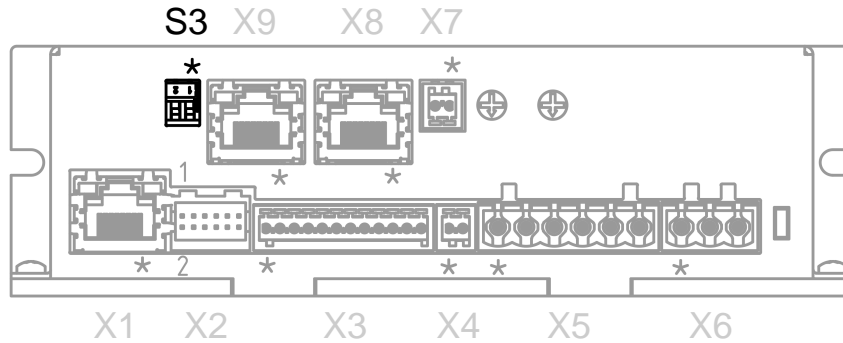

## 5.4 Ethernet interface

### 5.4.1 Overview

#### Notes

### CAUTION

Accesses onto the web server of the motor controller have **no** guaranteed execution and response times.

In extreme cases, these times may span several seconds. Therefore, access via the web server is **not** suitable for directly actuating the motor and should **only** be used for startup/commissioning/diagnosis or troubleshooting.

#### Interface

The motor controller is equipped with a 10/100 MBit Ethernet interface. In this way it can be operated with all current Ethernet components (switches, PCs) and configured via the "NanoIP" web interface. This interface is also used to update the firmware via the "NanoFlash" tool.

#### Connection

If the motor controller is correctly connected to the other Ethernet components, the green LED on the Ethernet socket at connector X1 lights up.

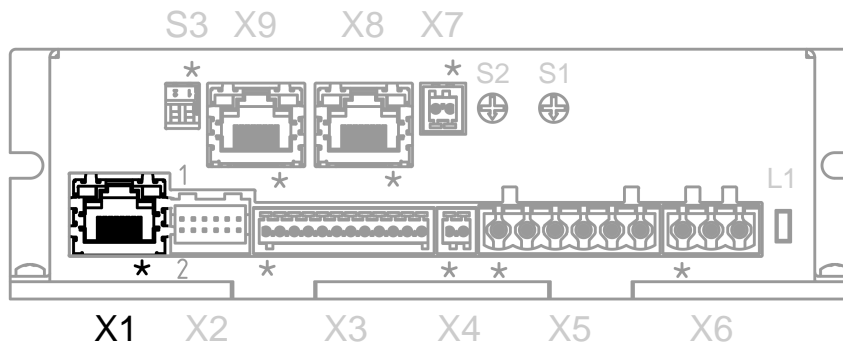

When communication occurs and data packets are received or sent, the yellow LED on the socket flashes.

## Hardware address

The motor controller does not have an IP address but is addressed via the hardware address printed on it (= MAC address). This address consists of 6 hex numbers with the syntax 44-AA-E8-xx-xx-xx.

The hardware address is unique and permanent, and is assigned during production. Usually it is only needed for the firmware update using NanoFlash. As soon as the bootloader has closed and the actual firmware goes into operation, communication is set forth via the TCP/IP protocol.

## IP address

For this the motor controller requires a valid IP address. It can be obtained by the following methods:

- Static IP address: This address is defined by the user in NanoIP.
- DHCP: A DHCP server assigns the IP address to the motor controller.
- AutoIP: The motor controller autonomously determines a suitable IP address. This requires that the communication partner is located in the same subnetwork and that it also uses AutoIP.

Which method is used depends on the network environment and is defined by the network operator.

## 5.4.2 Integration in an existing network

### Existing network

The motor controller can be readily integrated in an existing Ethernet network. This simply requires that the physical connection be established via the standard Ethernet cable. If DHCP and UPnP are activated on the motor controller (preset at the factory), the motor controller is automatically detected in the network and can immediately be operated using a PC into the network.

### Motor controller in Windows Explorer

In the Windows Explorer, the motor controller can then simply be selected and the web interface can be started by double-clicking. In this case, it is not necessary to define a manual IP address.

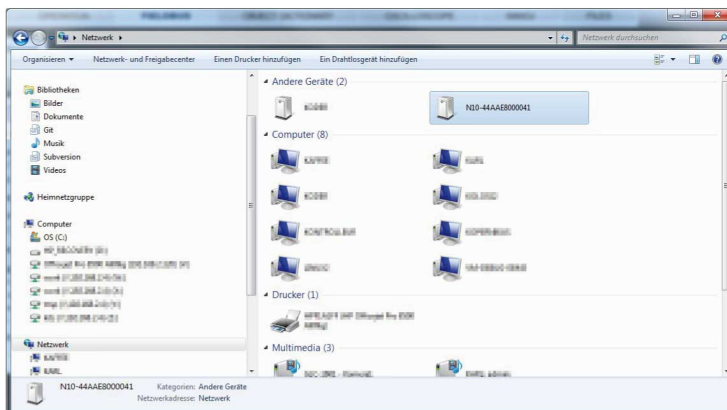

### PC direct connection

If a DHCP server is not available or if the motor controller does not appear in the Windows network environment for other reasons, an IP address must be manually assigned. .

Access to the user interface is then possible either by entering the IP address in the browser, or if UPnP is available, via the network environment.

## 5.4.3 OD entries for Ethernet

### Object entries

For the function of the Ethernet, the following entries in the object directory are essential:



Index	Description
<b>2010<sub>h</sub></b>	IP configuration, bitmask with the following meaning: Bit 0: static IP address Bit 1: UPnP activated Bit 2: DHCP activated Bit 3: Auto IP activated Bit 4: IP activated Bit 16: The IP address was set by NanoFlash Standard value: 0E <sub>h</sub> (UPnP, DHCP, AutoIP and IP activated)
<b>2011<sub>h</sub></b>	Static IP address, 4 bytes in hex coding
<b>2012<sub>h</sub></b>	Static IP subnet mask, 4 bytes in hex coding
<b>2014<sub>h</sub></b>	Active IP address, 4 bytes in hex coding
<b>2015<sub>h</sub></b>	Active IP subnetwork mask, 4 bytes in hex coding
<b>6503<sub>h</sub></b>	Drive catalogue number/MAC address

#### Remarks

- If the web interface is started with the assistance of NanoFlash, the motor controller receives a temporary IP address with the associated subnet mask. It can be found in **2014<sub>h</sub>/2015<sub>h</sub>**. With the Bit 16 of the object **2010<sub>h</sub>** is signaled, that the IP address was set by NanoFlash.
- If DHCP is activated and Auto IP is not active, the motor controller uses the set static IP address if no address could be assigned via DHCP (e.g. because the DHCP server is temporarily unavailable).

### 5.4.4 REST interface

#### Introduction

The web server protocol is HTTP/1.0. The architecture is implemented according to REST (Representational State Transfer) and makes it possible to access the web interface as well as other objects/resources. One example are the values in the object directory.

The supported operations are:

- GET: Requirements of a resource
- POST: Addition of a new resource
- PUT: Creation or changing of a new resource
- DELETE: Deletion of the resource

#### Resource name

The name of a resource is always specified in the URI (Uniform Resource Identifier) notation known from the Internet. Via this URI, the motor controller supports access to the filesystem (see "**Access to the file system**") and the object dictionary (see "**Access to the object directory**"). The identifiers are:

- Od: Object directory
- Fs: File system

#### Example

Access to a value in the object directory

`http://192.168.2.100/od/6040/00`

This string is used to access the entry **6040<sub>h</sub>** subindex 0 in the object directory.

The response is in the form of a JSON String and reflects the content of this object.

### Access to the file system

The following URIs enable access to the file system:

#### <IP address>/fs

Lists the root directory.

#### <IP address>/fs/dir

Lists the subdirectory.

#### <IP address>/fs/dir/file.xxx

Requests the "file .xxx" file from the "dir" directory.

Files are uploaded using the "put" command, downloaded via "get" and deleted with "delete".

## CAUTION

Deletion of files can cause the motor controller to go into a non-functional state.

### Access to the object directory

The following URIs enable access to the object directory:

#### <IP address>/od/xxxx/yy

Requests the entry xxxx subindex yy from the object directory.

#### <IP address>/od/xxxx/data

Requests the entry xxxx with all subindices.

## 5.4.5 Information on problems

### Troubleshooting notes

If problems occur when accessing the web interface, it may be helpful to check the following points:

Problem	Solution
Green LED on the Ethernet socket does not light up	<ul style="list-style-type: none"> <li>• Replace the Ethernet cable</li> <li>• Replace the switch</li> </ul>
The web interface cannot be started via NanoFlash	<ul style="list-style-type: none"> <li>• Check the specified MAC address</li> <li>• Check the selected network card and establish a direct connection.</li> <li>• Replace the switch</li> </ul>
The motor controller does not appear in the network environment	<ul style="list-style-type: none"> <li>• Start the web interface with NanoFlash</li> <li>• Check if UPnP is activated (see UPnP-HowTo)</li> </ul>
No access to the motor controller with NanoFlash, NanoFlash outputs an error	<ul style="list-style-type: none"> <li>• Deactivate the Windows firewall</li> <li>• Deactivate the antivirus tool kits</li> <li>• Execute NanoFlash as an administrator</li> </ul>
The web interface is not correctly displayed.	<ul style="list-style-type: none"> <li>• Activate JavaScript in the browser</li> </ul>
The motor controller is sporadically unavailable via	<ul style="list-style-type: none"> <li>• Check whether the set IP address has been assigned multiple times in the network</li> </ul>

<b>Problem</b>	<b>Solution</b>
the TCP/IP; PING no longer functions Although NanoFlash can communicate with the motor controller, the browser shows no content or the "Timeout message" after "Start NanoIP" is clicked	<ul style="list-style-type: none"><li>• Use another temporary IP address</li></ul>

---

## 6 Setup and commissioning

### 6.1 Safety instructions

#### **WARNING**

In residential areas, this product may cause high-frequency interference and may require interference suppression measures.

#### **CAUTION**

##### **Alternating electromagnetic fields!**

Alternating electromagnetic fields around current-carrying cables, especially around the supply and motor cables, can cause interference in the motor and other devices.

- A charging capacitor with 10000  $\mu\text{F}$  and the necessary electric strength must be installed in the DC supply cable as close to the device as possible.
- An EMI filter (Würth Elektronik 74271112S or comparable) must be installed via the DC supply cable as close to the device as possible.
- An EMI filter (Würth Elektronik 74271222S or comparable) must be installed via the motor lines as close to the device as possible.
- Shield the cables. Run the shield connection on one side or both sides to a short earth.
- Use twisted pair cables.
- Keep power supply and motor cables as short as possible.
- Ground the motor housing large-area to a short earth.
- Run supply, motor and control cables separately.

### 6.2 Preparation

The following components are required for setup and installation:

- N5 motor controller
- Voltage supply in accordance with the data sheet
- Motor
- Lines for motor, possibly a line for the encoder

The following is required for the CAN interface:

- CANopen master
- and/or analyzer for CAN

An Ethernet cable is needed for the "Nanolp" web interface.

The following is required for the EtherCAT interface:

- EtherCAT Master
- Connecting lines for EtherCAT

### 6.3 CANopen set up and installation

Read the "**CANopen**" section in "**Configuration**" if you have not already done so.

1. Turn the rotary switch of the motor controller in that way, that the combination is set to the value "1" (see the "**CANopen**" section). This sets the NodeID to "1" and the baud rate to 1 MBd.
2. Connect the CANopen Master or a comparable CAN device to the connector of X8 (see the "**CANopen Bus IN (connector X8)**" section)

3. Configure the CANopen master or comparable device to a baud rate of 1 MBd.
4. Connect the voltage supply to connector X6 of the motor controller (see the "**Motor controller voltage supply (connector X6)**" section).
5. The motor controller must transmit a CANopen bootup message.

If a node ID other than 1 to 127 is required, continue with the "**Change NodeID**" section.

If the baud rate has to be adapted, continue with the "**Change baud rate**" section.

If you wish to operate the motor controller/motor in closed loop mode, continue with the **Auto-setup mode**.

If the bootup message could not be received, please check the following points:

- Rotary switch correctly engaged a number "1".
- Termination needed – switch on the terminating resistor as described in the "**Terminating resistor**" section.
- Check the CAN HIGH/LOW cabling, check the CAN-GND connection.
- Check the CANopen master or comparable CAN device for the baud rate of 1 MBd.

### 6.3.1 Change NodeID

#### CANopen

Make sure that you have access to the motor controller over CANopen.

1. The NodeID is set by object **2009<sub>h</sub>**. Send a CANopen-SDO message with the future NodeID to the object **2009<sub>h</sub>**.
2. Save the new specification by sending the value **65766173<sub>h</sub>** (decimal **1702257011** or ASCII "SAVE") to object **1010<sub>h</sub>:02<sub>h</sub>**.
3. Turn the rotary switch
  - to "1" to "127" if the NodeID is to get this value.
  - to "128" if the NodeID is to be taken from object **2005<sub>h</sub>**.
4. Restart the motor controller by
  - either briefly disconnecting the voltage supply
  - or sending the message "RESET COMM" to the motor controller (CobID = 0, byte 0 = **82<sub>h</sub>**, byte 1 = old NodeID)

#### Note

Should there be problems with the change of nodeid, set the rotary switch in that way, that the combination makes the value "1" to "127". The baud rate now corresponds to the value of 1 MBd, and access to the object directory is again possible.

### 6.3.2 Change baud rate

Make sure that you have access to the motor controller over CANopen.

1. The baud rate is set by object **2005<sub>h</sub>**. The assignment can be read in the table in the "**Baud rate**" section. Send a CANopen-SDO message with the value of the future baud rate to object **2005<sub>h</sub>**.
2. Save the new specification by sending the value **65766173<sub>h</sub>** (decimal **1702257011** or ASCII "SAVE") to object **1010<sub>h</sub>:02<sub>h</sub>**.
3. Turn the rotary switch
  - to "0", if the baud rate is to be permanently set at 1 MBd.
  - to "128" if the baud rate is to be taken from object **2005<sub>h</sub>**.
4. Disconnect the motor controller from the voltage supply.
5. Adapt the CANopen master to the new baud rate.
6. Reconnect the voltage supply for the motor controller. This must cause the motor controller to report again with the bootup message.

### Note

Should there be problems with the change of baud rate, set the rotary switch in that way, that the combination makes the value "1" to "127". The baud rate now corresponds to the value of 1 MBd, and access to the object directory is again possible.

## 6.4 Ethernet

Read the "**Ethernet interface**" section in "**Configuration**" if you have not already done so. Make sure that you have access to the motor controller over NanoIP.

The motor controller has the `canopen.on` file available, which contains the basic settings for CANopen. This file is loaded after the motor controller is switched on. The file is located in the directory `/FS/CONFIG/STARTUP/`

The file is in "JavaScript Object Notation" (JSON). Each row describes an object and always has the same structure.

```
"INDEX": { "SUBINDEX": "VALUE", "SUBINDEX": "VALUE" [ . . . ] },
```

All numbers are hexadecimal, where the leading `0x` is not notated, although all leading zeros are. Each value is surrounded by quotation marks; thus, for example, the index `1800h` is notated as `"1800"`. The subindex must always be notated; in the event of a variable – such as `6040h` – the value must be written to the subindex 0.

The subindices are always written in pairs with `"SUBINDEX": "VALUE"`. The value must be filled with leading zeros until the length matches that of the data type.

### Example

- The object `1800h:02h` (Unsigned08) and `03h` (Unsigned16) of the type is notated as follows: `"1800": { "02": "00", "03": "0000" },`
- The object `6040h:00h` of the type Unsigned16 is fully notated as follows: `"6040": { "00": "0006" },`

To change the NodeID, proceed as follows:

1. Download the file CANOPEN.ON from the motor controller.
  - a. On a PC, open the website of the motor controller.
  - b. Change to the "Files" tab.
  - c. In "Directories and Files", navigate to the directory "FS/CONFIG/STARTUP" and select the "CANOPEN.ON" file.
  - d. Click on the "Download" button.
    - If the file is opened in a new tab, click on the text of the homepage with the right mouse key, select the item "Save page as" and enter the target directory on the PC.
    - If the "Save as" dialog opens, enter the target location on the PS.
2. Open the file with a text editor.
  - To change the baud rate, search for the row with the entry `"2005": { "00": "87" }` and change the value as described in **2005<sub>h</sub>**.
  - To change the NodeID, search for the line with the entry `"2009": { "00": "01" }` and change the value to the desired NodeID.
3. Save your changes in the CANOPEN.ON file.
4. Load the file back onto the motor controller.
  - a. On a PC, open the website of the motor controller.
  - b. Change to the "Files" tab.
  - c. In "Directories and Files", navigate to the directory "FS/CONFIG/STARTUP" and click on the "Search" button.

- d.** Select the modified file CANOPEN.ON on your PC.
- e.** Click on the "Upload" button
- f.** Do not make any more entries until the file upload is completed.

## 7 General concepts

### 7.1 DS402 Power State machine

#### 7.1.1 State machine

##### CANopen DS402

To switch the motor controller to an operational state, a state machine must be run through. This is defined in CANopen standard DS402. State changes are requested in object **6040<sub>h</sub>** (control word). The actual state of the state machine can be read out from object **6041<sub>h</sub>** (status word).

##### Control word

State changes are requested via object **6040<sub>h</sub>** (control word). The following **table** lists the bit combinations that lead to the corresponding state transitions.

##### State transitions

The diagram shows the possible state transitions.

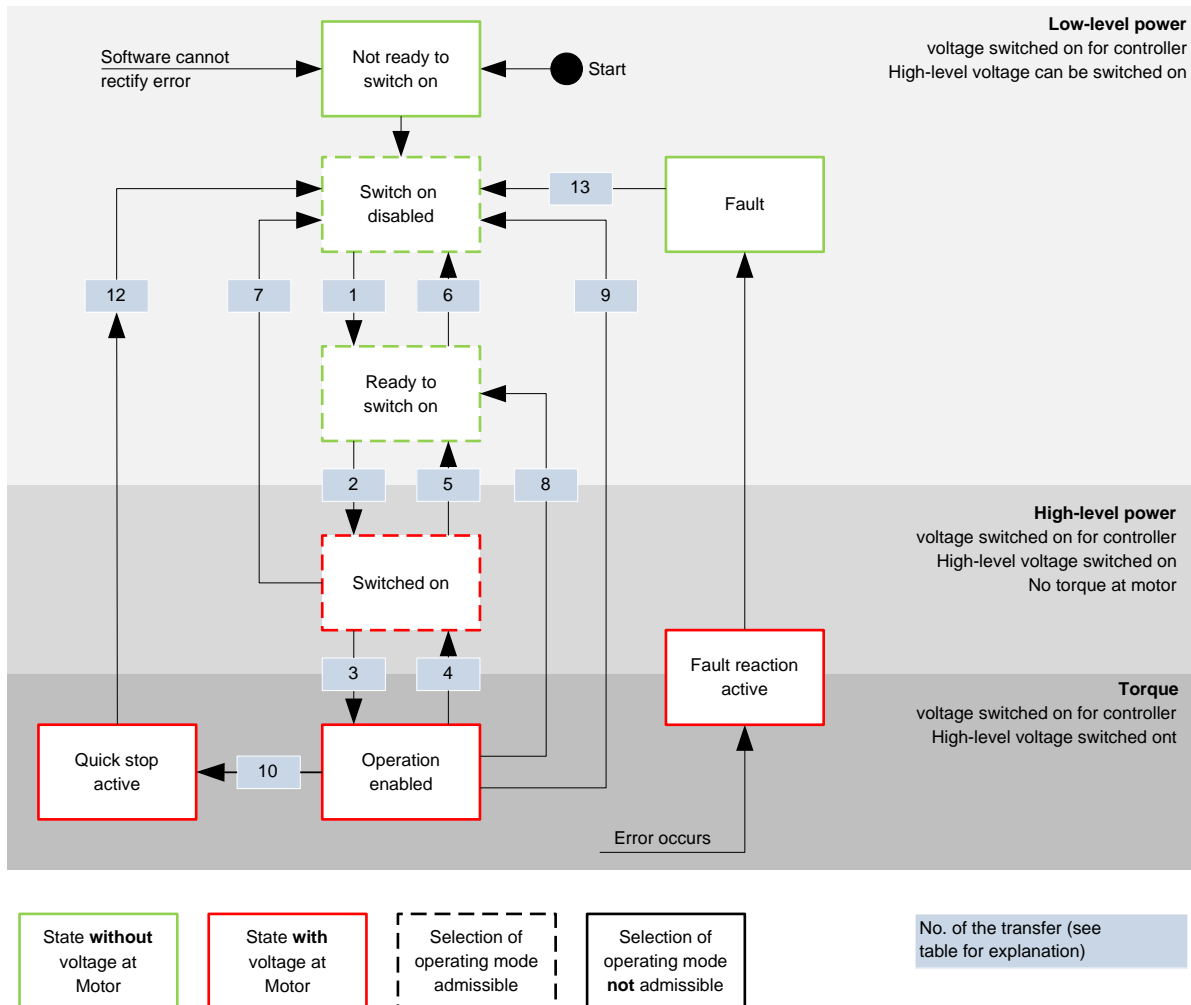

The following **table** lists the bit combinations for the control word that lead to the corresponding state transitions. An X corresponds to a bit state that is no longer to be considered. The single exception is the fault reset: The transition is only requested by the rising flank of the bit.



Command	Bit in object 6040 <sub>h</sub>					Transition
	Bit 7	Bit 3	Bit 2	Bit 1	Bit 0	
Shutdown	0	X	1	1	0	1, 5, 8
Switch on	0	0	1	1	1	2
Disable voltage	0	X	X	0	X	6, 7, 9, 12
Quick stop	0	X	0	1	X	10
Disable operation	0	0	1	1	1	4
Enable operation	0	1	1	1	1	3
Fault reset		X	X	X	X	13

### Holding torque in state "Switched On"

In the state "Switched On" no holding torque is build up by default. If a holding torque is necessary, the value "1" needs to be written in the object 3212<sub>h</sub>:01<sub>h</sub>.

## VORSICHT

If the option "Holding torque in state Switched on" is enabled, it is possible that the motor gives a start when switching the operating modes.

### Status word

The following table lists the bit masks that describe the state of the motor controller.

Status word (6041 <sub>h</sub> )	State
xxxx xxxx x0xx 0000	Not ready to switch on
xxxx xxxx x1xx 0000	Switch on disabled
xxxx xxxx x01x 0001	Ready to switch on
xxxx xxxx x01x 0011	Switched on
xxxx xxxx x01x 0111	Operation enabled
xxxx xxxx x00x 0111	Quick stop active
xxxx xxxx x0xx 1111	Fault reaction active
xxxx xxxx x0xx 1000	Fault

The motor controller reaches the "Switch on" state after it is switched on and the self-test is successful.

### Operating mode

The set operating mode (6060<sub>h</sub>) becomes active in the "Operation enabled" state. The operating mode can only be set or changed in the following states (see states enclosed by a dashed line in the diagram):

- Switch on disabled
- Ready to switch on
- Switched on

During operation ("Operation enabled"), it is not possible to change the operating mode. The "Fault" state is left when bit 7 in object 6040<sub>h</sub> (control word) is set from "0" to "1" (rising flank).

**Note:** If an error that cannot be corrected occurs, the motor controller changes to the "Not ready to switch on" state and stays there. These errors include:

- Encoder error (e.g. due to missing shielding, cable breakage)

This state can also be reached through a bus error with the EtherCAT field bus type. In this case, the system automatically changes back to the "Switch on disabled" state after the bus error is eliminated.

### 7.1.2 Behavior after the "Operation enabled" state is left

#### Brake reactions

Different brake reactions can be programmed when leaving the "Operation enabled" state.

These include the transitions described below.

The following diagram shows an overview of the brake reactions.

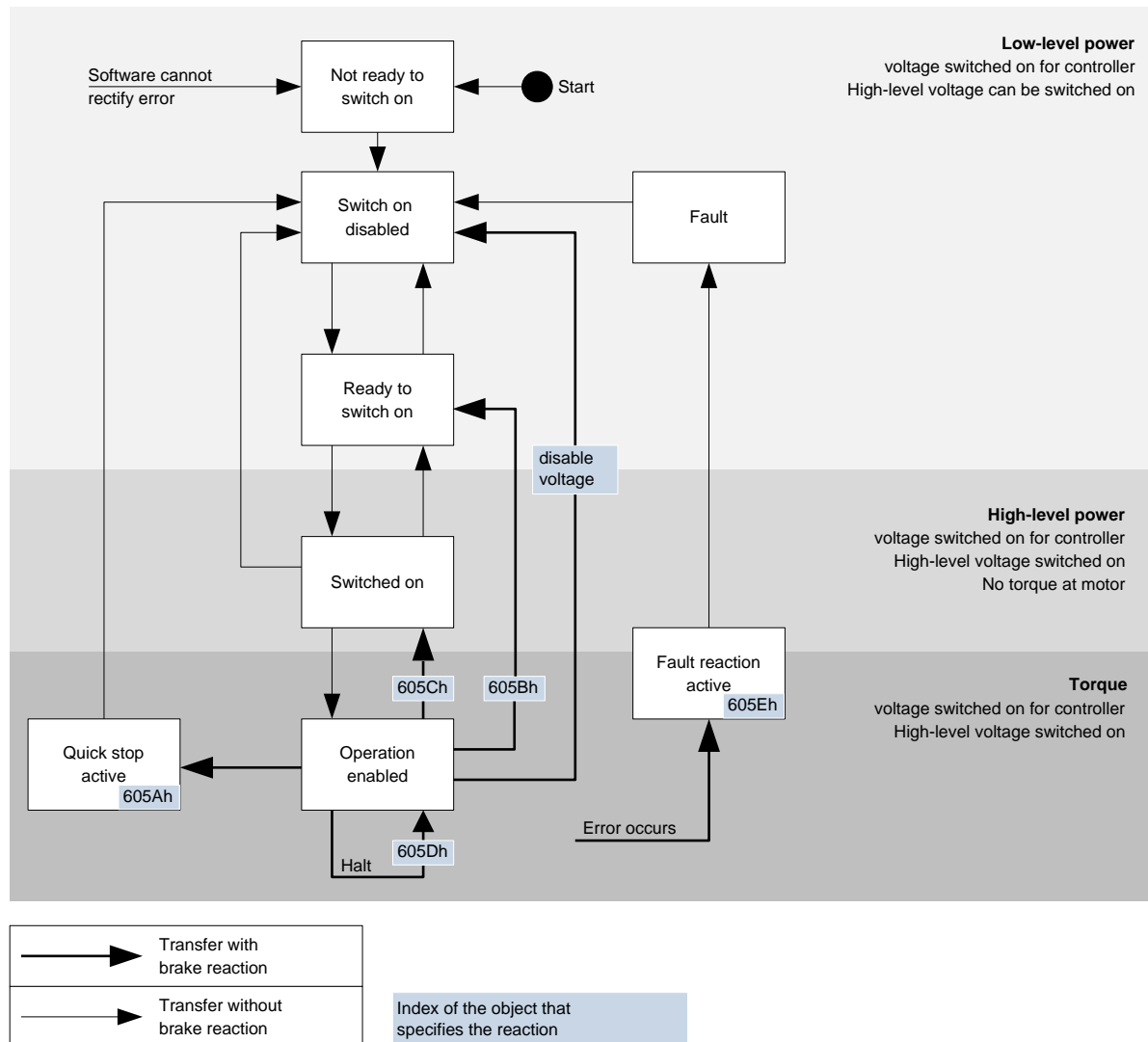

#### Quick stop active

Transition to the "Quick stop active" state (quick stop option):

In this case, the action stored in object **605A<sub>n</sub>** is executed (see the following table).

Value in object 605A <sub>n</sub>	Description
-32768 to -1	Reserved
0	Immediate stop with short-circuit braking
1	Braking with "slow down ramp" (deceleration depending on operating mode) and subsequent state change to "Switch on disabled"

Value in object 605A <sub>h</sub>	Description
2	Braking with "quick stop ramp" and subsequent state change to "Switch on disabled"
3 to 32767	Reserved

### Ready to switch on

Transition to the "Ready to switch on" state (shutdown option):

In this case, the action stored in object 605B<sub>h</sub> is executed (see the following table).

Value in object 605B <sub>h</sub>	Description
-32768 to -1	Reserved
0	Immediate stop with short-circuit braking
1	Braking with "slow down ramp" (deceleration depending on operating mode) and subsequent state change to "Switch on disabled"
2 to 32767	Reserved

### Switched on

Transition to the "Switched on" state (disable operation option):

In this case, the action stored in object 605C<sub>h</sub> is executed (see the following table).

Value in object 605C <sub>h</sub>	Description
-32768 to -1	Reserved
0	Immediate stop with short-circuit braking
1	Braking with "slow down ramp" (deceleration depending on operating mode) and subsequent state change to "Switch on disabled"
2 to 32767	Reserved

### Stop

Stop:

When bit 8 is set in object 6040<sub>h</sub> (control word), the response stored in 605D<sub>h</sub> is executed in velocity mode and profile velocity mode (see the following table).

Value in object 605D <sub>h</sub>	Description
-32768 to 0	Reserved
1	Braking with "slow down ramp" (deceleration depending on operating mode)
2	Braking with "quick stop ramp" (deceleration depending on operating mode)
3 to 32767	Reserved

### Fault

Fault:

If an error should occur, the motor is braked as stored in object 605E<sub>h</sub>.

Value in object 605E <sub>h</sub>	Description
-32768 to -1	Reserved
0	Immediate stop with short-circuit braking

Value in object 605E <sub>h</sub>	Description
1	Braking with "slow down ramp" (deceleration depending on operating mode)
2	Braking with "quick stop ramp" (deceleration depending on operating mode)
3 to 32767	Reserved

## 7.2 User-defined units

### 7.2.1 Overview

#### Settings

The motor controller supports the possibility of setting user-defined units. In this way, the corresponding parameters can be set and read out directly in degrees, mm, etc.

#### Pole pair count compensation

Differences in the pole pair counts of motors can be compensated. For this purpose, the value in object 2060<sub>h</sub> must be set to "1". Then the pole pair count automatically enters the subsequent computation so that different motors can be operated on the motor controller without requiring a new configuration.

### 7.2.2 Computation formulas for user units

#### Gear ratio

The gear ratio is calculated from the motor revolutions (6091<sub>h</sub>:1<sub>h</sub> (Motor Revolutions)) per shaft revolution (6091<sub>h</sub>:2<sub>h</sub> (Shaft Revolutions)) as follows:

$$\text{Gear ratio} = \frac{\text{Motor revolution (6091}_{h:1})}{\text{Shaft revolution (6091}_{h:2})}$$

If object 6091<sub>h</sub>:1<sub>h</sub> or object 6091<sub>h</sub>:2<sub>h</sub> are set to "0", the firmware sets the value to "1".

#### Feed constant

The feed constant is calculated from the feed (6092<sub>h</sub>:1<sub>h</sub> (Feed Constant)) per revolution of the drive axis (6092<sub>h</sub>:2<sub>h</sub> (Shaft Revolutions)) as follows:

$$\text{Feed rate} = \frac{\text{Feed (6092}_{h:1})}{\text{Revolution of the drive axis (6092}_{h:2})}$$

This is useful to indicate the spindle pitch of a linear axis.

If object 6092<sub>h</sub>:1<sub>h</sub> or object 6092<sub>h</sub>:2<sub>h</sub> are set to "0", the firmware sets the value to "1".

#### Position

The current position in user units (6064<sub>h</sub>) is calculated as follows:

$$\text{Actual position} = \frac{\text{Internal position} \times \text{feed rate}}{\text{Encoder resolution} \times \text{gear ratio}}$$

#### Speed

The speed specifications of the following objects can likewise be specified in user units:

Object	Mode	Meaning
606B <sub>h</sub>	Profile Velocity Mode	Output value of ramp generator

Object	Mode	Meaning
<b>60FF<sub>h</sub></b>	Profile Velocity Mode	Speed specification
<b>6099<sub>h</sub></b>	Homing mode	Speed for searching the index/switch
<b>6081<sub>h</sub></b>	Profile Position Mode	Target speed
<b>6082<sub>h</sub></b>	Profile Position Mode	End speed

The internal speed in mechanical revolutions per second is multiplied by a factor for numerator (**2061<sub>h</sub>**) and denominator (**2062<sub>h</sub>**). The speed in user units is computed from

$$\text{Speed} = \frac{\text{Internal speed} \times \text{numerator factor (2061}_h)}{\text{Denominator factor (2062}_h)}$$

If object **2061<sub>h</sub>** or **2062<sub>h</sub>** is to be set to "0", the firmware sets the value to "1".

### Acceleration

The acceleration can also be output in user units:

Object	Mode	Meaning
<b>609A<sub>h</sub></b>	Homing mode	Acceleration
<b>6083<sub>h</sub></b>	Profile Position Mode	Acceleration
<b>6084<sub>h</sub></b>	Profile Position Mode	Deceleration
<b>60C5<sub>h</sub></b>	Profile Velocity Mode	Acceleration
<b>60C6<sub>h</sub></b>	Profile Position Mode	Deceleration
<b>6085<sub>h</sub></b>	"Quick stop active" state ( <b>DS402 Power State machine</b> )	Deceleration

The internal acceleration in mechanical revolutions per second squared is multiplied by a factor consisting of a numerator (**2063<sub>h</sub>**) and denominator (**2064<sub>h</sub>**).

$$\text{Acceleration} = \frac{\text{Internal acceleration} \times \text{numerator factor (2063}_h)}{\text{Denominator factor (2064}_h)}$$

If object **2063<sub>h</sub>** or **2064<sub>h</sub>** is to be set to "0", the firmware sets the value to "1".

### Jerk

For the jerk, objects **60A4<sub>h</sub>:1<sub>h</sub>** to **60A4<sub>h</sub>:4<sub>h</sub>** can be specified in user units. These objects only affect the Profile Position Mode and Profile Velocity Mode.

The objects **2065<sub>h</sub>** for the numerator and **2066<sub>h</sub>** for the denominator are available. The values of objects **604A<sub>h</sub>:1<sub>h</sub>** to **4<sub>h</sub>** are computed from the mechanical revolutions per second to the power of three multiplied by a numerator and denominator:

$$\text{Jerk} = \frac{\text{Internal value} \times \text{numerator factor (2065}_h)}{\text{Denominator factor (2066}_h)}$$

If object **2065<sub>h</sub>** or **2066<sub>h</sub>** is to be set to "0", the firmware sets the value to "1".

### Positional data

All positional values in the open loop and closed loop mode are specified in the resolution of the virtual position encoder. This is calculated from the encoder cycles (**608F<sub>h</sub>:1<sub>h</sub>** (Encoder Increments)) per motor revolutions (**608F<sub>h</sub>:2<sub>h</sub>** (Motor Revolutions)) multiplied by the polarity of the axis in object **607E<sub>h</sub>** bit 0. If bit 0 in object **607E<sub>h</sub>** is set to the value "1", this corresponds to a polarity reversal, or the value "-1" in the formula:

Resolution of the position encoder = polarity (607E<sub>h</sub> Bit 0) x  $\frac{\text{Encoder cycles (608F}_h\text{:1)}}{\text{Motor revolutions (608F}_h\text{:2)}}$

If the value of **608F<sub>h</sub>:1<sub>h</sub>** or **608F<sub>h</sub>:2<sub>h</sub>** are set to "0", the motor controller continues computing internally with a "1". The factory settings are:

- Encoder increments **608F<sub>h</sub>:1<sub>h</sub>** = "2000"
- Motor revolutions **608F<sub>h</sub>:2<sub>h</sub>** = "1"
- Polarity **607E<sub>h</sub>** bit 0 = "0" (does not correspond to a polarity reversal)

The resolution of the connected position encoder is set in object **2052<sub>h</sub>**.

## 8 Operating modes

### 8.1 Profile Position

#### 8.1.1 Overview

##### Description

The Profile Position Mode is used to move to positions relative to the last target position or to the absolute last reference position. During the movement, the limit values for the speed, acceleration and deceleration and jerks are taken into account.

##### Activation

To activate the mode, the value "1" must be set in object **6060<sub>h</sub>** (Modes Of Operation) (see "**DS402 Power State machine**").

##### Control word

The following bits in object **6040<sub>h</sub>** (control word) have a special function:

- Bit 4 starts a travel order. This is carried out on a transition of "0" to "1".
- Bit 5: If this bit is set to "1", a travel order triggered by bit 4 is immediately carried out. If it is set to "0", the travel order just being carried out is completed and only then is the next travel order started.
- Bit 6: If "0", the target position (**607A<sub>h</sub>**) is absolute and if "1", the target position is relative to the actual position. The reference position is depending on the Bits 0 and 1 of the object **60F2<sub>h</sub>**.
- Bit 8 (Halt): At the transition from "1" to "0" the motor accelerates with the given start ramp to the target velocity. At the transition from "0" to "1" the motor decelerates and will come to a halt. The deceleration is depending on the settings in the "Halt Option Code" in object **605D<sub>h</sub>**.
- Bit 9: If this bit is set, the speed is not changed until the first target position is changed. This means that braking is not performed before the first destination is reached as the motor should not stop at this position.

Controlword 6040 <sub>h</sub>		
Bit 9	Bit 5	Definition
X	1	The new target position is moved to immediately.
0	0	The positioning is not completed until the next target position is being moved to with the new limitations.
1	0	The current speed is held until the current target position is reached, and only then is the new target position moved to with the new values.

Controlword 6040 <sub>h</sub>		
Bit 9	Bit 5	Definition
X	1	The new target position is moved to immediately.
0	0	The positioning is not completed until the next target position is being moved to with the new limitations.
1	0	The current speed is held until the current target position is reached, and only then is the new target position moved to with the new values.

See the figure in "**Setting move commands**".

##### Status word

The following bits in object **6041<sub>h</sub>** (status word) have a special function:

- Bit 10: Target reached: This bit is set to "1" when the last target was reached and the motor is idling for a specified time (**6068<sub>h</sub>**) within a tolerance window (**6067<sub>h</sub>**).
- Bit 12 (set-point acknowledge): This bit confirms the receipt of a new and valid time. It is synchronously set and reset with the "New set-point" bit in the control word.

An exception is if a new travel is started when another travel has not yet been completed and the next travel should only be carried out after the end of the first travel. In this case, the bit is only reset when the command has been accepted and the motor controller is ready to carry out new move commands. If a new travel order is sent although this bit is still set, the latest travel order is ignored.

The bit is not set if one of the following conditions occurs:

- The new target position can no longer be reached if the marginal conditions are adhered to.
- A target position has already been moved to and a target position has already been specified. A new target position cannot be specified until the current positioning has been completed.
- The new position is outside of the valid range (**607D<sub>h</sub>** (Software Position Limit)).
- Bit 13 (Following Error): This bit is set in closed loop mode if the following error is greater than the set limits is (**6065<sub>h</sub>** (Following Error Window) and **6066<sub>h</sub>** (Following Error Time Out)).

### 8.1.2 Setting move commands

#### Move command

In object **607A<sub>h</sub>** (Target Position), the new target position is specified in user units (see "User-defined units"). Afterwards, the move command is triggered when bit 4 is set in object **6040<sub>h</sub>** (control word). If the target position is valid, the motor controller responds with bit 12 in object **6041<sub>h</sub>** (status word) and begins the positioning run. As soon as the position is reached, bit 10 is set to "1" in the status word.

#### Profile of the move command

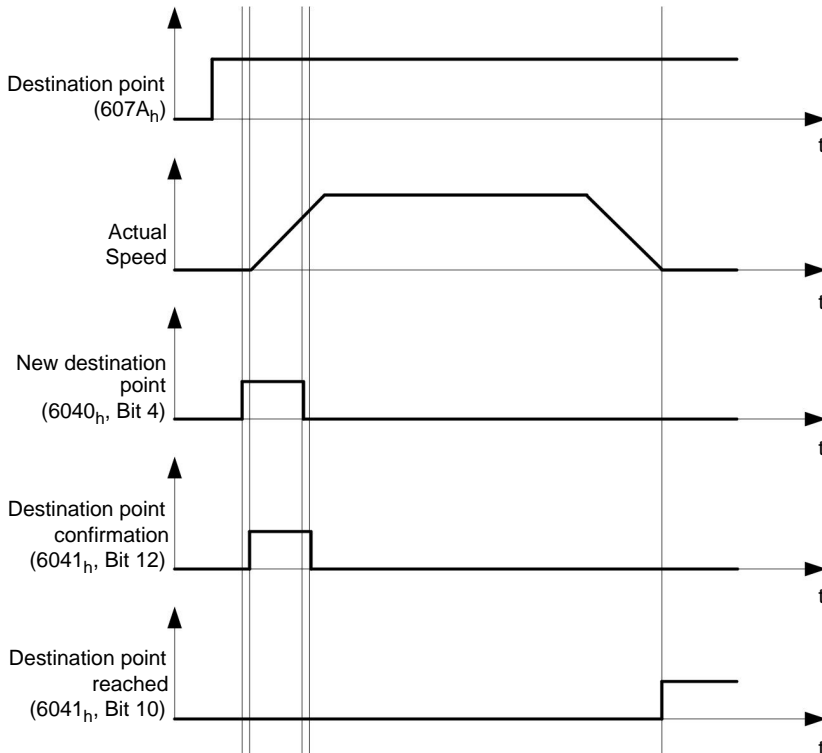

#### Further move commands

Bit 12 in object **6041<sub>h</sub>** (status word, set-point acknowledge) changes to "0" if another move command can be buffered (see time 1 in the following diagram). While a target position is being moved to, a second target position can be transferred to the motor controller in preparation. All parameters – such as speed, acceleration, deceleration, etc. – can be reset (time 2). After the buffer is empty again, the next time can be added to the sequence (time 3).



If the buffer is already full, a new time is ignored (time 4). If bit 5 in object **6040<sub>h</sub>** (control word, bit: "Change Set-Point Immediately") is set, the motor controller operates without the buffer and new move commands are implemented directly (time 5).

**Times**

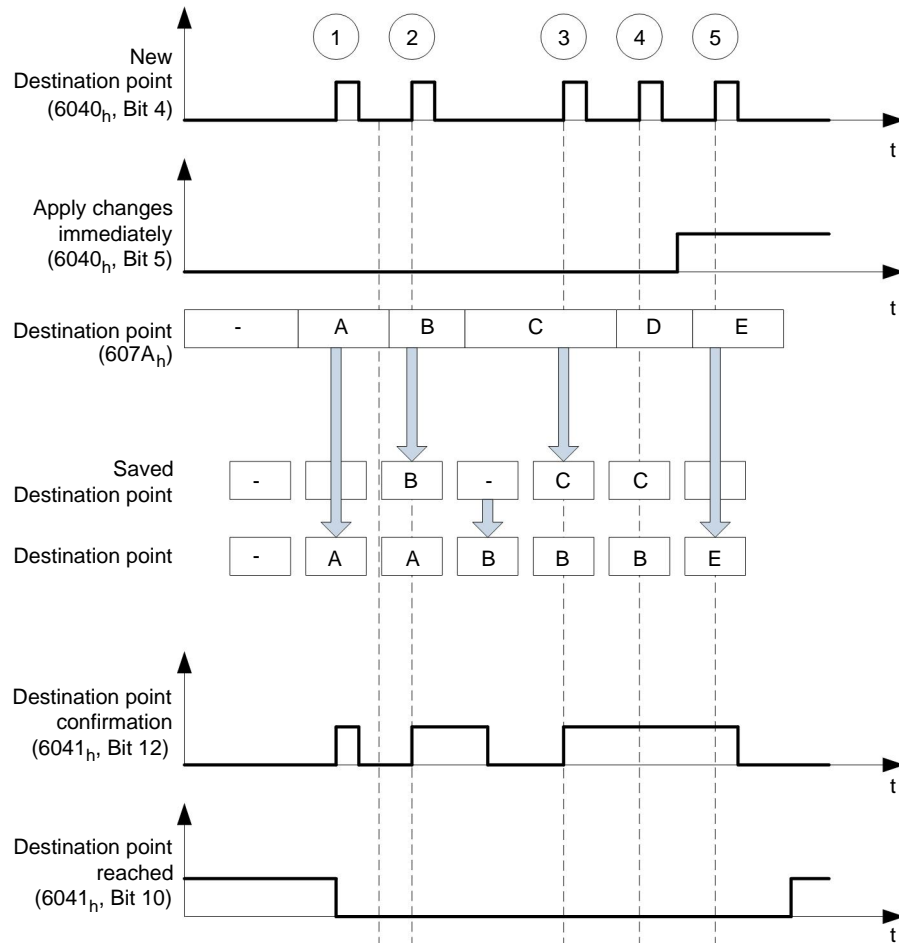

**Transition procedure for second target position**

The following graphic shows the transition procedure for the second target position while the first target position is being moved to. In this figure, bit 5 of object **6040<sub>h</sub>** (control word) is set to "1" and the new target value is adopted immediately.

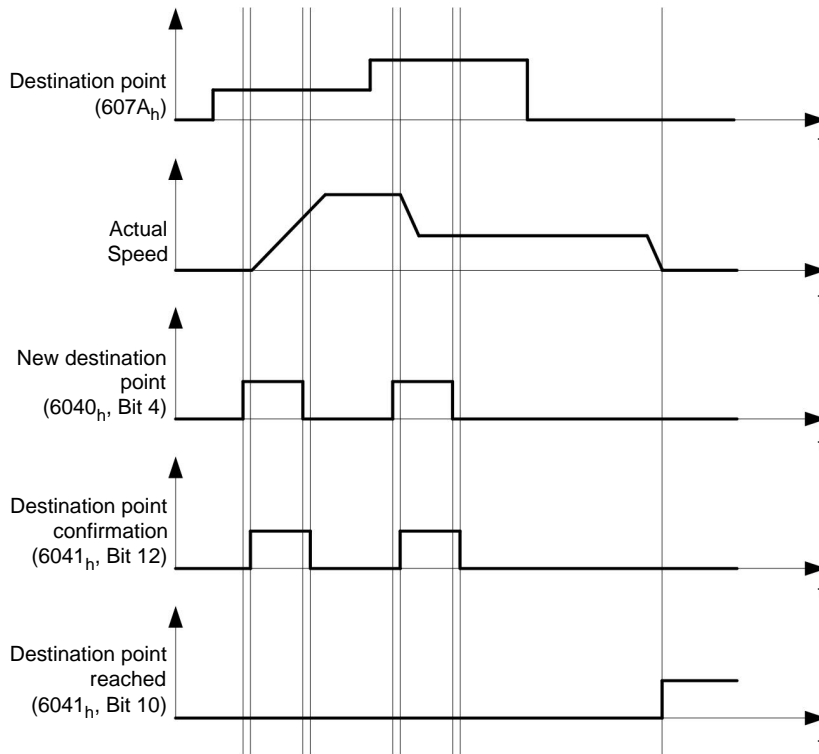

### Options for moving to a target position

If bit 9 in object **6040<sub>h</sub>** (control word) is "0", the actual target position is first moved to completely. In this example, the end speed (**6082<sub>h</sub>**) of the first target position is zero. If bit 9 is set to "1", the end speed is held until the target position is reached; only then do the new marginal conditions apply.

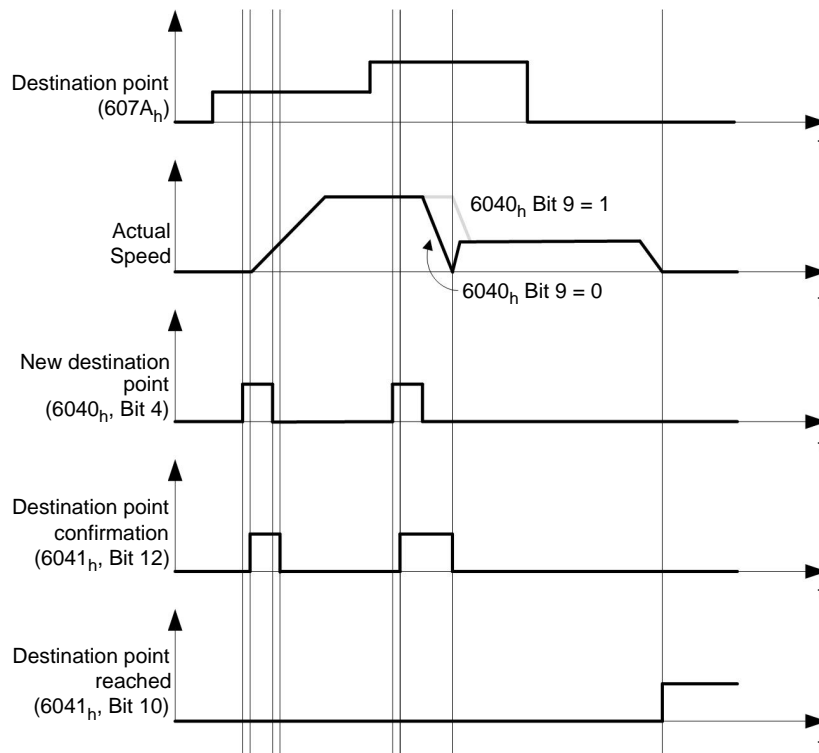

### 8.1.3 Marginal conditions for a positioning run

#### Object entries

The marginal conditions for the position to which the run is made can be set in the following entries of the object directory:

- **6064<sub>h</sub>** (Position Actual Value): Actual position of the motor
- **607A<sub>h</sub>** (Target Position): Planned target position
- **607B<sub>h</sub>** (Position Range Limit): Definition of the limit stops (see the section below)
- **607C<sub>h</sub>** (Home Offset): Shifting of the machine zero point (see "Homing")
- 
- **607E<sub>h</sub>** (Polarity): Direction of rotation
- **6081<sub>h</sub>** (Profile Velocity): Maximum speed with which the position should be moved to
- **6082<sub>h</sub>** (End Velocity): Speed when reaching the target position
- **6083<sub>h</sub>** (Profile Acceleration): Required acceleration
- **6084<sub>h</sub>** (Profile deceleration): Required deceleration
- **6085<sub>h</sub>** (Quick Stop Deceleration): Emergency stop deceleration in case of the "Quick stop active" state of the "DS402 Power State machine"
- **6086<sub>h</sub>** (Motion Profile Type): Type of ramp to be moved to; if the value is "0", jerk is not limited, if value is "3", the values from 60A4<sub>h</sub>:1<sub>h</sub> - 4<sub>h</sub> are set as jerk limitations.
- **60C5<sub>h</sub>** (Max Acceleration): The maximum acceleration that may not be exceeded when moving to the end position.
- **60C6<sub>h</sub>** (Max Deceleration): The maximum deceleration that may not be exceeded when moving to the end position
- **60A4<sub>h</sub>** (Profile Jerk), subindex 01<sub>h</sub> to 04<sub>h</sub>: Objects for describing the limit values for the jerk. This value will be clipped by the "Real Jerk Limit" (see **2067<sub>h</sub>** for further information).
- **2067<sub>h</sub>** (Jerk Limit (internal)): object for the jerk limit.

### Objects for the positioning run

The following graphic shows the objects involved for the marginal conditions for the positioning run.

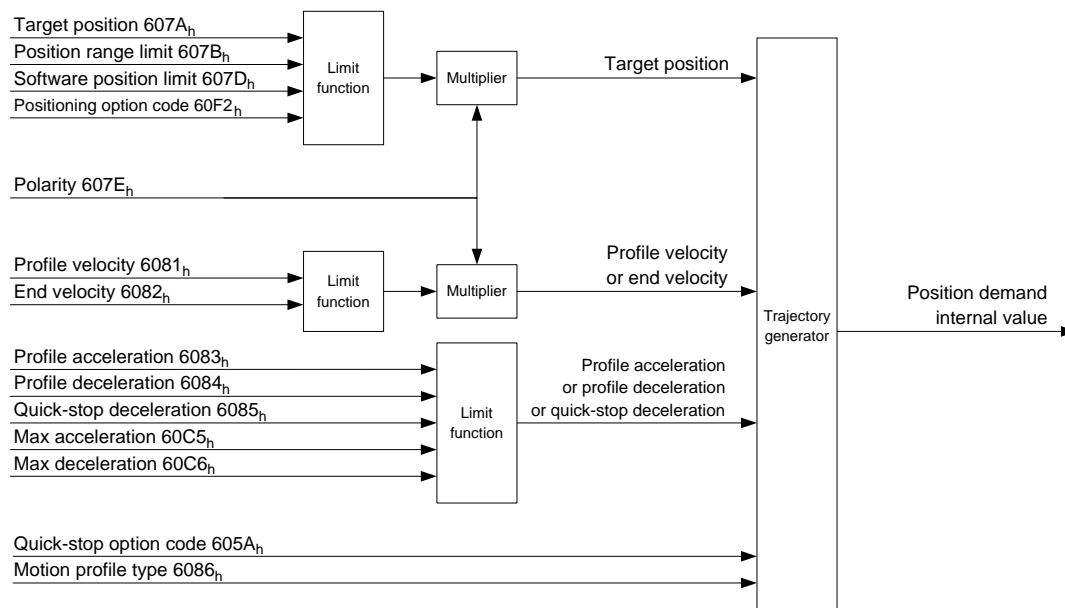

### Parameters for the target position

The following diagram shows an overview of the parameters that are used for moving to a target position (figure is not to scale).

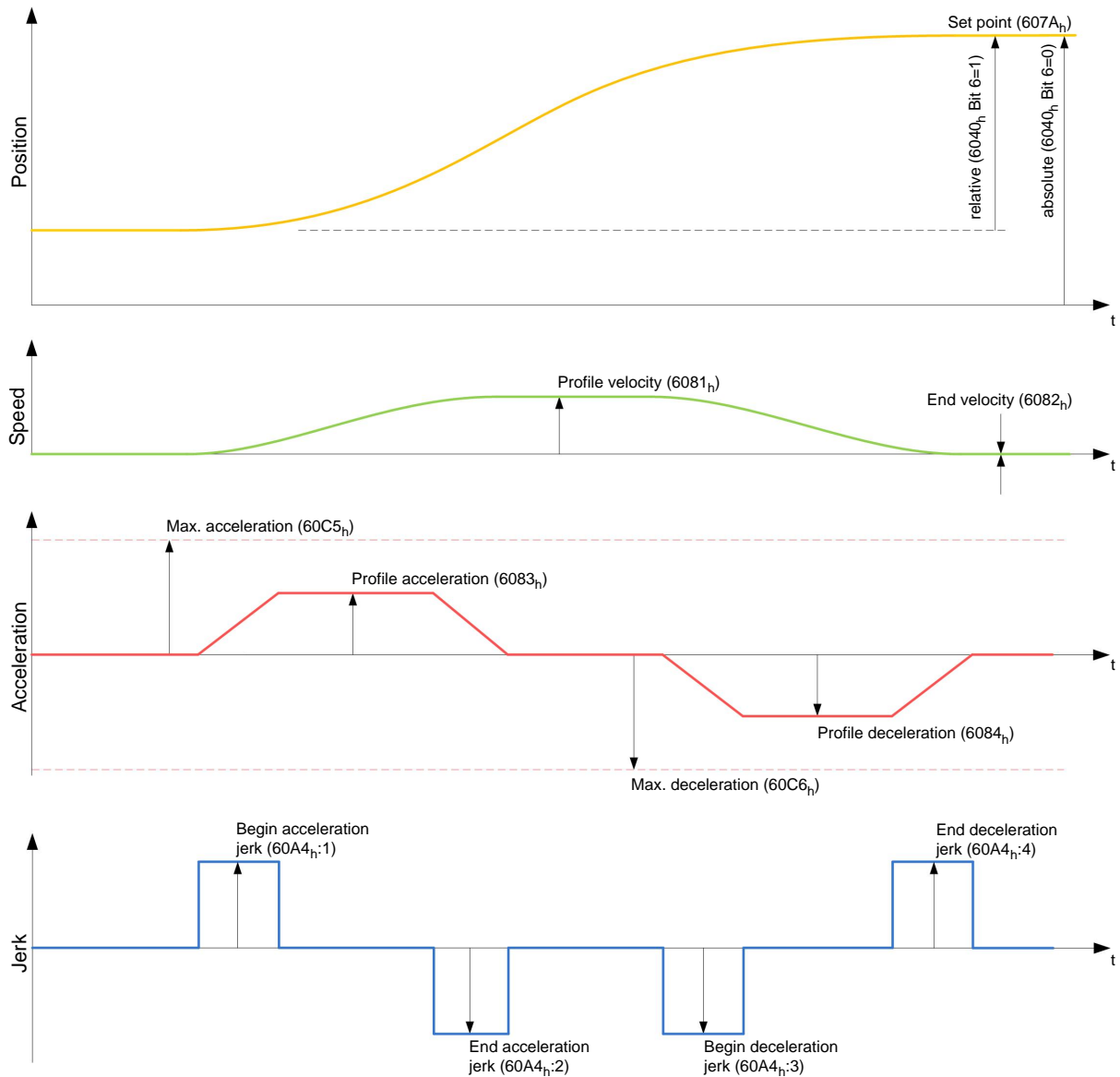

### 8.1.4 Jerk-limited and non-jerk-limited mode

#### Description

Two basic modes exist: the "jerk-limited" and "non-jerk-limited" mode.

#### Jerk-limited mode

A jerk-limited positioning is achieved by setting object **6086<sub>h</sub>** to "3". This causes the entries for the jerks in object **60A4<sub>h</sub>:01<sub>h</sub>-04<sub>h</sub>** to become valid.

#### Non-jerk-limited mode

A "0" in an entry means that there is no jerk limitation at the particular point in the profile.

If all four entries of object **60A4<sub>h</sub>** are set to "0", a non-jerk-limited ramp is traveled.

A "non-jerk-limited" ramp is traveled in two ways: either all values of the jerk in the entries **60A4<sub>h</sub>:01<sub>h</sub>** to **60A4<sub>h</sub>:04<sub>h</sub>** are set to "0" and the object **6086<sub>h</sub>** is set to "3", or the entry in the object **6086<sub>h</sub>** is set to "0".

## 8.2 Velocity

### 8.2.1 Description

This mode operates the motor with a specified target in a manner similar to a frequency converter. In contrast to profile velocity mode, this mode operates without a speed monitor and does not permit jerk-limited ramps to be selected.

### 8.2.2 Activation

To activate the mode, the value "2" must be set in object **6060<sub>h</sub>** (Modes Of Operation) (see "**DS402 Power State machine**").

### 8.2.3 Control word

The following bits in object **6040<sub>h</sub>** (control word) have a special function:

- Bit 2 is used to trigger a quick stop. If it is set to "0", the motor carries out a quick stop with the ramp set in object **604A<sub>h</sub>**. Then the motor controller changes to the "Switch on disabled" state (see **6040<sub>h</sub>**).
- Bit 8 (Stop): On a transition of "0" to "1" the motor accelerates up to the target speed with the set acceleration ramp. On a transition of "1" to "0", the motor brakes according to the brake ramp and comes to a stop.

### 8.2.4 Status word

The following bits in object **6041<sub>h</sub>** (status word) have a special function:

- Bit 11: Limit exceeded: The target speed exceeds or undercuts the entered limit values.

### 8.2.5 Object entries

The following objects are required to control this mode:

- **604C<sub>h</sub>**(Dimension Factor):

The unit for the speed specifications for the following objects are defined here. If subindices 1 and 2 are set to value "1", the speed is indicated in revolutions per minute.

Otherwise, subindex 1 contains the multiplier and subindex 2 the divisor with which the speed specifications are computed. The result is interpreted as revolutions per second; at object **2060<sub>h</sub>**, the selection is made of whether these are electrical (**2060<sub>h</sub>= 0**) or mechanical (**2060<sub>h</sub>= 1**) revolutions per second.

The target speed is set in user units here.

- **6042<sub>h</sub>**: Target Velocity
- **6048<sub>h</sub>**: Velocity Acceleration

This object defines the start acceleration. Subindex 1 contains the speed change, and subindex 2 the associated time in seconds. Both together are computed as the acceleration:

$$\text{VL velocity acceleration} = \frac{\text{Delta speed (6048}_{h};1)}{\text{Delta time (6048}_{h};2)}$$

- **6049<sub>h</sub>** (Velocity Deceleration):

This object defines the deceleration. The subindices are structured as described in object **6048<sub>h</sub>**, and the speed difference must be indicated by a positive sign.

- **6085<sub>h</sub>** (Quick Stop Deceleration):

Emergency stop deceleration in case of the "Quick stop active" state of the "DS402 Power State machine"

- **6046<sub>h</sub>** (Velocity Min Max Amount):

In this object the limitations to target speeds are specified.

The minimum speed is set in **6046<sub>h</sub>:01<sub>h</sub>**. If the target speed (**6042<sub>h</sub>**) drops below the minimum speed, the value is limited to the minimum speed **6046<sub>h</sub>:01<sub>h</sub>**.

The maximum speed is set in **6046<sub>h</sub>:02<sub>h</sub>**. If the target speed (**6042<sub>h</sub>**) exceeds the maximum speed, the value is limited to the maximum speed **6046<sub>h</sub>:02<sub>h</sub>**.

- **604A<sub>h</sub>** (Velocity Quick Stop):

The quick stop ramp can be set with this object. Subindices 1 and 2 are the same as specified for object **6048<sub>h</sub>**.

### Speeds in Velocity Mode

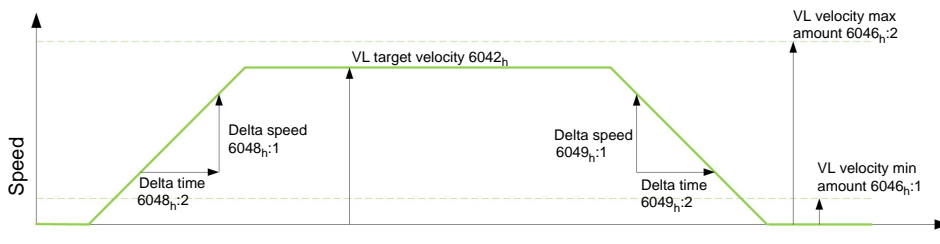

### Objects for the Velocity Mode

The ramp generator follows the target speed while adhering to the set speed and acceleration limits. Bit 11 is set in object **6041<sub>h</sub>** (internal limit active) when a limitation is active.

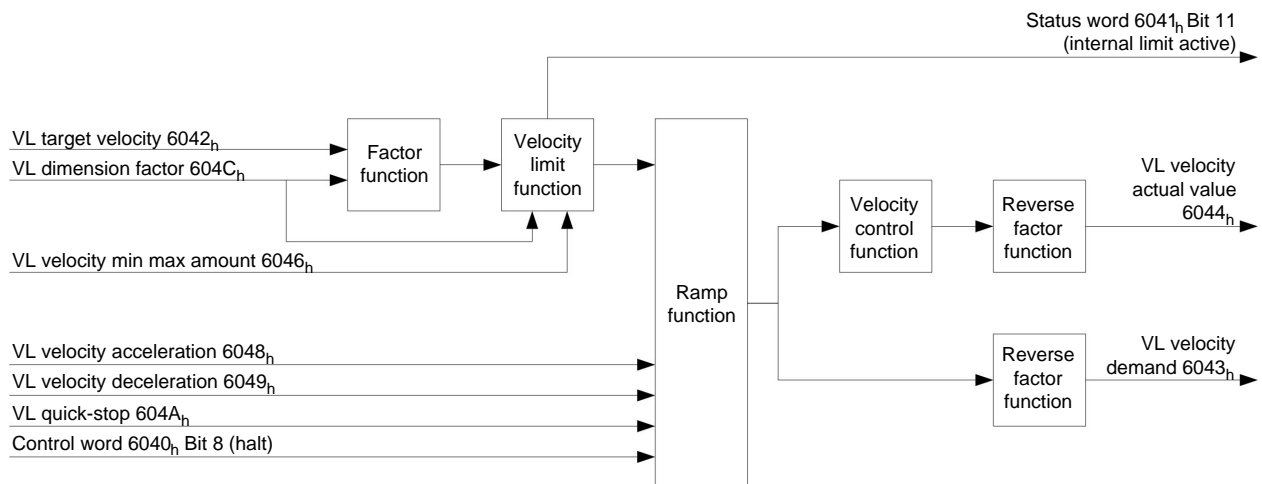

## 8.3 Profile Velocity

### 8.3.1 Description

This mode operates the motor in Velocity Mode with expanded ramps. Unlike velocity mode (see "**Velocity**"), the actual speed can be monitored via an external encoder in this mode.

### 8.3.2 Activation

To activate the mode, the value "3" must be set in object **6060<sub>h</sub>** (Modes Of Operation) (see "**DS402 Power State machine**").

### 8.3.3 Control word

The following bits in object **6040<sub>h</sub>** (control word) have a special function:

- Bit 2 is used to trigger an quick stop. If it is set to "0", the motor carries out a quick stop with the ramp set in object **6085<sub>h</sub>**. Then the motor controller changes to the "Switch on disabled" state (**6040<sub>h</sub>**).

- Bit 8 (Stop): On a transition of "0" to "1", the motor accelerates up to the target speed with the set starting ramp. On a transition of "1" to "0", the motor brakes and comes to a stop.

### 8.3.4 Status word

The following bits in object **6041<sub>h</sub>**(status word) have a special function:

- Bit 10 (target speed reached); Target Reached: This bit in combination with bit 8 in the control word indicates whether or not the target speed has been reached, the motor is braking, or the motor is idling (see table).

<b>6041<sub>h</sub></b> <b>Bit 10</b>	<b>6040<sub>h</sub></b> <b>Bit 8</b>	<b>Description</b>
0	0	Target speed attained
0	1	Axis is braking
1	0	The target speed within the target window (defined in <b>606D<sub>h</sub></b> and <b>606E<sub>h</sub></b> )
1	1	Speed of axis is 0

### 8.3.5 Object entries

The following objects are required to control this mode:

- **606B<sub>h</sub>**(Velocity Demand Value):  
This object contains the output of the ramp generator which is the specified value for the speed controller at the same time.
- **606C<sub>h</sub>**(Velocity Actual Value):  
Specifies the current actual speed.
- **606D<sub>h</sub>**(Velocity Window):  
This value specifies by how much the actual speed may vary from the set speed for bit 10 (target speed reached; Target Reached) in object **6041<sub>h</sub>**(status word) is to be set to "1".
- **606E<sub>h</sub>**(Velocity Window Time):  
This object indicates how long the actual speed and the set speed must be near each other in magnitude (see **606D<sub>h</sub>**"Velocity Window") for bit 10 "Target Reached" in object **6041<sub>h</sub>**(status word) to be set to "1".
- **607E<sub>h</sub>**(Polarity):  
If bit 6 is set to "1", the sign (plus/minus) of the target speed is reversed.
- **6083<sub>h</sub>**(Profile acceleration):  
Sets the value for the acceleration ramp in velocity mode.
- **6084<sub>h</sub>**(Profile Deceleration):  
Sets the value for the braking ramp in velocity mode.
- **6085<sub>h</sub>**(Quick Stop Deceleration):  
Sets the value for the braking ramp for the quick stop in velocity mode.
- **6086<sub>h</sub>**(Motion Profile Type):  
Here the ramp type can be selected (0 = trapezoid ramp, 3 = jerk-limited ramp).
- **604A<sub>h</sub>**(Velocity Quick Stop), subindex 01<sub>h</sub> to 04<sub>h</sub> :  
The four jerk values are specified here if a jerk-limited ramp is set.
- **60FF<sub>h</sub>**(Target Velocity):  
Specifies the target speed to be attained.
- **2031<sub>h</sub>**(Peak Current):  
Maximum current in mA

### Objects in Profile Velocity Mode

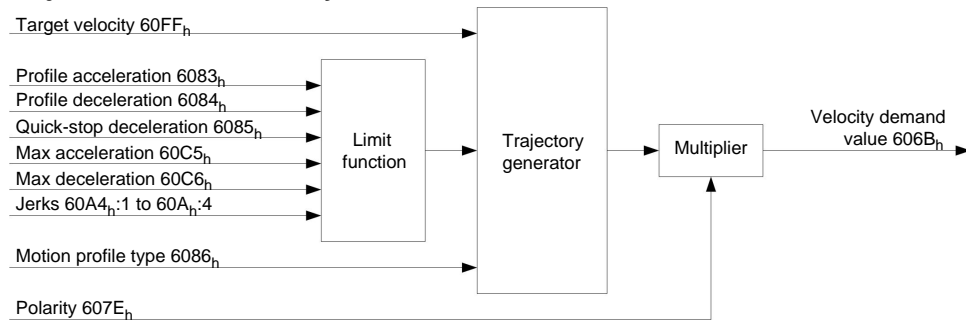

### Mode activation

After the mode was selected in object **6060<sub>h</sub>**(Modes of Operation) and the "Power State machine" (see "DS402 Power State machine") was switched to "Operation Enabled", the motor is accelerated to the target speed in **60FF<sub>h</sub>**(see the following diagrams). The speed, the acceleration and, in the case of jerk-limited ramps, the jerk limited values are taken into account.

### Limitations in the jerk-limited case

The following diagram shows the adjustable limitations in the jerk-limited case (**6086<sub>h</sub>=3**).

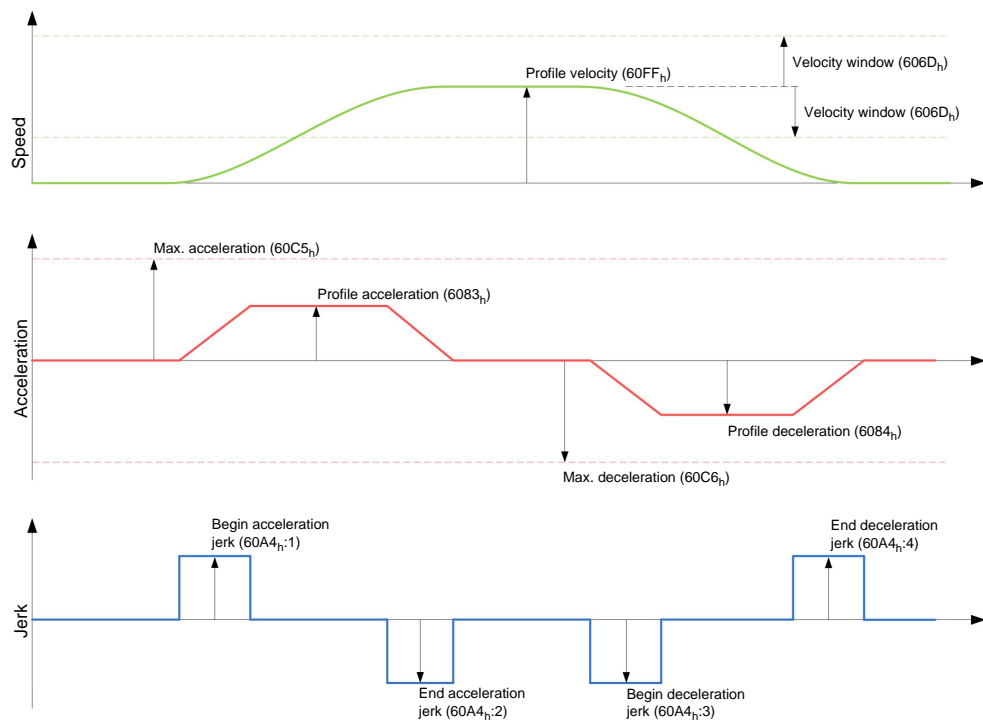

### Limitations in trapezoid case

This diagram shows the adjustable limitations for the trapezoid case (**6086<sub>h</sub>= 0**).



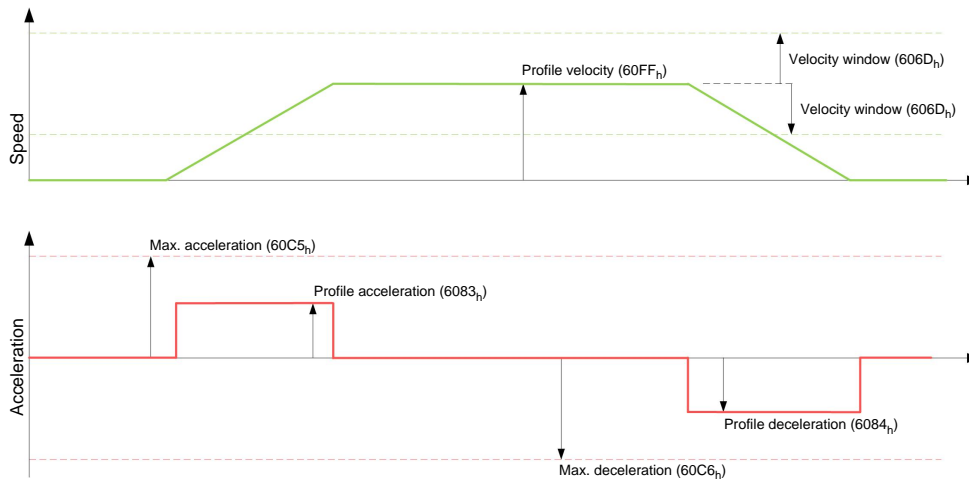

## 8.4 Profile Torque

### 8.4.1 Description

In this mode, the torque is specified as the set point and is moved to via a ramp function.

### 8.4.2 Activation

To activate the mode, the value "4" must be set in object **6060<sub>h</sub>**(Modes Of Operation) (see "**DS402 Power State machine**").

### 8.4.3 Control word

The following bits in object **6040<sub>h</sub>**(control word) have a special function:

- Bit 8 (Stop): If this bit is set to "0", the motor is started according to the specifications. When set to "1", the motor is brought to idling according to the specified values.

### 8.4.4 Status word

The following bits in object **6041<sub>h</sub>**(status word) have a special function:

- Bit 10 (Target Reached): This bit in combination with bit 8 of object **6040<sub>h</sub>**(control word) indicates whether or not the specified torque has been reached (see the following table).

<b>6040<sub>h</sub></b>	<b>6041<sub>h</sub></b>	<b>Description</b>
<b>Bit 8</b>	<b>Bit 10</b>	
0	0	Specified torque not attained
0	1	Specified torque attained
1	0	Axis accelerated
1	1	Speed of axis is 0

### 8.4.5 Object entries

All values of the following entries in the object directory must be specified as one thousandth of the maximum torque, which corresponds to the maximum current (**2031<sub>h</sub>**). This includes the following objects:

- **6071<sub>h</sub>**(Target Torque):  
Target value of the torque
- **6072<sub>h</sub>**(Max Torque):  
Maximum torque during the entire ramp (acceleration, hold torque, brake)

- **6074<sub>h</sub>**(Torque Demand):  
Current output value of the ramp generator (torque) for the control
- **6087<sub>h</sub>**(Torque Slope):  
Maximum change of the torque per second
- **3202<sub>h</sub>** Bit 5 (Motor Drive Submode Select):  
If this bit is set to "0", the drive control is operated in torque-limited velocity mode, i.e. the maximum speed can be limited in object **2032<sub>h</sub>** and the control can work in field weakening mode.  
If this bit is set to "1", the control works in torque mode, the maximum speed cannot be limited here and field weakening mode is not possible.

#### Objects of the ramp generator

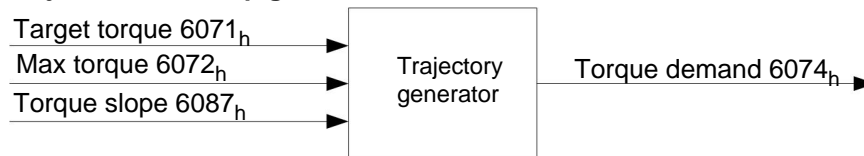

#### Torque curve

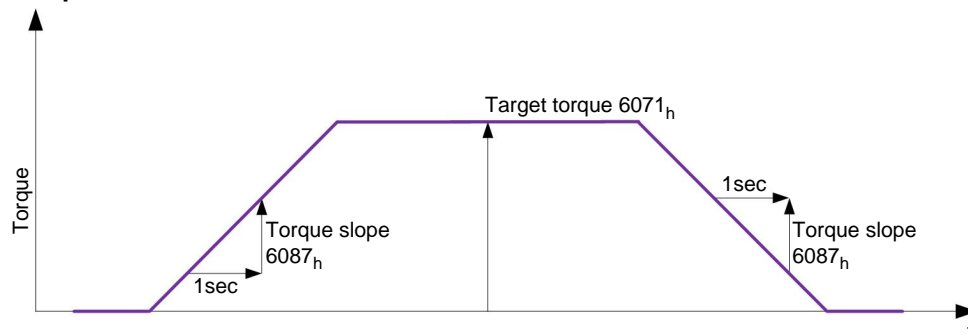

## 8.5 Homing

### 8.5.1 Overview

#### Description

The purpose of the reference run (homing method) is to synchronize the motor controller with the encoder index of the motor or position switch in a system.

#### Activation

To activate the mode, the value "6" must be set in object **6060<sub>h</sub>**(Modes Of Operation) (see "**DS402 Power State machine**").

If a reference and/or limit switch is used, these special functions first need to be activated in the I/O configuration (see "**Digital inputs and outputs**").

#### Control word

The following bits in object **6040<sub>h</sub>**(control word) have a special function:

- Bit 2 is used to trigger an quick stop. If it is set to "0", the motor carries out a quick stop with the ramp set in object **6085<sub>h</sub>**. The motor then goes into "Switch on disabled" mode (see the "**DS402 Power State machine**" section).
- Bit 4: If the bis is set to "1", the referencing is started. This is set forth until either the reference position is reached or bit 4 is set to "0" again.

## Status word

The following bits in object **6041<sub>h</sub>**(status word) have a special function:

Bit 13	Bit 12	Bit 10	Description
0	0	0	Homing procedure is in progress
0	0	1	Homing procedure is interrupted or not started
0	1	0	Homing is attained, but target is not reached
0	1	1	Homing procedure is completed successfully
1	0	0	Homing error occurred, velocity is not 0
1	0	1	Homing error occurred, velocity is 0

## Object entries

The following objects are required to control this mode:

- **607C<sub>h</sub>** (Home Offset): Specifies the difference between the zero position of the application and the reference point of the machine.
- **6098<sub>h</sub>**(Homing Method):  
Method used for referencing (see "**Reference run method**")
- **6099<sub>h</sub>:01<sub>h</sub>** (Speed During Search For Switch):  
The speed for the search for the switch
- **6099<sub>h</sub>:02<sub>h</sub>** (Speed During Search For Zero):  
The speed for the search for the index
- **609A<sub>h</sub>**(Homing Acceleration):  
Acceleration and deceleration for the reference run
- **2056<sub>h</sub>**(Limit Switch Tolerance Band):  
After moving to the positive or negative limit switch, the motor controller permits a tolerance range that the motor may not further travel. If this tolerance range is exceeded, the motor stops and the motor controller changes to the "Fault" state. If limit switches can be activated during the reference run, the tolerance range selected should be sufficiently large so that the motor does not leave the tolerance range when braking. Otherwise, the reference run cannot be completed successfully. After completion of the reference run, the tolerance range can be set back to "0" if this is required by the application.
- **203A<sub>h</sub>:01<sub>h</sub>** (Minimum Current For Block Detection):  
Minimum current threshold that, when exceeded, detects blocking of the motor at a block.
- **203A<sub>h</sub>:02<sub>h</sub>** (Period Of Blocking):  
Specifies the time in ms that the motor is nevertheless still to travel against the block after block detection.
- **203A<sub>h</sub>:03<sub>h</sub>** (Block Detection Time)  
Specifies the time in ms that the current has to be at least above the minimum current threshold in order to detect a block

## Speeds of the reference run

The figure shows the speeds of the reference run using method 4 as an example:

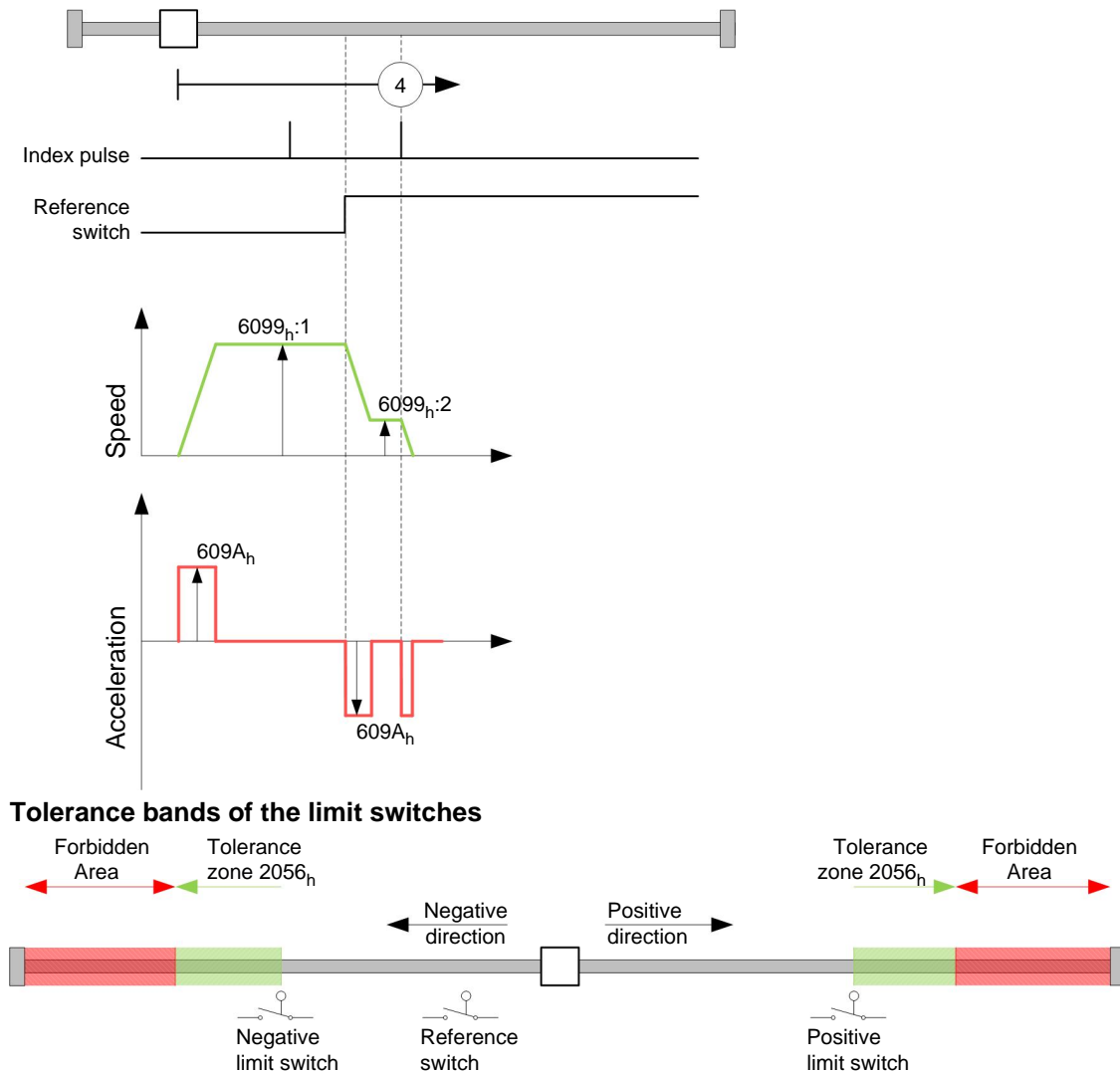

## 8.5.2 Reference run method

### Description

The reference run method is written into object **6098<sub>h</sub>** as a number and defines whether referencing should be performed on a switch flank (rising/falling), a current threshold for block detection or an index pulse is referenced, or in which direction the reference run should start. Methods that use the index pulse of the encoder are within the number range 1 to 14, 33 and 34. Methods that reference a limit switch are between 17 and 30, but their travel profiles are identical with those of the methods 1 to 14. These numbers are shown in circles in the following figures. Methods that do not use a limit switch, and instead travel against a block is to be detected, must be called up with a minus in front of the method number.

For the following diagrams, the negative movement direction is to the left. The limit switch is located in front of the mechanical block in each case, and the reference switch (home switch) is between the two limit switches. The index pulses come from the encoder, which is connected with the motor shaft and motor controller.

For methods that use homing on block, the same illustrations apply as for the methods with limit switch. New illustrations are not shown as nothing changes except for the missing limit switches. In this case, the limit switches have to be replaced by a mechanical block in the illustrations.

## Homing on block

Homing on block functions perfectly only in closed loop mode at the moment. The finer points that have to be observed for homing on block in closed loop mode, for instance, are given in detail in the section on controls.

For certain applications it is appropriate to travel against the block for a specific time after a block has been detected. This time can be set in object **203A<sub>h</sub>:02<sub>h</sub>** in ms.

To ensure very precise detection of the block, the block should be traveled against with a very low speed (**6099<sub>h</sub>:01<sub>h</sub>**), high current limit (**203A<sub>h</sub>:01<sub>h</sub>**), and high homing acceleration (**609A<sub>h</sub>**). Additionally, detection can be refined by the block detection time (**203A<sub>h</sub>:03<sub>h</sub>**).

## Methods overview

Methods 1 to 14, and 33 and 34 use the index pulse of the encoder.

Methods 17 to 32 are identical with the methods 1 to 14 with the exception that referencing is only performed on the limit or home switch and not on the index pulse.

- Methods 1 to 14 contain an index pulse
- Methods 15 and 16 do not exist
- Methods 17 to 30 do not have an index pulse
- Methods 31 and 32 do not exist
- Methods 33 and 34 reference only to the next index pulse
- Method 35 references to the actual position

The following methods can be used for homing on block:

- Methods -1 to -2 and -7 to -14 contain an index pulse
- Methods -17 to -18 and -23 to -30 do not have an index pulse

## Methods 1 and 2

Reference the limit switch and index pulse.

Method 1 references a negative limit switch and index pulse:

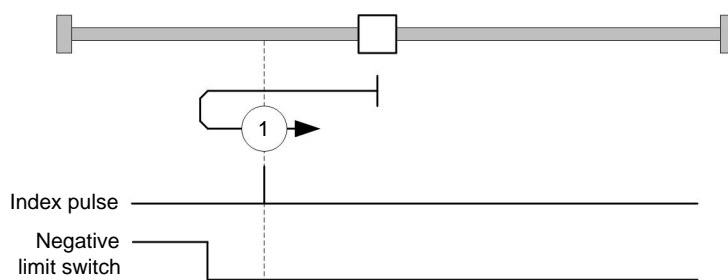

Method 2 references a positive limit switch and index pulse:

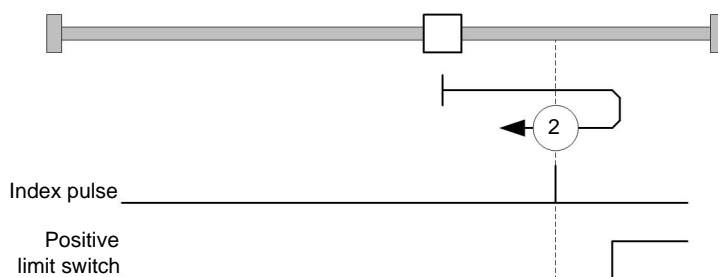

## Methods 3 to 6

These methods reference the switch flank of the reference switch and index pulse.

In the methods 3 and 4, the left switch flank of the reference switch is used as a reference:

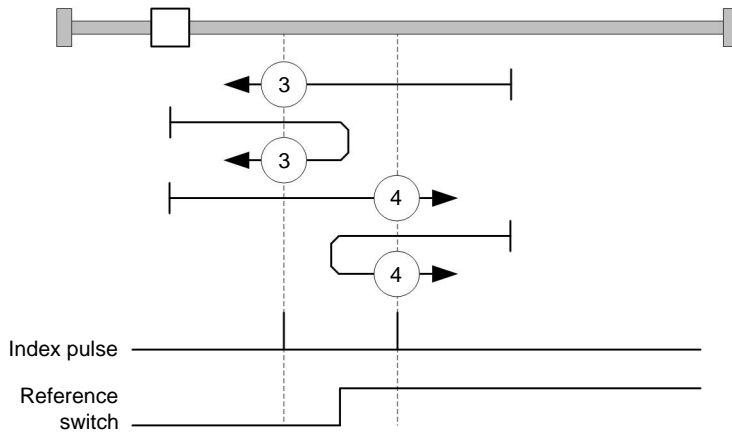

In the methods 5 and 6, the right switch flank of the reference switch is used as a reference:

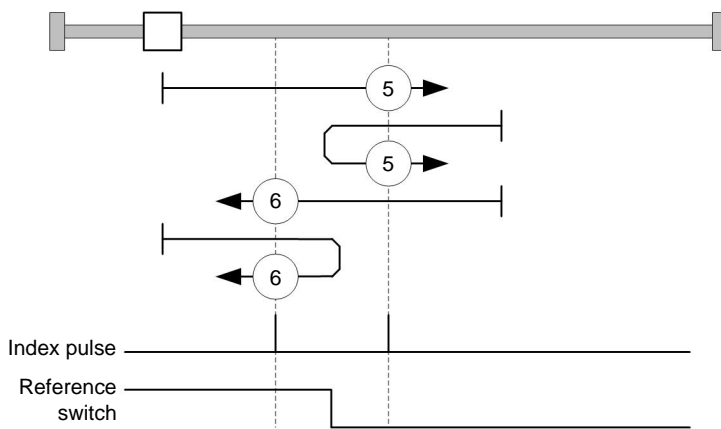

### Methods 7 to 14

These methods reference the home switch and index pulse (with limit switches).

For these methods, the actual position relative to the reference switch is unimportant. With method 10, referencing is for instance always to the index pulse on the right next to the right flank of the reference switch.

The methods 7 to 10 take the positive limit switch into account:

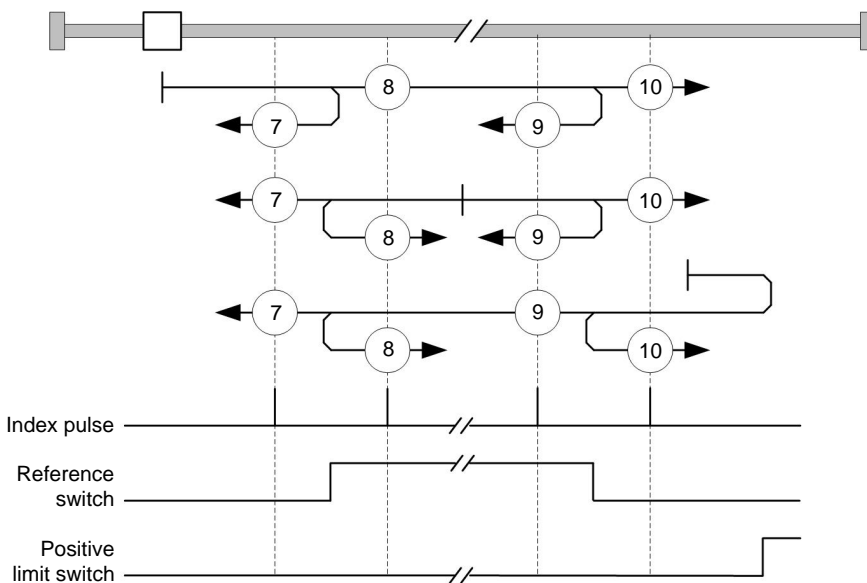

The methods 11 to 14 take the negative limit switch into account:

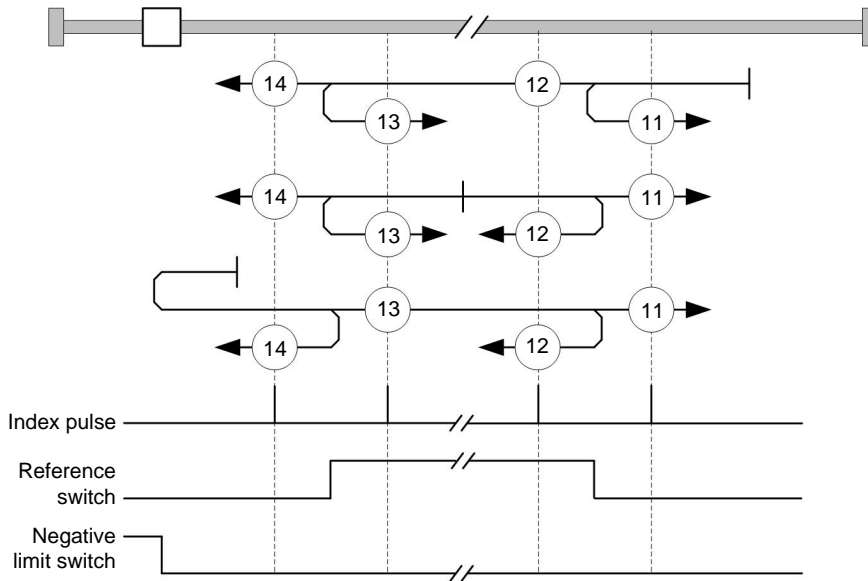

### Methods 17 and 18

These methods reference the limit switch without the index pulse.

Method 17 references the negative limit switch:

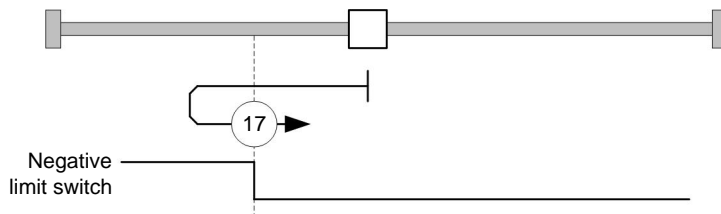

Method 18 references the positive limit switch:

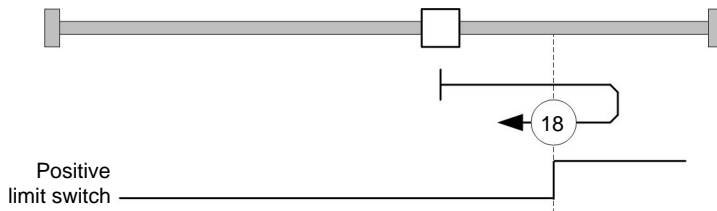

### Methods 19 to 22

These methods reference the switch flank of the reference switch without the index pulse.

In the methods 19 and 20 (equivalent to methods 3 and 4), the left switch flank of the reference switch is used as a reference:

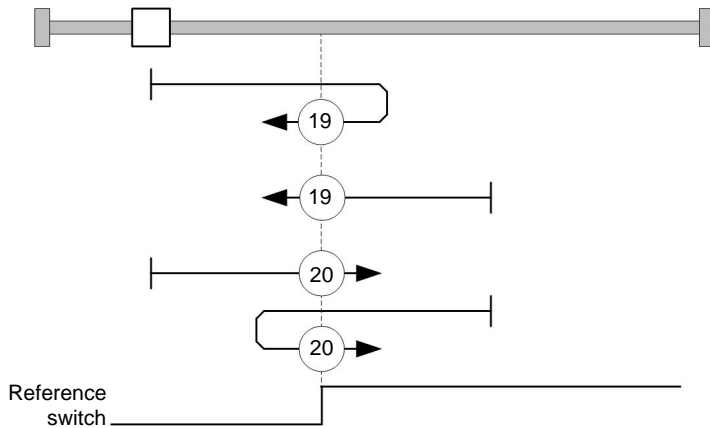

In the methods 21 and 22 (equivalent to methods 5 and 6), the right switch flank of the reference switch is used as a reference:

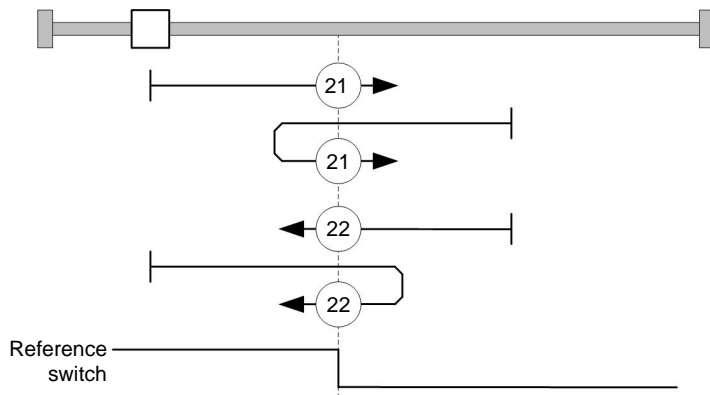

### Methods 23 to 30

These methods reference the home switch without the index pulse (with limit switches).

For these methods, the actual position relative to the reference switch is unimportant. With method 26, referencing is for instance always to the index pulse on the right next to the right flank of the reference switch.

The methods 23 to 26 take the positive limit switch into account:

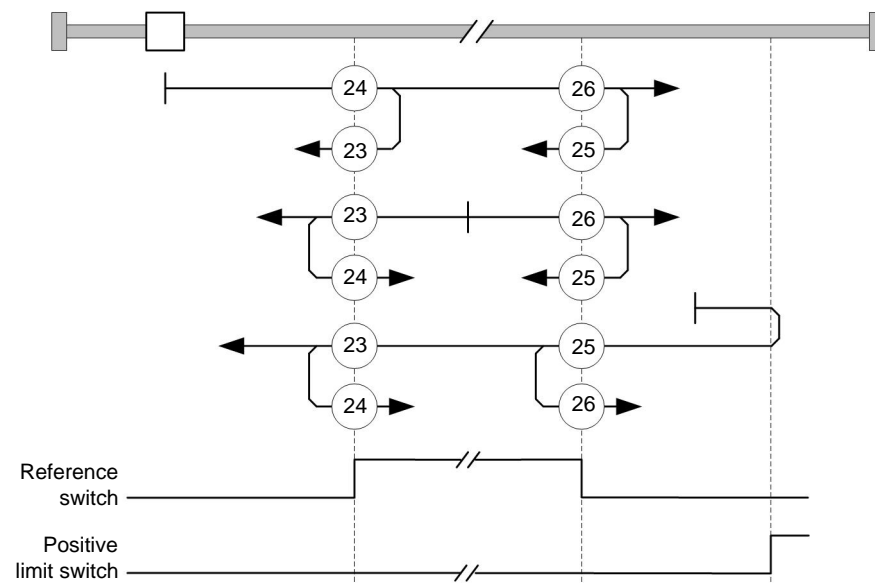

The methods 27 to 30 take the negative limit switch into account:



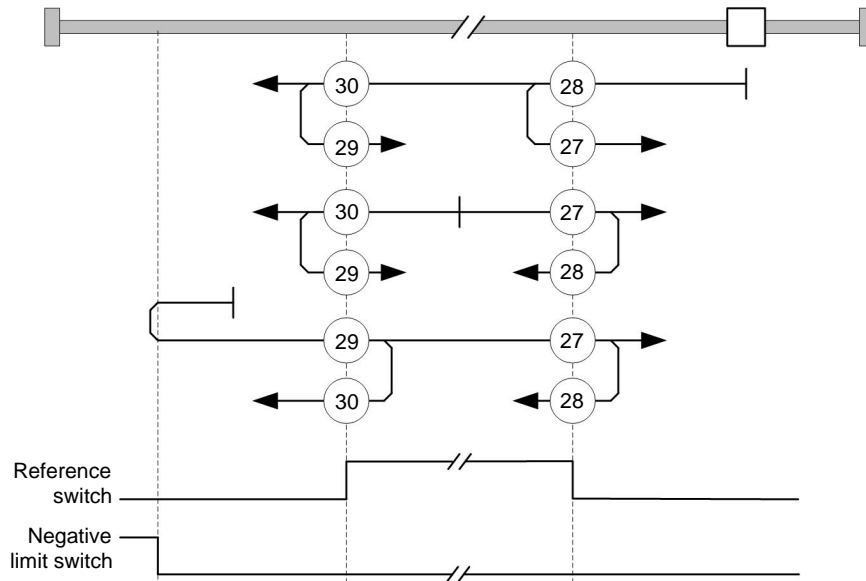

### Methods 33 and 34

Reference the next index pulse.

For these methods, referencing is only to respective next index pulse:

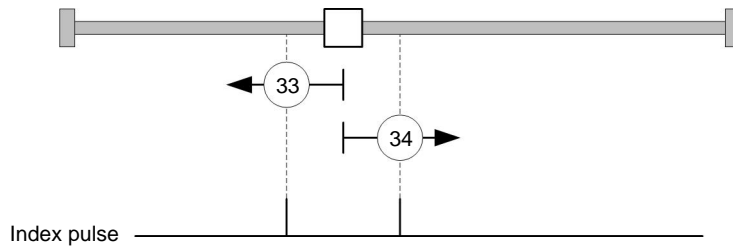

### Method 35

References to the actual position.

## 8.6 Cyclic Synchronous Position

### 8.6.1 Overview

#### Description

In this mode, the motor controller receives an absolute positional specification at fixed time intervals (called "cycles" below) via the field bus. In this case, the motor controller no longer computes ramps but only follows the specifications.

The target position is transferred via PDO, to which the motor controller responds promptly. Bit 4 in the control word does not have to be set (in contrast to **Profile Position** mode).

#### Note

The target specification is absolute and thus independent of how often it was sent per cycle.

#### Activation

To activate the mode, the value "8" must be set in object **6060<sub>h</sub>** (Modes Of Operation) (see "**DS402 Power State machine**").

### Control word

In this mode, the bits of control word **6040<sub>h</sub>** do not have a special function.

### Status word

The following bits in object **6041<sub>h</sub>** (status word) have a special function:

Bit	Value	Description
10	0	Reserved
10	1	Reserved
12	0	The motor controller does not follow the target specification; the specification of the <b>607A<sub>h</sub></b> (Target Position) is ignored.
12	1	The motor controller follows the target specification; the object <b>607A<sub>h</sub></b> (Target Position) is used as the input for the position control.
13	0	Reserved
13	1	Reserved

### 8.6.2 Object entries

The following objects are required to control this mode:

- **607A<sub>h</sub>** (Target Position): The position set value must be cyclically written to this object.
- **607B<sub>h</sub>** (Position Range Limit): This object contains the specification for an overflow or underflow of the position value.
- **607D<sub>h</sub>** (Software Position Limit): This object specifies the limits within which the position specification must be found (**607A<sub>h</sub>**).
- **6065<sub>h</sub>** (Following Error Window): This object specifies a tolerance corridor in both the positive and negative direction from the set specification. If the actual position is outside of this corridor for longer than the specified time (**6066<sub>h</sub>**), a "following error" is issued.
- **6066<sub>h</sub>** (Following Error Time Out): This object specifies the time period in milliseconds. If the actual position is outside of the position corridor (**6065<sub>h</sub>**) for longer than this time period, a "following error" is issued.
- **6085<sub>h</sub>** (Quick-Stop Deceleration): This object contains the deceleration in case a Quick Stop is triggered.
- **605A<sub>h</sub>** (Quick-Stop Option Code): This object contains the option that is to be executed in the event of a Quick Stop.
- **60C2<sub>h</sub>:01<sub>h</sub>** (Interpolation Time Period): This object specifies the time period of a cycle. Within this time period, a new set value must be written to **607A<sub>h</sub>**.

The following applies: cycle time = value of the **60C2<sub>h</sub>:01<sub>h</sub>** \* 10<sup>value of 60C2:02</sup> seconds.

At this time, only cycle times should be used that correspond to a power of two, i.e. 1, 2, 4, 8, 16, etc. The time unit of the cycle time is defined by object **60C2<sub>h</sub>:02<sub>h</sub>**.

- **60C2<sub>h</sub>:02<sub>h</sub>** (Interpolation Time Index): This object specifies the time basis for cycles. At this time, only the value **60C2<sub>h</sub>:02<sub>h</sub> = -3** is supported, which results in a time basis of 1 millisecond.
- **2031<sub>h</sub>** (Peak Current): This object specifies the maximum current in mA.

The following objects can be readout in this mode:

- **6064<sub>h</sub>** (Position Actual Value)
- **606C<sub>h</sub>** (Velocity Actual Value)
- **60F4<sub>h</sub>** (Following Error Actual Value)

## 8.7 Cyclic Synchronous Velocity

### 8.7.1 Overview

#### Description

In this mode, the motor controller receives a speed specification at fixed time intervals (called "cycles" below) via the field bus. In this case, the motor controller no longer computes ramps but only follows the specifications.

The target position is transferred via PDO, to which the motor controller responds promptly. Bit 4 in the control word does not have to be set (in contrast to **Profile Velocity** mode).

#### Activation

To activate the mode, the value "9" must be set in object **6060<sub>h</sub>** (Modes Of Operation) (see "**DS402 Power State machine**").

#### Control word

In this mode, the bits of control word **6040<sub>h</sub>** do not have a special function.

#### Status word

The following bits in object **6041<sub>h</sub>** (status word) have a special function:

Bit	Value	Description
10	0	Reserved
10	1	Reserved
12	0	The motor controller does not follow the target specification; the specification of the <b>60FF<sub>h</sub></b> (Target Velocity) is ignored.
12	1	The motor controller follows the target specification; the object <b>60FF<sub>h</sub></b> (Target Velocity) is used as the input for the position control.
13	0	No following error
13	1	Following error

### 8.7.2 Object entries

The following objects are required to control this mode:

- **60FF<sub>h</sub>** (Target Velocity): The speed set value must be cyclically written to this object.
- **6085<sub>h</sub>** (Quick-Stop Deceleration): This object contains the deceleration in case a Quick Stop is triggered (see "**DS402 Power State machine**").
- **605A<sub>h</sub>** (Quick-Stop Option Code): This object contains the option that is to be executed in the event of a Quick Stop (see "**DS402 Power State machine**").
- **60C2<sub>h</sub>:01<sub>h</sub>** (Interpolation Time Period): This object specifies the time period of a cycle. Within this time period, a new set value must be written to **60FF<sub>h</sub>**.

The following applies: cycle time = value of the **60C2<sub>h</sub>:01<sub>h</sub>** \* 10<sup>value of 60C2:02</sup> seconds.

At this time, only cycle times should be used that correspond to a power of two, i.e. 1, 2, 4, 8, 16, etc. The time unit of the cycle time is defined by object **60C2<sub>h</sub>:02<sub>h</sub>**.

- **60C2<sub>h</sub>:02<sub>h</sub>** (Interpolation Time Index): This object specifies the time basis for cycles. At this time, only the value **60C2<sub>h</sub>:02<sub>h</sub>=-3** is supported, which results in a time basis of 1 millisecond.
- **2031<sub>h</sub>** (Peak Current): This object specifies the maximum current in mA.

The following objects can be readout in this mode:

- **606C<sub>h</sub>** (Velocity Actual Value)
- **607E<sub>h</sub>** (Polarity)

## 8.8 Cyclic Synchronous Torque

### 8.8.1 Overview

#### Description

In this mode, the motor controller receives an absolute torque value at fixed time intervals (called "cycles" below) via the field bus. In this case, the motor controller no longer computes ramps but only follows the specifications.

The target position is transferred via PDO, to which the motor controller responds promptly. Bit 4 in the control word does not have to be set (in contrast to **Profile Torque** mode).

#### Activation

To activate the mode, the value "10" must be set in object **6060<sub>h</sub>** (Modes Of Operation) (see "**DS402 Power State machine**").

#### Control word

In this mode, the bits of control word **6040<sub>h</sub>** do not have a special function.

#### Status word

The following bits in object **6041<sub>h</sub>** (status word) have a special function:

Bit	Value	Description
10	0	Reserved
10	1	Reserved
12	0	The motor controller does not follow the target specification; the specification of the <b>6071<sub>h</sub></b> (Target Torque) is ignored.
12	1	The motor controller follows the target specification; the object <b>6071<sub>h</sub></b> (Target Torque) is used as the input for the position control.
13	0	Reserved
13	1	Reserved

### 8.8.2 Object entries

The following objects are required to control this mode:

- **6071<sub>h</sub>** (Target Torque): The torque set value must be cyclically written to this object.
- **60C2<sub>h</sub>:01<sub>h</sub>** (Interpolation Time Period): This object specifies the time period of a cycle. Within this time period, a new set value must be written to **60FF<sub>h</sub>**.

The following applies: cycle time = value of the **60C2<sub>h</sub>:01<sub>h</sub>** \* 10<sup>value of 60C2:02</sup> seconds.

At this time, only cycle times should be used that correspond to a power of two, i.e. 1, 2, 4, 8, 16, etc. The time unit of the cycle time is defined by object **60C2<sub>h</sub>:02<sub>h</sub>**.

- **60C2<sub>h</sub>:02<sub>h</sub>** (Interpolation Time Index): This object specifies the time basis for cycles. At this time, only the value **60C2<sub>h</sub>:02<sub>h</sub>=-3** is supported, which results in a time basis of 1 millisecond.
- **2031<sub>h</sub>** (Peak Current): This object specifies the maximum current in mA.

The following object can be readout in this mode:

- **606C<sub>h</sub>** (Velocity Actual Value)

## 8.9 Clock/direction mode

### 8.9.1 Description

This mode is equivalent to the velocity mode but uses pulses of two input pins as target.

### 8.9.2 Activation

The activation is not done via the object dictionary but a DIP-switch. For the settings of the switches see chapter "" nach.

The activation of this mode is done by setting the "Mode of Operation" **6060<sub>h</sub>** to the value "-1" (resp. "FF<sub>h</sub>").

### 8.9.3 General

The following data apply to all sub modes of the clock/direction mode:

- The maximum frequency of the input pulses are limited at 1MHz, the ON-part is not allowed to get shorter than 200 ns.

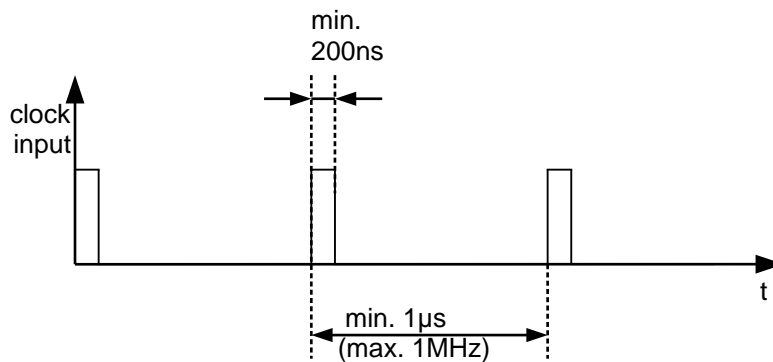

- The scaling of the steps is done via the objects **2057<sub>h</sub>** and **2058<sub>h</sub>**. The following formula is applied:

$$\text{step width per pulse} = \frac{2057h}{2058h}$$

By default the value for "step width per pulse" is "512", which is equal a full step per pulse. A half step is the value "256", a quarter step accordingly "128" and so on.

#### Note

During a change of direction it is necessary to let the time of 35µs lapse away before applying a new clock.

### 8.9.4 Sub modes of the clock/direction mode

#### Clock/direction-mode (CD-Modus)

In this mode the clock pulses have to be put to the "clock input", the direction signal is affection the direction (see following image).

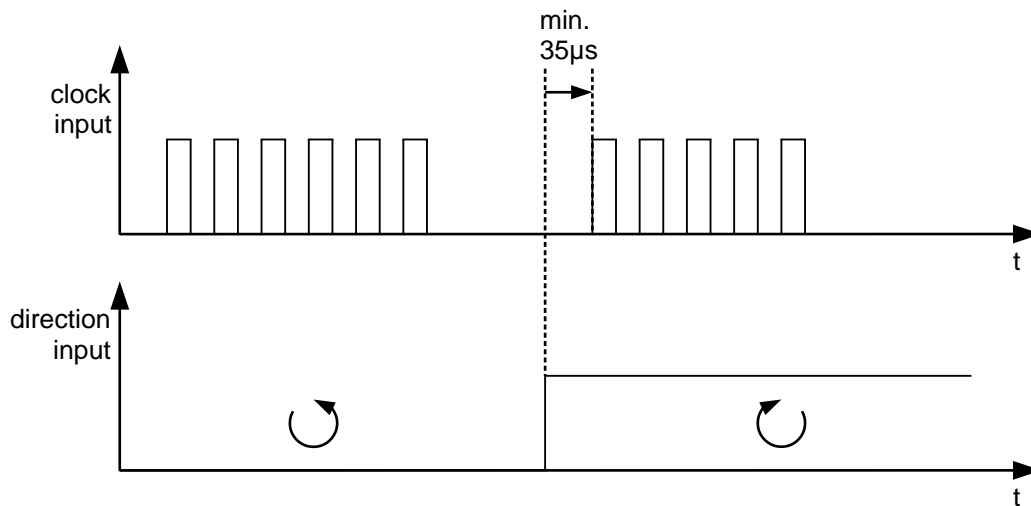

### Clockwise/counterclockwise mode (CW/CCW-mode)

The object **205B<sub>h</sub>** needs to be set to "1" in order to activate this mode.

In this sub mode the used input determines the direction of rotation (see following image).

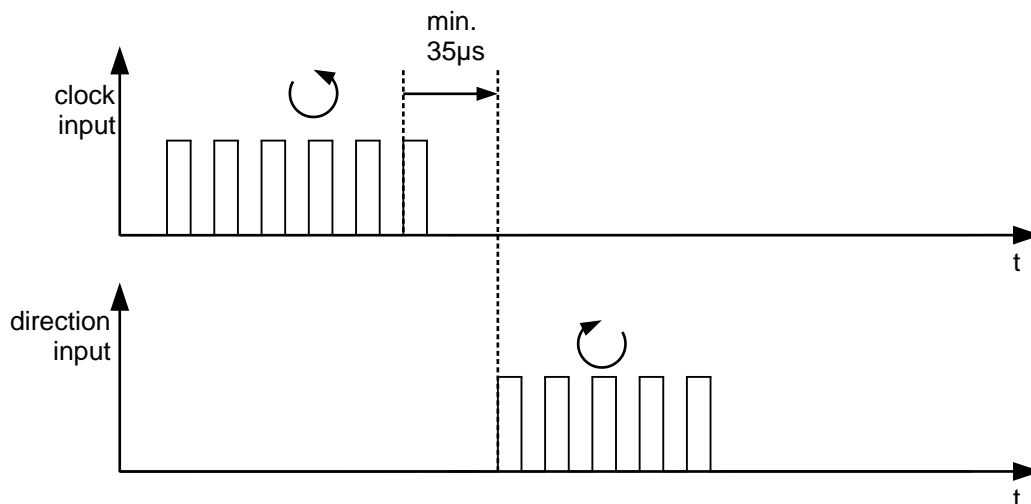

## 8.10 Auto-setup mode

### 8.10.1 Overview

#### Notes

### CAUTION

Prerequisites for performing the auto setup are:

- The motor must be load-free.
- The motor must not be touched.
- The motor must be able to rotate freely in any direction.

Complex computations are performed during auto setup. Often this results in a lack of sufficient computing power to operate the field buses in a timely manner. The buses may be impaired during auto setup.

### Description

The auto-setup function ascertains the following data of the connected motor in the course of multiple testing and measuring cycles:

- Pole pair count
- Encoder resolution
- Index width
- Alignment (shifting of the electrical zero point to the index)
- Compensation of encoder running inaccuracies

### Activation

To activate the mode, the value "-2" (=FE<sub>h</sub>) must be set in object 6060<sub>h</sub> (Modes Of Operation).

### Control word

The following bits in object 6040<sub>h</sub> have a special function:

- Bit 4: Starts the auto setup. The start is carried out on a transition of "0" to "1".
- Bit 6: With "0", all values are determined; with "1", only the encoder for the closed loop mode is measured (alignment, smooth running). For this purpose, the pole pair count (2030<sub>h</sub>) and encoder resolution (2052<sub>h</sub>) values must be preassigned.

### Status word

The following bits in object 6041<sub>h</sub> have a special function:

- Bit 10: Indexed: This bit is set to "1" when the index is overrun the first time.
- Bit 12: Aligned: This bit is set to "1" after the encoder alignment is performed.
- Bit 13: Optimized: This bit is set to "1" after the encoder concentricity measurement is performed.

### Two phases

The auto setup procedure is subdivided into two phases:

- Measurement (see "**Measurement**")
- Parameter test (see "**Parameter test**")

## 8.10.2 Measurement

### Description

In this step, the motor parameters required for the open loop modes and closed loop modes are determined one after the other.

### Error

During measurement, the following errors (1003<sub>h</sub>) can occur:

Error code	Description	Solution approach
09207305 <sub>h</sub>	A/B pulses were not detected while the motor was rotating.	Is an encoder connected?  Are the A and B tracks correctly connected?
07207305 <sub>h</sub>	Sensor fault. Occurs when a shift in the index position is detected. To correct the fault, the motor controller must be unplugged and plugged in again.	Is the shield at the encoder line correctly connected?

Error code	Description	Solution approach
08207305 <sub>h</sub>	The index pulse was not detected.	Is the index correctly connected? Does the motor have a higher pole pair count than 200?

### Completion

After measurement, the motor controller restarts automatically and performs the parameter test (see "Parameter test").

### 8.10.3 Parameter test

#### Test

In this step, the drive is automatically switched into the profile torque mode and the field-generating current  $I_d$  is gradually increased until the maximum current (2031<sub>h</sub>) is reached or the motor begins to move.

The reached current level is used as a benchmark for the grade of the measured parameter. Ideally, the current  $I_d$  can be increased without the motor moving.

#### Completion

If the current level is over 50% of the maximum current (2031<sub>h</sub>), the test is closed with a positive result.

After the end of the test, the motor controller restarts automatically and becomes operational again.

### 8.10.4 Test result and parameter file

#### Test result

The test result can be read out in bit 15 of object 6041<sub>h</sub>. If this bit is set, the test was successful and closed loop mode is possible.

If the bit is deleted, closed loop mode is possible but the parameters are not optimal.

#### Parameters

The parameters that are determined during auto setup are stored in the file `fs/config/startup/tuning.on` and are transferred to the following objects of the object directory with every restart.

Index	Subindex	Description	Remark
2030 <sub>h</sub>	00 <sub>h</sub>	Pole pair count	E.g. 50 (equivalent to 200 poles)
2050 <sub>h</sub>	00 <sub>h</sub>	Encoder alignment	Between 0 and 65535
2051 <sub>h</sub>	01 <sub>h</sub>	Frequency of the encoder correction	
2051 <sub>h</sub>	02 <sub>h</sub>	Amplitude of the encoder correction	
2051 <sub>h</sub>	03 <sub>h</sub>	Shifting of the encoder correction	
2052 <sub>h</sub>	01 <sub>h</sub>	Physical encoder resolution	e.g. 2000
2053 <sub>h</sub>	02 <sub>h</sub>	Index polarity	0 = normal, 1 = inverted
2054 <sub>h</sub>	03 <sub>h</sub>	Index width	Internal operand or FFFFFFFF <sub>h</sub> (-1) to switch off the encoder monitoring.



## 9 Special functions

### 9.1 Digital inputs and outputs

The motor controller has digital inputs and outputs.

#### Note

The length of the input lead at digital inputs with 5V shall not exceed 3 meter.

#### 9.1.1 Digital inputs

##### Overview

#### Note

The digital inputs are sampled only once a millisecond. Changes in the input signal shorter than one millisecond cannot be processed.

The following inputs are available:

Input	Special Function	Signal threshold switchable	Differential / single ended
1	Negative limit switch	yes, 5 V or 24 V (see <b>3240<sub>h</sub>:06<sub>h</sub></b> )	single ended
2	Positive limit switch	yes, 5 V or 24 V (see <b>3240<sub>h</sub>:06<sub>h</sub></b> )	single ended
3	Limit switch / Direction input in clock/direction mode	yes, 5 V or 24 V (see <b>3240<sub>h</sub>:06<sub>h</sub></b> )	single ended
4	Clock input in clock/direction mode	yes, 5 V or 24 V (see <b>3240<sub>h</sub>:06<sub>h</sub></b> )	single ended
5	no	no, 5 V bis 24 V Weitbereichsinput	single ended
6	no	no, 5 V bis 24 V Weitbereichsinput	single ended

##### Object entries

The following OD settings can be used to manipulate the value of an input, in which case only the bit that corresponds to that input will have an effect:

- **3240<sub>h</sub>:01<sub>h</sub>**

This bit is used to switch the special functions of an input on (value "0") or off (value "1"). If input 1 is not to be used as a negative limit switch, for example, the special function must be switched off so that the signal encoder is not erroneously responded to. The object has no effects on bits 16 to 31.

The firmware evaluates the following bits during a reference run (homing method):

- Bit 0: negative limit switch
- Bit 1: positive limit switch
- Bit 2: reference switch

- **3240<sub>h</sub>:02<sub>h</sub>**

This bit changes from closer logic (a logical high level at the input yields the value of "1" in object **60FD<sub>h</sub>**) to opener logic (the logical high level at the input yields the value of "0"). This applies to the special functions (except the clock and directional inputs) and for the normal input. The input is set as closer logic if the corresponding bit is "0", it is set to opener logic with the value "1" respectively.

- **3240<sub>h</sub>:03<sub>h</sub>**

This bit switches on software simulation of the input values when it is set to "1". In this case, the actual values are no longer used; the values set in object **3240<sub>h</sub>:04<sub>h</sub>** for the respective input are used instead.

- **3240<sub>h</sub>:04<sub>h</sub>**

This bit specifies the value to be read in as the input value if the same bit was set in object **3240<sub>h</sub>:03<sub>h</sub>**.

- **3240<sub>h</sub>:05<sub>h</sub>**

This object contains the unmodified input value.

### Computation of the inputs

Computation of the input using input 1 as an example:

The value of bit 0 of object **60FD<sub>h</sub>** is interpreted by the firmware as a negative limitation switch, and the result of the complete computation is stored in bit 16.

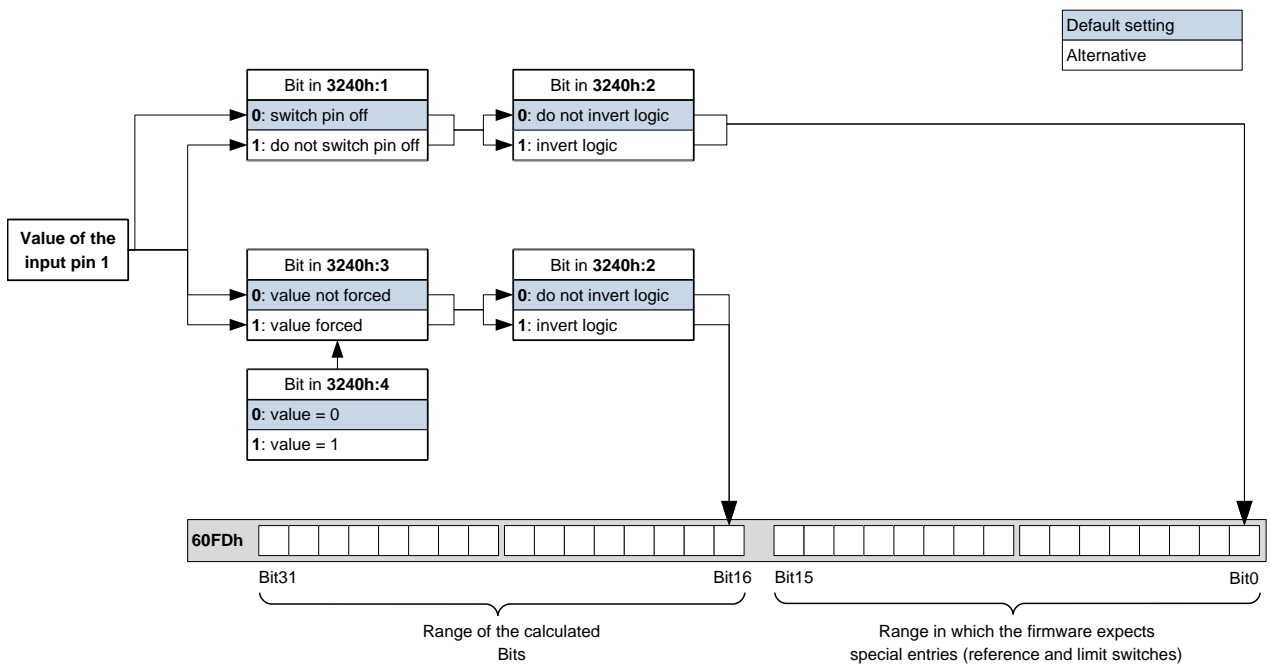

## 9.1.2 Digital outputs

### Outputs

The outputs are controlled using object **60FE<sub>h</sub>**. Output 1 corresponds to bit 16 in object **60FE<sub>h</sub>**, output 2 corresponds to bit 17, etc., as with the inputs. The outputs with special functions are again entered in the firmware in the lower bits 0 to 15. Currently only bit 0 is assigned that controls the motor brake.

### Object entries

Additional OD entries exist for manipulating the value of the outputs (see the following example for details). Similar to the inputs, only the bit at the corresponding position always has an effect on the respective output:

- **3250<sub>h</sub>:02<sub>h</sub>**

This can be used to change the logic from "closer" to "opener". When configured as a "closer", the outputs a logical high level if the bit is "1". When configured as an "opener", the outputs a logical low level if there is a "1" in object **60FE<sub>h</sub>**.

- **3250<sub>h</sub>:03<sub>h</sub>**

If a bit is set in **3250<sub>h</sub>**, the output is manually controlled. The value for the output is then contained in object **3250<sub>h</sub>:04<sub>h</sub>**, which is also possible for the brake output.

- **3250<sub>h</sub>:04<sub>h</sub>**

The bits in this object specify the output value that is to be applied to the output when the manual control of the output is activated by object **3250<sub>h</sub>:03<sub>h</sub>**.

- **3250<sub>h</sub>:05<sub>h</sub>**

This object does not have any function and is included for compatibility reasons.

### Bits of the outputs

Example of the computation of the bits for the outputs:

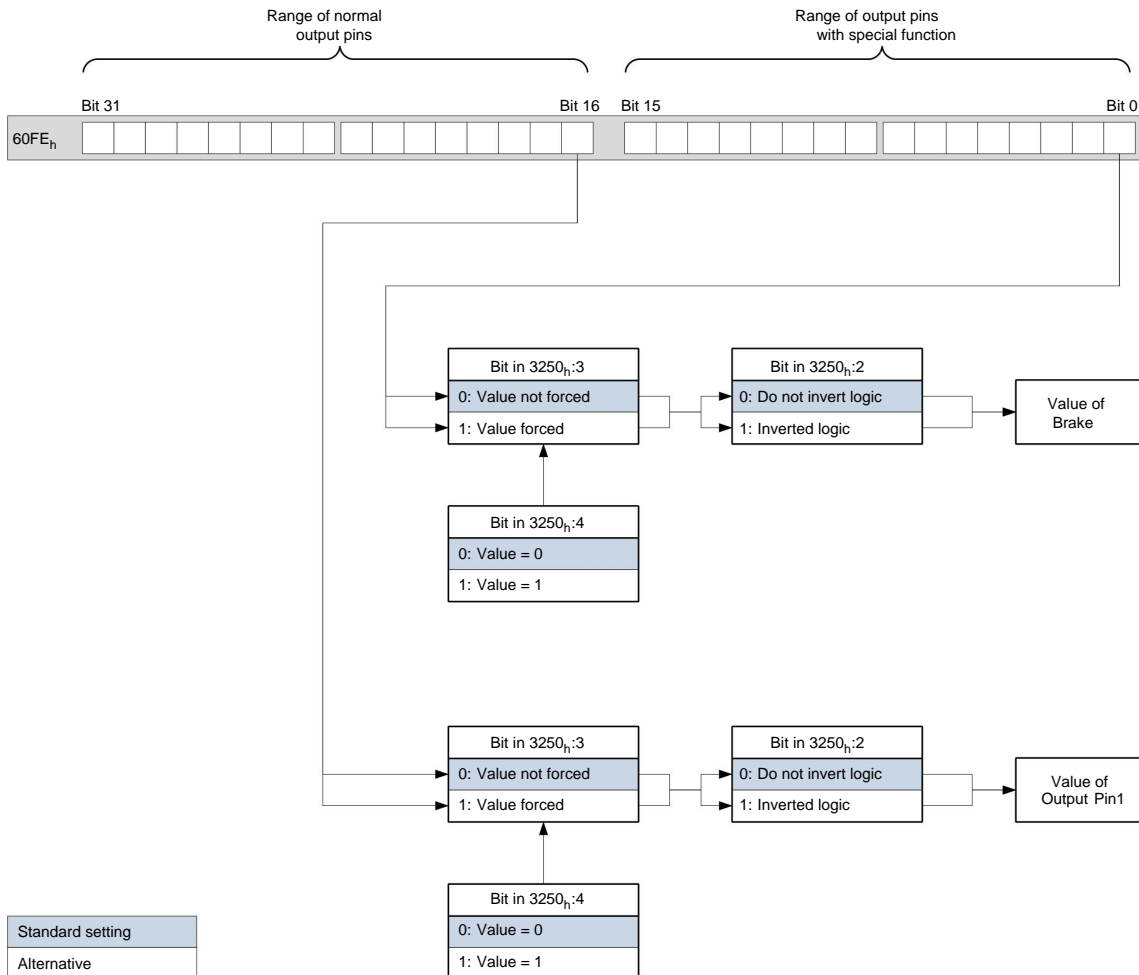

## 9.2 Automatic brake controller

### 9.2.1 Description

The current switch-off and brake control are active when the motor is stationary for an extended period or is to be accelerated from a standstill. These functions are not supported by the synchronous operating modes. Apart from this, they are always available, independent of the set operating mode (**6060<sub>h</sub>**).

The brake output of the motor controller results in a PWM signal whose frequency and duty cycle can be set.

The brake output is located at connector X4 (see also the "**Brake output (connector X4)**" section).

### 9.2.2 Activation and connection

The brake control can be controlled with bit 2 of object **3202<sub>h</sub>**. If the bit is set to "1", the brake controller is activated; if set to "0", the motor controller will not use the brake. The brake can also be manually

controlled via bit 0 in **60FE<sub>h</sub>** and can be manipulated with the objects for the settings for the digital outputs (see "**Digital inputs and outputs**").

**! CAUTION**

When the brake is used manually, the firmware needs to be instructed not to use the brake control (**3202<sub>h</sub>** bit 2 at "0")..

**9.2.3 Braking the motor**

When the motor comes to a standstill, the brake is activated after the time **2038<sub>h</sub>:1<sub>h</sub>** expires. After the time **2038<sub>h</sub>:2<sub>h</sub>** expires, the motor current is switched off.

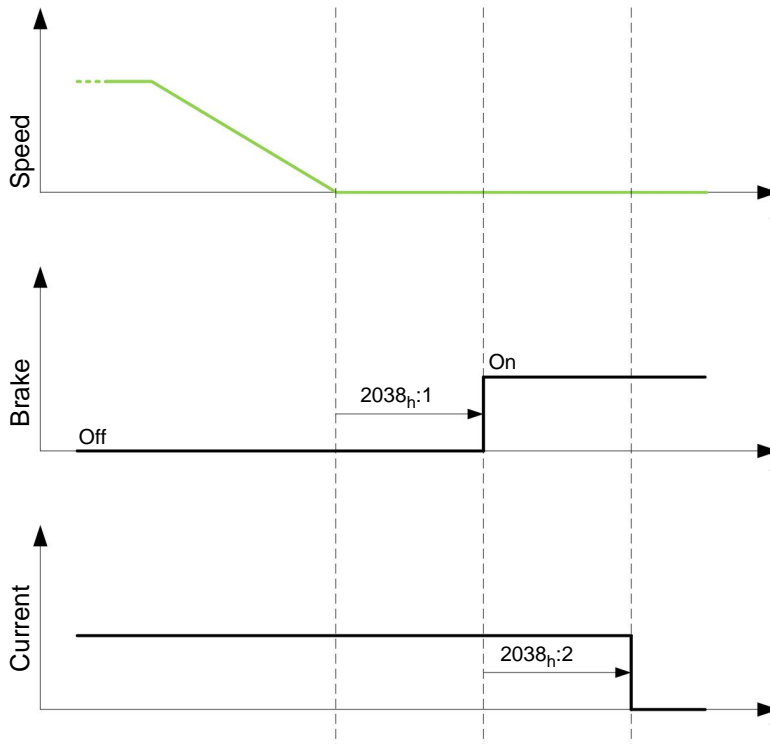

**9.2.4 Setting a new move command**

After a new move command is issued, the current is switched on again immediately; the brake is disengaged after the wait period **2038<sub>h</sub>:3<sub>h</sub>** has expired. Then another period **2038<sub>h</sub>:4<sub>h</sub>** elapses before movement begins.

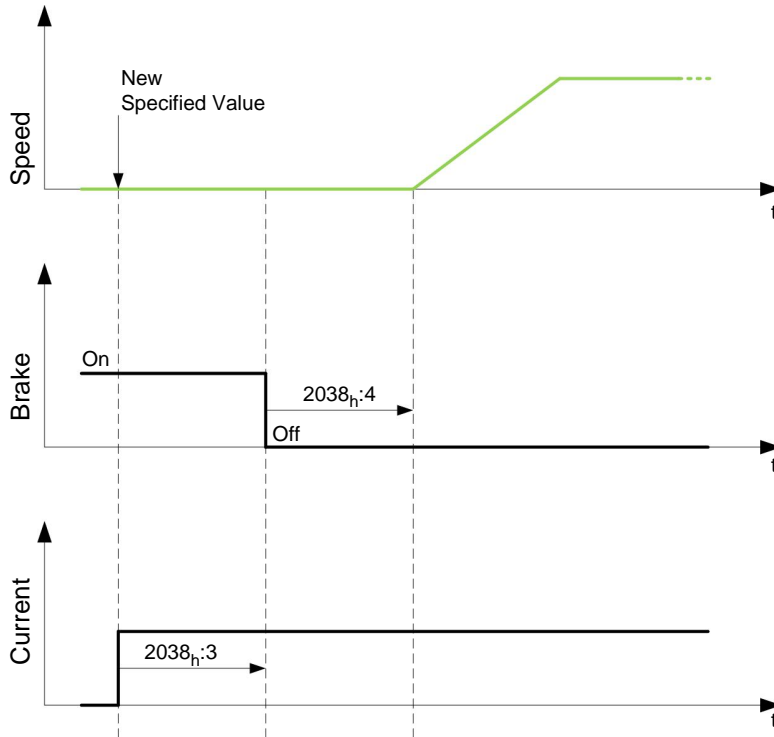

### 9.2.5 Brake PWM

The switched-on brake generates a PWM signal at the output of the motor controller whose duty cycle and frequency can be set. If an output pin without PWM is required, a duty cycle of 100 percent can be set.

#### Frequency

The frequency of the brake PWM can be set in object **2038<sub>h</sub>:5<sub>h</sub>**. The unit is hertz; a value greater than 2000 is not possible.

#### Duty cycle

The duty cycle – the relationship of the pulse duration to the period duration – is set in **2038<sub>h</sub>:6<sub>h</sub>**. The value is interpreted as a percentage and can be set between 1 and 100. At a value of 100, the output pin is switched on permanently.

The figure below shows an example of duty cycles of 25 and 50 percent with the same frequency.

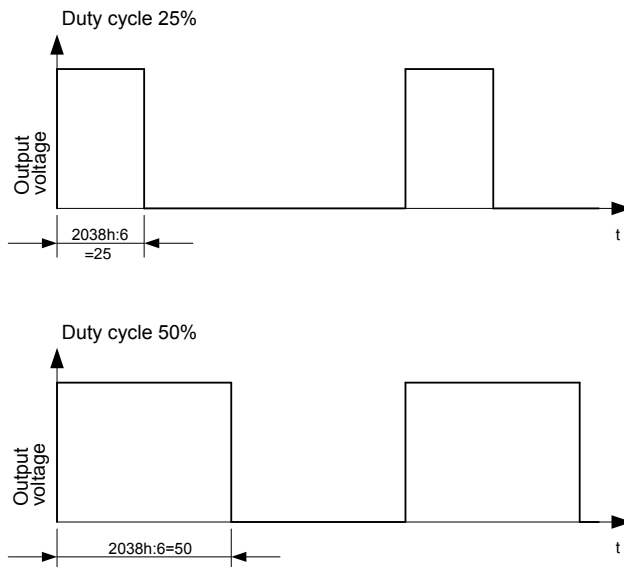

## 9.3 I<sup>2</sup>t motor overload protection

### 9.3.1 Description

I<sup>2</sup>t motor overload protection has the goal of preventing damage to the motor and of simultaneously operating it normally at its thermal limit.

The function is only available when the motor controller is in closed loop operating mode (bit 0 of object **3202<sub>h</sub>** set to "1") and the motor is **not** in profile torque mode or cycle synchronous torque mode.

There is a single exception: If I<sup>2</sup>t is activated open loop mode, the current is limited to the set nominal current even when the set maximum current is greater. This feature was implemented for safety reasons, so that it is also possible to switch out of closed loop mode and into open loop mode with a very high short-time maximum current without damaging the motor.

### 9.3.2 Object entries

The following objects affect I<sup>2</sup>t motor overload protection:

- **2031<sub>h</sub>**: Peak Current - specifies the maximum current in mA.
- **203B<sub>h</sub>:1<sub>h</sub>** Nominal Current - specifies the nominal current in mA.
- **203B<sub>h</sub>:2<sub>h</sub>** Maximum Duration Of Peak Current - specifies the maximum time period of the maximum current in ms.

The following objects indicate the actual state of I<sup>2</sup>t:

- **203B<sub>h</sub>:3<sub>h</sub>** Threshold - specifies the limit in mA, from which is determined whether switching is to the maximum current or nominal current.
- **203B<sub>h</sub>:4<sub>h</sub>** CalcValue - specifies the calculated value that is compared to the threshold in order to set the current.
- **203B<sub>h</sub>:5<sub>h</sub>** LimitedCurrent - shows the actual current value that was set by I<sup>2</sup>t.
- **203B<sub>h</sub>:6<sub>h</sub>** Status:
  - Value = "0": I<sup>2</sup>t deactivated
  - Value = "1": I<sup>2</sup>t activated

### 9.3.3 Activation

The three object entries above must have been appropriately specified to activate the mode. This means that the maximum current must be greater than the nominal current, and a time value must be entered for the maximum time of the maximum current. I<sup>2</sup>t operability remains deactivated when these conditions are not satisfied.

### 9.3.4 Function of $I^2t$

A  $I^2T_{Lim}$  is calculated by specifying the nominal current, maximum current, and maximum time period for the maximum current.

The motor can run with maximum current until the calculated  $I^2T_{Lim}$  is reached. The current is then immediately reduced to the nominal current.

The following diagram again shows the interactions.

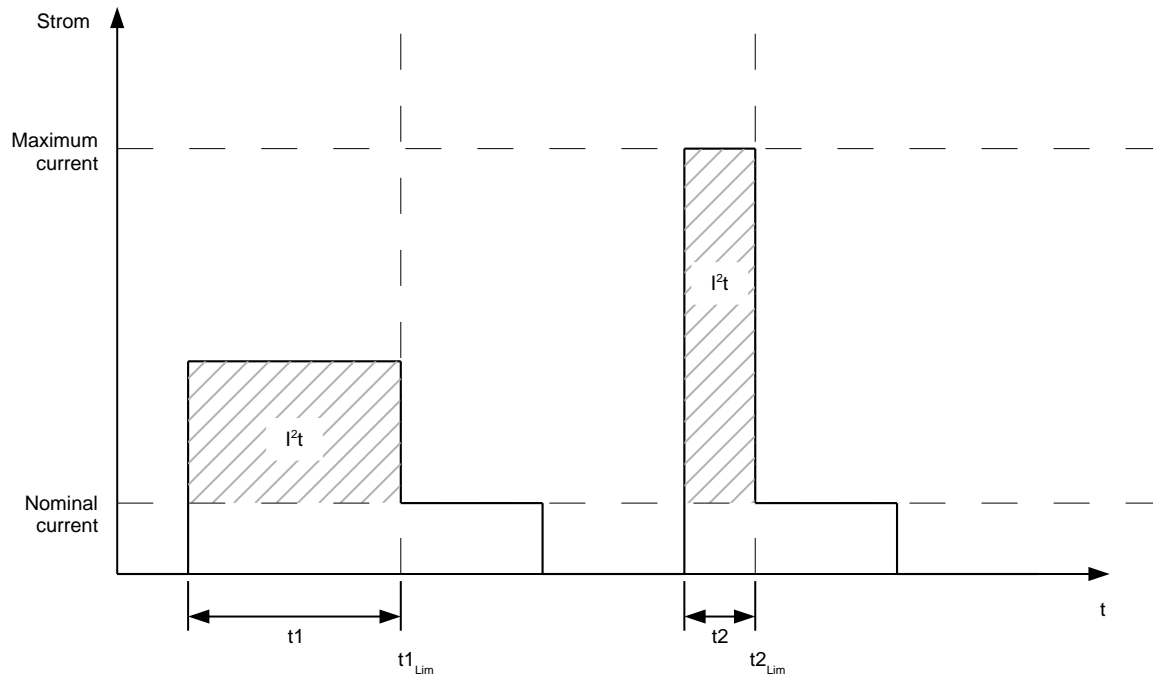

In the first section  $t_1$ , the current value is higher than the nominal current. At time  $t_{1\_Lim}$ ,  $I^2t_{Lim}$  is reached and the current is limited to the nominal current. During the following time period  $t_2$ , a current comes that corresponds to the maximum current. Accordingly, the value for  $I^2t_{Lim}$  is reached faster than in time period  $t_1$ .

## 9.4 Save Objects



### CAUTION

The incorrect use of this feature may cause the controller not be able to start again. Therefore read the chapter completely before using this feature.

### 9.4.1 General information

A subset of objects can be stored and will get loaded automatically with the next start. Moreover the values will be kept during a firmware update.

Only whole sets of objects (called "categories") can be stored, it is not possible to store single objects.

An object belongs to one of the following categories:

1. The object is not savable.
2. The object is related to the communication (e.g. fieldbus) so it belongs to the category "communication".
3. The object holds general application information so it belongs to the category "application"

In chapter " **Object directory description**" - with the list of all objects - the ability to get saved is described for each object.

#### 9.4.2 Category: not savable

The not savable objects are ignored in the process of saving. All status and control words and all objects depending on the status of the controller are ranked among this category.

#### 9.4.3 Category: communication objects

All objects controlling the fieldbus are ranked among this category.

The following objects are considered to be a communication object:

- **1005<sub>h</sub>**: COB-ID Sync
- **1007<sub>h</sub>**: Synchronous Window Length
- **100C<sub>h</sub>**: Guard Time
- **100D<sub>h</sub>**: Live Time Factor
- **1014<sub>h</sub>**: COB-ID EMCY
- **1017<sub>h</sub>**: Producer Heartbeat Time
- **1400<sub>h</sub>**: Receive PDO 1 Communication Parameter
- **1401<sub>h</sub>**: Receive PDO 2 Communication Parameter
- **1402<sub>h</sub>**: Receive PDO 3 Communication Parameter
- **1403<sub>h</sub>**: Receive PDO 4 Communication Parameter
- **1600<sub>h</sub>**: Receive PDO 1 Mapping Parameter
- **1601<sub>h</sub>**: Receive PDO 2 Mapping Parameter
- **1602<sub>h</sub>**: Receive PDO 3 Mapping Parameter
- **1603<sub>h</sub>**: Receive PDO 4 Mapping Parameter
- **1800<sub>h</sub>**: Transmit PDO 1 Communication Parameter
- **1801<sub>h</sub>**: Transmit PDO 2 Communication Parameter
- **1802<sub>h</sub>**: Transmit PDO 3 Communication Parameter
- **1803<sub>h</sub>**: Transmit PDO 4 Communication Parameter
- **1A00<sub>h</sub>**: Transmit PDO 1 Mapping Parameter
- **1A01<sub>h</sub>**: Transmit PDO 2 Mapping Parameter
- **1A02<sub>h</sub>**: Transmit PDO 3 Mapping Parameter
- **1A03<sub>h</sub>**: Transmit PDO 4 Mapping Parameter
- **2005<sub>h</sub>**: CANopen Baudrate
- **2009<sub>h</sub>**: CANopen NodeID
- **2010<sub>h</sub>**: IP-Configuration
- **2011<sub>h</sub>**: Static-IPv4-Address
- **2012<sub>h</sub>**: Static-IPv4-Subnet-Mask

#### 9.4.4 Category: application objects

The following objects are considered to be a user object:

- **2031<sub>h</sub>**: Peak Current
- **2032<sub>h</sub>**: Maximum Speed
- **2033<sub>h</sub>**: Plunger Block
- **2034<sub>h</sub>**: Upper Voltage Warning Level
- **2035<sub>h</sub>**: Lower Voltage Warning Level
- **2036<sub>h</sub>**: Open Loop Current Reduction Idle Time
- **2037<sub>h</sub>**: Open Loop Current Reduction Value/factor
- **2038<sub>h</sub>**: Brake Controller Timing
- **2056<sub>h</sub>**: Limit Switch Tolerance Band
- **2057<sub>h</sub>**: Clock Direction Multiplier
- **2058<sub>h</sub>**: Clock Direction Divider
- **2059<sub>h</sub>**: Encoder Configuration
- **205B<sub>h</sub>**: Clock Direction Or Clockwise/Counter Clockwise Mode
- **2060<sub>h</sub>**: Compensate Polepair Count



- **2061<sub>h</sub>**: Velocity Numerator
- **2062<sub>h</sub>**: Velocity Denominator
- **2063<sub>h</sub>**: Acceleration Numerator
- **2064<sub>h</sub>**: Acceleration Denominator
- **2065<sub>h</sub>**: Jerk Numerator
- **2066<sub>h</sub>**: Jerk Denominator
- **2067<sub>h</sub>**: Jerk Limit (internal)
- **2084<sub>h</sub>**: Bootup Delay
- **2300<sub>h</sub>**: NanoJ Control
- **2303<sub>h</sub>**: Number Of Active User Program
- **2304<sub>h</sub>**: Table Of Available User Programs
- **2310<sub>h</sub>**: NanoJ Input Data Selection
- **2320<sub>h</sub>**: NanoJ Output Data Selection
- **2330<sub>h</sub>**: NanoJ In/output Data Selection
- **2410<sub>h</sub>**: NanoJ Init Parameters
- **3202<sub>h</sub>**: Motor Drive Submode Select
- **320A<sub>h</sub>**: Motor Drive Sensor Display Open Loop
- **320B<sub>h</sub>**: Motor Drive Sensor Display Closed Loop
- **3210<sub>h</sub>**: Motor Drive Parameter Set
- **3212<sub>h</sub>**: Motor Drive Flags
- **3221<sub>h</sub>**: Analogue Inputs Control
- **3240<sub>h</sub>**: Digital Inputs Control
- **3250<sub>h</sub>**: Digital Outputs Control
- **3321<sub>h</sub>**: Analogue Input Offset
- **3322<sub>h</sub>**: Analogue Input Pre-scaling
- **3700<sub>h</sub>**: Following Error Option Code
- **6046<sub>h</sub>**: VI Velocity Min Max Amount
- **6048<sub>h</sub>**: VI Velocity Acceleration
- **6049<sub>h</sub>**: VI Velocity Deceleration
- **604A<sub>h</sub>**: VI Velocity Quick Stop
- **604C<sub>h</sub>**: VI Dimension Factor
- **605A<sub>h</sub>**: Quick Stop Option Code
- **605B<sub>h</sub>**: Shutdown Option Code
- **605C<sub>h</sub>**: Disable Option Code
- **605D<sub>h</sub>**: Halt Option Code
- **605E<sub>h</sub>**: Fault Option Code
- **6065<sub>h</sub>**: Following Error Window
- **6066<sub>h</sub>**: Following Error Time Out
- **6067<sub>h</sub>**: Position Window
- **6068<sub>h</sub>**: Position Window Time
- **6072<sub>h</sub>**: Max Torque
- **607B<sub>h</sub>**: Position Range Limit
- **607C<sub>h</sub>**: Home Offset
- **607D<sub>h</sub>**: Software Position Limit
- **607E<sub>h</sub>**: Polarity
- **6081<sub>h</sub>**: Profile Velocity
- **6082<sub>h</sub>**: End Velocity
- **6083<sub>h</sub>**: Profile Acceleration
- **6084<sub>h</sub>**: Profile Deceleration
- **6085<sub>h</sub>**: Quick Stop Deceleration
- **6086<sub>h</sub>**: Motion Profile Type
- **6087<sub>h</sub>**: Torque Slope
- **608F<sub>h</sub>**: Position Encoder Resolution

- **6091<sub>h</sub>**: Gear Ratio
- **6092<sub>h</sub>**: Feed Constant
- **6098<sub>h</sub>**: Homing Method
- **6099<sub>h</sub>**: Homing Speed
- **609A<sub>h</sub>**: Homing Acceleration
- **60A4<sub>h</sub>**: Profile Jerk
- **60C2<sub>h</sub>**: Interpolation Time Period
- **60C5<sub>h</sub>**: Max Acceleration
- **60C6<sub>h</sub>**: Max Deceleration

#### 9.4.5 Starting save process

### CAUTION

- The motor has to stand still during the process of saving and is not allowed to get approached while saving.
- While saving the function of the fieldbus may be affected.
- The process of saving may need – depending on the type of controller – up to ten seconds. Never disconnect the power supply during this period. The nonobservance may led to an broken file system, as a result the controller gets unusable.
- Therefore always wait for the controller to signal the successful process of saving with the value "1" in the correspondent subindex in object **1010<sub>h</sub>**.

For each category there is a subindex in object **1010<sub>h</sub>**. The only thing to do to save all objects of that category is to write the value  $65766173_{16}$ <sup>1</sup> to the subindex. The end of the save process will be signalled by the controller by writing the value "1" to the subindex.

The following table lists, which subentry of the object **1010<sub>h</sub>** is related to which category.

Subindex	Category
01 <sub>h</sub>	All categorieis
02 <sub>h</sub>	Communication
03 <sub>h</sub>	Application

#### 9.4.6 Drop saved objects

### CAUTION

After deleting the saved values the controller will reboot.

To drop all saved objects or a category of saved objects the value  $64616F6C_{16}$  needs to be written to the object **1011<sub>h</sub>**<sup>2</sup>. The following subindexes are related to a category:

Subindex	Category
01 <sub>h</sub>	All categorieis (reset to factory default)
02 <sub>h</sub>	Communication
03 <sub>h</sub>	Application

Thereupon the saved objects will get deleted. The controller will reboot after deleting the values.

<sup>1</sup> This corresponds to decimal  $1702257011_{10}$  or the ASCII string " save"

<sup>2</sup> This corresponds to decimal  $1684107116_{10}$  or the ASCII string " load"

## 10 Programming with NanoJ

### 10.1 Introduction

The VMM (Virtual Machine Monitor) is a protected execution environment within the firmware. The user can load his or her own programs ("User Program") in this environment via the web interface. These can trigger functions in the motor controller, for example by reading or writing entries in the object directory.

The use of protective mechanisms makes it impossible for the user programs to cause the actual firmware to crash. In the worst case, the user program alone is aborted with an error code stored in the object directory.

### 10.2 Available computing time

A user program receives computing time in a 1-ms cycle (see also the following diagram). Because the firmware loses computing time due to interrupts and system functions, only about 30% - 50% of this time is available to the user program (depending on the operating mode and application case). During this time, the user program must have completed its operations and must either have closed or have yielded the computing time with the `yield()` function. In the first case, the user program is started again when the next 1-ms cycle begins; in the second case, the program is continued at the command following the `yield()` in the next 1-ms cycle.

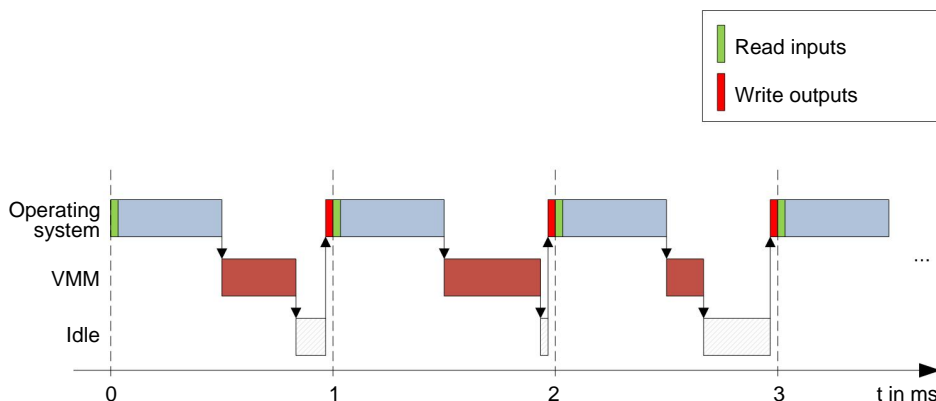

If the system detects that the user program requires more than the time assigned to it, it is closed and an error code is entered in the object directory. When developing user programs, therefore, the runtime behavior of the program must be carefully checked, especially in the case of time-intensive tasks. Therefore, it is advisable to use tables, instead of calculating a sinus value from a `sin` function.

#### Note

If the NanoJ program should not return the computing time for an excessive time, it is ended by the operating system. In this case, the number "4" is entered in the status word at object **2301<sub>h</sub>** of the VMM; the number "5" (timeout) is noted in the VMM error register at object **2302<sub>h</sub>**.

### 10.3 Sandbox

#### 10.3.1 Introduction

The MPU (Memory Protection Unit) of Cortex-M3 and the Privileged Mode and User Mode are used to create a sandbox. This means that a user program running in this sandbox can only access the specially assigned memory areas and system resources. For example, the attempt to write directly to a processor IO register is acknowledged with an MPU fault and the user program is closed with the corresponding error code in the OD.

## 10.4 Loading a NanoJ program

### 10.4.1 Uploading a NanoJ program

A user program created with NanoJ Easy can be uploaded on the web interface.

1. You do this by clicking on the "NANOJ" tab and then clicking on "upload of user programs":

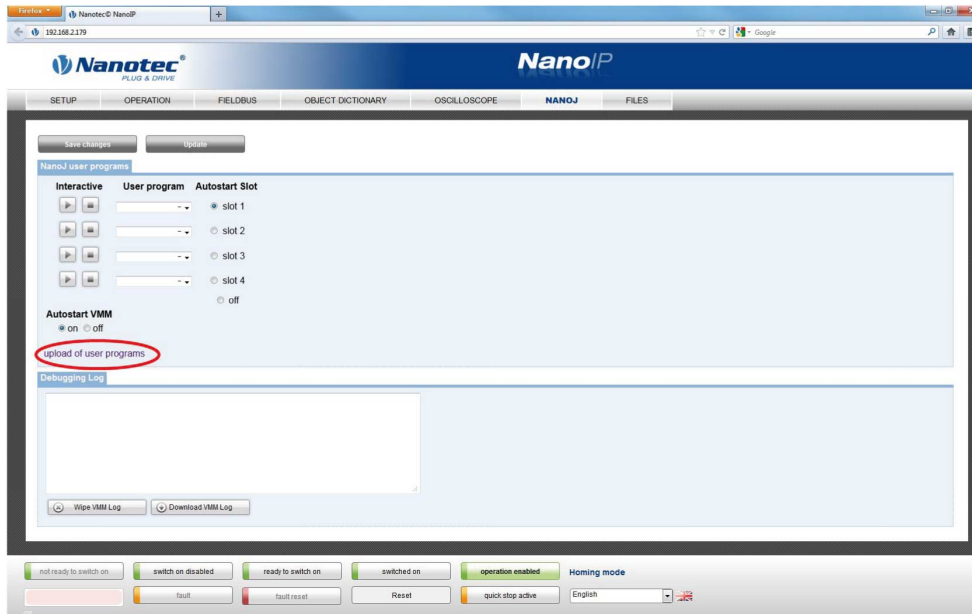

The interface then changes to the file manager.

2. Use the "Search" button to select the user program stored on the PC. It must have the extension .USR.
3. Click on "Upload". The user program is loaded into the "Config" directory.

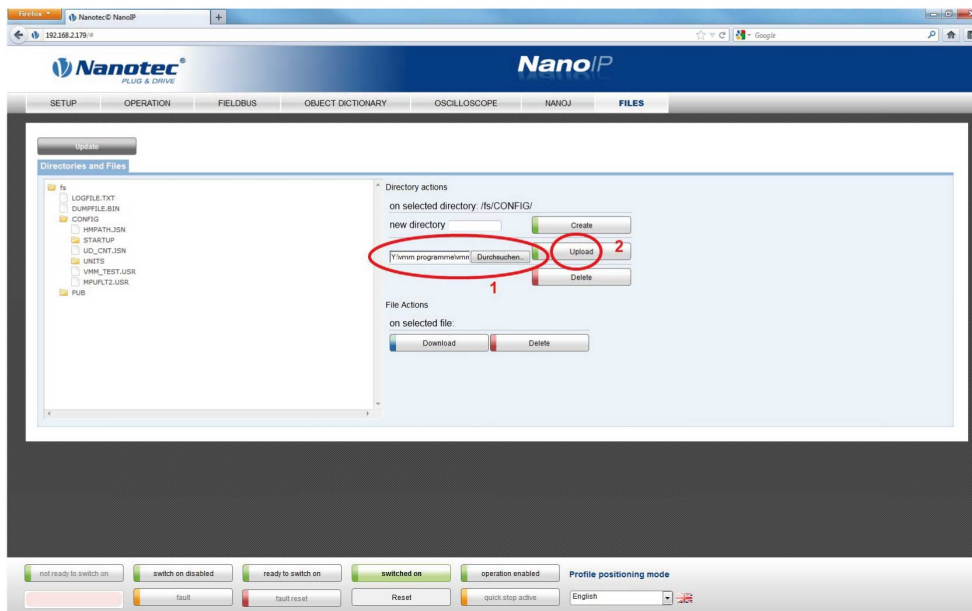

4. Switch back to the VMM control page by clicking on the "NANOJ" tab.
5. Click on "Update" and select the user program in one of the corresponding selection fields.
6. Save this change with "Save changes".

## 10.4.2 Preselection of user programs

The configuration page enables the preselection of up to 4 user programs. The desired program can be started or stopped using the play/stop buttons familiar from audio devices:

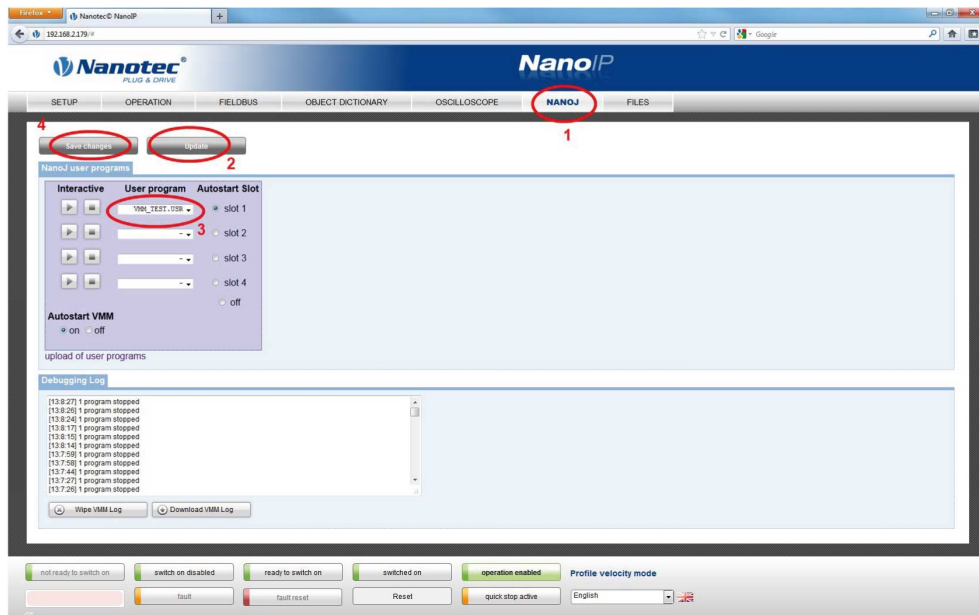

A started and running program is shown in green on the interface. If a user program causes an fault and is closed, it is highlighted in red.

If a user program is to start running automatically as soon as the motor controller is switched on, this can be set in the "Autostart Slot".

In the "Debugging Log" text field, variables and texts for debugging the program can be output by opening a special system call. See also "**System calls**".

## 10.5 Interaction of the user program with the motor controller

### 10.5.1 Communication options

A user program has numerous options for communicating with the motor controller:

- Reading and writing of OD values per PDO mapping
- Direct reading and writing of OD values via system calls
- Calling up of other system calls (e.g. write debug output)

Via a PDO mapping, OD values in the form of variables are made available to the user program. Before a user program receives its 1-ms time slot, the firmware transfer the values for this from the OD to the variables of the user program. When the user program now receives computing time, it can manipulate these variables like the usual C variables. At the end of the time slot, the new values are automatically copied into the respective OD entries by the firmware.

To optimize the performance, 3 types of mappings are defined: Input, output and input/output (In, Out, InOut). Input mappings can only be read and are not transferred back into the OD. Output mappings can only be written. Input/Output Mappings, on the other hand, permit reading and writing.

The set mappings can be read out and checked via the web interface at objects **2310<sub>h</sub>**, **2320<sub>h</sub>**, and **2330<sub>h</sub>**. For each mapping, a maximum of 16 entries is allowed.

The specification of the linker section is used to control in NanoJ Easy whether a variable is stored the under input, output, or data range.

## 10.5.2 Execution of a VMM cycle

In summary, the procedure for the execution of a VMM cycle with respect to the PDO mapping consists of the following three steps:

1. Read values from the object directory and copy them into the Inputs and Outputs areas.
2. Execute the user program.
3. Copy values from the Outputs and Inputs areas back to the object directory.

The configuration of the copy procedures is in line with the CANopen standard.

In addition, it is also possible to access system calls via the object directory. In general, this is considerably slower and therefore mappings should be given preference. However, the number of mappings is limited (16 entries each in In/Out/InOut). Therefore, it is advisable to map frequently-used and changed OD values and to access less frequently used OD entries by system call. A list of available system calls can be found in the "**System calls**" section.

### Note

It is strongly advised to access one single OD value **either** by mapping **or** system call with `od_write()`. If both are used at the same time, system call will not have any effect.

## 10.6 OD entries for controlling and configuring the VMM

### 10.6.1 OD entries

The VMM is controlled and configured by means of OD entries in the object range **2300<sub>h</sub>** to **2330<sub>h</sub>**. The web interface handles a large portion of the task, which is why it is usually not necessary for the user to directly access the entries.

OD Index	Name
<b>2300<sub>h</sub></b>	NanoJ Control
<b>2301<sub>h</sub></b>	NanoJ Status
<b>2302<sub>h</sub></b>	NanoJ Error Code
<b>2303<sub>h</sub></b>	Number Of Active User Program
<b>2304<sub>h</sub></b>	Table of available user programs
<b>2310<sub>h</sub></b>	NanoJ Input Data Selection
<b>2320<sub>h</sub></b>	NanoJ Output Data Selection
<b>2330<sub>h</sub></b>	NanoJ In/output Data Selection

### 10.6.2 Example

To select and start the "TEST1.USR" user program, the following sequence can be used for instance:

- Upload the program file into the "config" directory via the Ethernet connection
- Copy the compiled file via USB
- Write the value "54453554<sub>h</sub>" in object **2304<sub>h</sub>:01<sub>h</sub>**.
- Write the value "31000000<sub>h</sub>" in object **2304<sub>h</sub>:02<sub>h</sub>**.
- Write the value "1<sub>h</sub>" in object **2303<sub>h</sub>**.
- Check the entry **2302<sub>h</sub>** for error codes.
- If no error:

Launch the program by writing object **2300<sub>h</sub>**, bit 0 = "1".

- Check the entry **2302<sub>h</sub>** for error codes and the object **2301<sub>h</sub>**, bit 0 = "1".

To stop a running program: Write the bit 0-value = "0" to the entry **2300<sub>h</sub>**.

## 10.7 NanoJ Easy V2

### 10.7.1 Installation and use

#### Introduction

As an alternative to NanoIP, a user program can also be programmed, uploaded, and controlled with the NanoJ Easy V2 software.

#### Installation

Proceed as follows for installation:

1. Unpack "NanoJEasyV2.zip" into a directory of your choice.
2. Launch the program with the file "NanoJEasy.exe".

#### Use

For all of the following actions, it is important that the IP address of the target motor controller is known. The IP address must be entered in the header line of NanoJ Easy V2, as shown in the following figure.

Before uploading the program, it is also necessary to select a slot on the target motor controller in which the user program is to run.

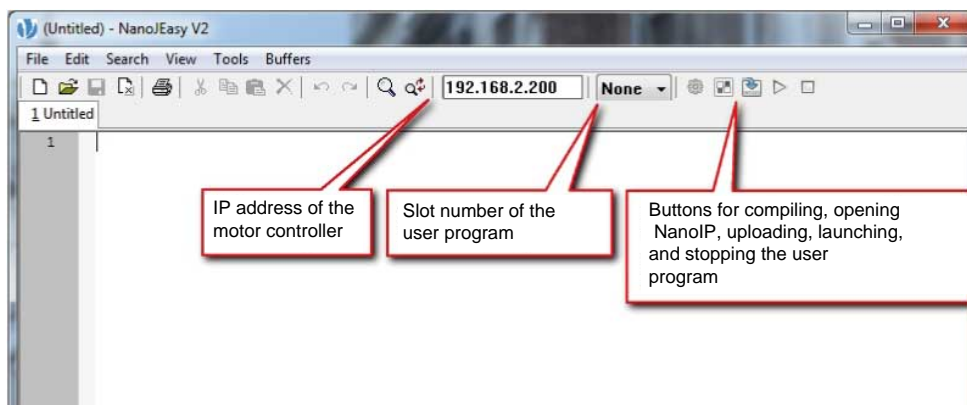

### 10.7.2 Programming of user programs

#### User program structure

A user program consists of at least two instructions:

1. The `#include "wrapper.h"` preprocessor instruction
2. The `void user(){}` function

The code to be executed can then be stored in the `void user()` function.

The file names of the user programs must not be longer than eight characters and contains three characters in the extension; for example, "main.cpp" is admissible while "alongerfilename.cpp" is not.

#### Example

Programming a square wave signal in the object `2500h:01h`

1. Copy the following text to the NanoJ Easy editor and store this file under the name "main.cpp".

```
// file main.cpp
map S32 outputReg1 as inout 0x2500:1

#include "wrapper.h"
```

```
// user program
void user() {
  U16 counter = 0;
  while( 1 ) {
    ++counter;
    if( counter < 100 )
      InOut.outputReg1 = 0;
    else if( counter < 200 )
      InOut.outputReg1 = 1;
    else
      counter = 0;
    // yield() 5 times (delay 5ms)
    for(U08 i = 0; i < 5; ++i )
      yield();
  }
} // eof
```

2. When the program has been properly translated:

Select any slot as the target slot.

3. Load the program onto the motor controller with the "Upload User Program" button.



The output if the transmission was successful is as follows:

```
mapvars v0.91 Mapping files successfully created. processing 0 Inputs:
processing 0 Outputs: processing 1 In-/Outputs: 25000120 done >Exit
code: 0
```

If the IP address of your motor controller differs from the address in the header of NanoJ Easy, the following message is output after some time:

```
connect to server: Connection timed out (10060)
!!! Connection Error !!!
```

4. In this case, check whether the IP address is correct and that you have access to the motor controller via the Ethernet. You can use the "start NanoIP" function as an aid by clicking on the button.



This starts the standard Internet browser of the computer and the homepage of the entered IP address is opened.

If NanoIP is not displayed, this may have the following causes:

- The IP address is incorrect,
- the motor controller is not connected to Ethernet,
- the computer can not access the motor controller,
- the motor controller is possibly not energized.

5. After successful upload: Launch the user program with the "start" button.



6. End the user program with the "stop" button.





### 10.7.3 Structure of a mapping

#### Introduction

This method can be used to directly link a variable in the NanoJ program with an entry in the object directory. The mapping must be created at the beginning of the file - before the `#include "wrapper.h"` instruction. Only a comment above the mapping is allowed.

**Tip** Use mapping if you frequently need access to an object in the object directory, such as the control word `6040h` or status word `6041h`.

The `od_write()` and `od_read()` functions are better suited for single access to objects (see the "**Access to the object directory**" section).

#### Declaration of the mapping

The declaration of the mapping is structured as follows:

```
map <TYPE> <NAME> as <input|output|inout> <INDEX>:<SUBINDEX>
```

The following applies:

- <TYPE>  
The data type of the variable, i.e. U32, U16, U08, S32, S16 or S08.
- <NAME>  
The name of the variable that is later used in the user program.
- <input|output|inout>  
The write and read authorization of a variable: A variable can either be declared as input, output, or inout. This defines whether a variable is readable (input), writable (output) or both (inout) and the structure by which it needs to be addressed in the program.
- <INDEX>:<SUBINDEX>  
Index and subindex of the object being mapped in the object directory.

Every declared variable is addressed in the user program via one of the three structures "In", "Out", or "InOut", depending on the defined write and read direction.

#### Example of a mapping

Example of a mapping and the associated variable access methods:

```
map U16 controlWord as output 0x6040:00
map U08 statusWord as input 0x6041:00
map U08 modeOfOperation as inout 0x6060:00

#include "wrapper.h"
void user() {
    [...]
    Out.controlWord = 1;
    U08 tmpVar = In.statusword;
    InOut.modeOfOperation = tmpVar; [...]
}
```

### Potential error source

A potential source of error is a write access by means of the `od_write()` function on an object in the object directory that was also created as a mapping. The code shown below is **faulty**:

```
map U16 controlWord as output 0x6040:00
#include " wrapper.h"
void user() {
  [...]
  Out.controlWord = 1;
  [...]
  // the value is overwritten by the mapping
  od_write(0x6040, 0x00, 5 );
  [...]
}
```

The line with the command `od_write(0x6040, 0x00, 5 );` is without effect. As described in the introduction, all mappings are copied into the object directory at the end of each millisecond.

The following procedure is therefore derived:

- The function `od_write` writes the value "5" in object **6040<sub>h</sub>:00<sub>h</sub>**.
- At the end of the 1-ms cycle, the mapping is written that also specifies object **6040<sub>h</sub>:00<sub>h</sub>**, though with the value "1".
- This means - from the user's perspective - the `od_write` command is without effect.

## 10.8 System calls

### 10.8.1 Introduction

With system calls, it is possible to call up functions integrated in the firmware directly in a user program. Because a direct code execution is only possible in the protected area of the sandbox, this is implemented via so-called Cortex-Supervisor-Calls (Svc Calls). An interrupt is triggered when the function is called and the firmware thus has the possibility of temporarily allowing a code execution outside of the sandbox. Developers of user programs do not need to worry about this mechanism. For them, the system calls can be called up like normal C functions. Only the "wrapper.h" file must be integrated as usual.

### 10.8.2 Access to the object directory

- void **od\_write**(U32 index, U32 subindex, U32 value)

This function writes the transferred value to the specified point in the object directory.

index	Index of the object being written in the object directory
subindex	Subindex of the object being written in the object directory
value	Value to be written

#### Note

It is strongly advised, to generate processor time with `yield()` after a `od_write()` has been called up. The value is immediately written to the OD. However, to enable the firmware to trigger dependent actions, it must receive computing time and therefore the user program must have been ended or stopped with `yield()`.

- void **od\_read**(U32 index, U32 subindex)

This function reads the value at the specified point in the object directory and returns it.

index	Index of the object being read in the object directory
subindex	Subindex of the object being read in the object directory

Return value	Content of the OD entry
--------------	-------------------------

#### Note

Active waiting for a value in the object directory should always be associated with a `yield()`.

#### Example:

```
while (od_read(2400,2) != 0) // wait until 2400:2 is set
    yield();
```

### 10.8.3 Process control

- void **yield()**

This function returns the process time to the operating system. The program is resumed in the next time slot at the same location.

- void **sleep**(U32 ms)

This function returns the process time to the operating system for the specified number of milliseconds. The user program is then continued at the location following the call.

ms	Wait time in milliseconds
----	---------------------------

### 10.8.4 Debug output

The following functions output a value in the debug console. They differ only in the data type of the parameter being output.

- bool **VmmDebugOutputString**(const char \*outstring)
- bool **VmmDebugOutputInt**(const U32 val)
- bool **VmmDebugOutputByte**(const U08 val)
- bool **VmmDebugOutputHalfWord**(const U16 val)
- bool **VmmDebugOutputWord**(const U32 val)
- bool **VmmDebugOutputFloat**(const Woat val)

#### Note

The debug outputs are first written to a separate area of the OD and are read out from there by the web interface. This OD entry has the index **2600<sub>h</sub>** and is 64 characters long. The subindex 0 always contains the number of characters already written.

If the buffer is full, `VmmDebugOutputxxx()` initially fails; execution of the user program is discontinued and it stops at the location of the debug output. The program is not resumed until the web interface has read out the buffer and reset the subindex 0; `VmmDebugOutputxxx()` returns to the user program.

Debug outputs therefore may only be used during the test phase in the development of a user program.

## 11 Object directory description

### 11.1 Overview

You can find a description of objects in this section of the manual.

Here you will find information on the following:

- Functions
- Object descriptions ("Index")
- Value descriptions ("Subindices")
- Descriptions of bits
- Description of the object

### 11.2 Structure of the object description

The description of object entries is always structured the same and normally consists of the following sections:

#### Function

This section briefly describes the function of the object directory.

#### Object description

This table gives detailed information on the data type, specified values, and suchlike. A detailed description can be found in the "**Object description**" section.

#### Value description

This table is only available for the "Array" or "Record" data type and gives detailed information on the subentries. A more detailed description of entries can be found in the "**Value description**" section.

#### Description

More precise information on the single bits in an entry is given here or any compositions are explained. A detailed description can be found in the "**Description**" section.

### 11.3 Object description

The object description consists of a table that contains the following entries:

#### Index

Designates the index of the object in hexadecimal notation.

#### Object Name

The name of the object.

#### Object Code

The type of object. This can be one of the following entries:

- VARIABLE: In this case the object consists of only one variable that is indexed with subindex 0.
- ARRAY: This objects always consist of one subindex 0 – which specifies the quantity of valid subentries – and the subentries themselves from index 1. The data type in an array never changes, which means that subentry 1 and all following entries always have the same data type.
- RECORD: These objects always consist of one subentry with subindex 0 – which specifies the quantity of valid subentries – and the subentries themselves from index 1. As opposed to

an ARRAY, the data type of subentries may vary, meaning, for example, that subentry 1 may have a different data type than subentry 2.

- **VISIBLE\_STRING**: The object specifies a character string encoded in ASCII. These character strings are **not** terminated by a zero string.

#### Data type

The size and interpretation of the object are specified here. The following notation applies for the "VARIABLE" object code:

- Distinction is drawn between entries that are signed; this is designated with the prefix "SIGNED". The prefix "UNSIGNED" is used for unsigned entries.
- The size of the variable in bits is added to the prefix and can be either 8, 16 or 32.

#### Savable

Designates if a object can be saved and - if so - in which category

#### Firmware Version

The firmware version of the first occurrence of the object is entered here.

#### Change history (ChangeLog)

Any changes to the object are noted here.

Additionally, there are the following table entries for the "VARIABLE" data type:

#### Access

The access restriction is entered here. The following restrictions are available:

- "Read/write": The object can be read and written
- "Read only": The object can only be read from the object directory. It is not possible to set a value.

#### PDO Mapping

Some bus systems, such as CANopen or EtherCAT, support PDO mapping. This table entry specifies whether the object may be inserted in a mapping, and in which. The following designations are possible:

- "no": The object may not be entered in any mapping.
- "TX-PDO": The object may in be entered in a RX mapping.
- "RX-PDO": The object may in be entered in a TX mapping.

#### Admissible Values

In some cases, it is only permitted to write specific values into the object. When this is the case, these values are listed here. The field remains empty when there is no restriction.

#### Specified Value

Some objects must be preassigned with values to bring the motor controller into a safe state at switch on. The value written into the object for the motor controller start is noted in this table entry.

## 11.4 Value description

### Note

For reasons of clarity, some subentries have been summarized here when all the entries have the same name.

All data for subentries with subindex 1 or higher are listed in the table with the heading "Value description". The table contains the following entries:

**Subindex**

Number of the currently specified subentry.

**Name**

The name of the subentry.

**Data type**

The size and interpretation of the subentry are specified here. The following notation always applies:

- Distinction is drawn between entries that are signed; this is designated with the prefix "SIGNED". The prefix "UNSIGNED" is used for unsigned entries.
- The size of the variable in bits is added to the prefix and can be either 8, 16 or 32.

**Access**

The access restriction for the subentry is entered here. The following restrictions are available:

- "Read/write": The object can be read and written
- "Read only": The object can only be read from the object directory. It is not possible to set a value.

**PDO Mapping**

Some bus systems, such as CANopen or EtherCAT, support PDO mapping. This table entry specifies whether the subentry may be inserted in a mapping, and in which. The following designations are possible:

- "no": The object may not be entered in any mapping.
- "TX-PDO": The object may in be entered in a RX mapping.
- "RX-PDO": The object may in be entered in a TX mapping.

**Admissible Values**

In some cases, it is only permitted to write specific values into the subentry. When this is the case, these values are listed here. The field remains empty when there is no restriction.

**Specified Value**

Some objects must be preassigned with subentries to bring the motor controller into a safe state at switch on. The value written into the subentry for the motor controller start is noted in this table entry.

**11.5 Description**

This section can be available when use requires additional information. When single bits of an object or subentry have a different meaning, diagrams are used as shown in the following example.

**Example:** The object is 8-bits large, bit 0 and 1 separately have one function. Bits 2 and 3 have been combined into one function, the same applies for bits 4 to 7.

7	6	5	4	3	2	1	0
Example [4]				Example [2]		B	A

**Example [4]**

Description of bits 4 to including 7, these bits logically belong together. The 4 in square brackets specifies the number of associated bits. A list of possible values and their description is frequently attached at this position.

### Example [2]

Description of bits 3 and 2, these bits logically belong together. The 2 in square brackets specifies the number of associated bits.

- Value 00<sub>b</sub>: The description at this position applies when bit 2 and bit 3 are at "0".
- Value 01<sub>b</sub>: The description at this position applies when bit 2 is at "0" and bit 3 at "1".
- Value 10<sub>b</sub>: The description at this position applies when bit 2 is at "1" and bit 3 at "0".
- Value 11<sub>b</sub>: The description at this position applies when bit 2 and bit 3 are at "1".

### B

Description of bit B, there is no length information for a single bit.

### A

Description of bit A, bits with a gray background remain unused.

## 1000h Device Type

### Function

Describes the motor controller type.

### Object description

Index	1000 <sub>h</sub>
Object Name	Device Type
Object Code	VARIABLE
Data type	UNSIGNED32
Savable	No
Access	Read only
PDO Mapping	No
Admissible Values	
Specified Value	00040192 <sub>h</sub>
Firmware Version	FIR-v1426
Change History	

### Description

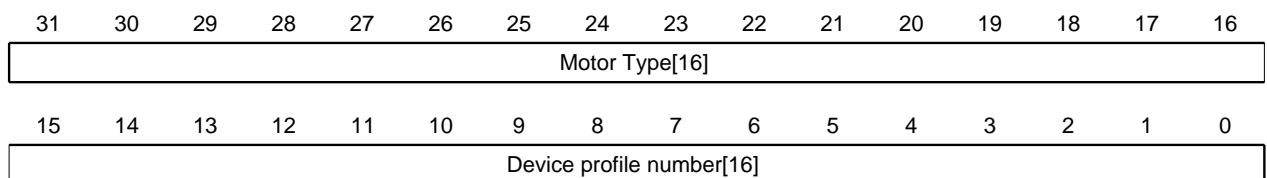

### Motor Type[16]

Describes the supported motor type.

### Device profile number[16]

Describes the supported CANopen standard.

Values:

0129<sub>h</sub> (specified value): The DS402 standard is supported.

## 1001h Error Register

### Function

Error register: In the event of an error, the corresponding error bit is set. It is automatically deleted when the error no longer exists.

### Object description

Index	1001 <sub>h</sub>
Object Name	Error Register
Object Code	VARIABLE
Data type	UNSIGNED8
Savable	No
Access	Read only
PDO Mapping	TX - PDO
Admissible Values	
Specified Value	00 <sub>h</sub>
Firmware Version	FIR-v1426
Change History	

### Description

7	6	5	4	3	2	1	0
RES	RES	PROF	COM	TEMP	VOL	CUR	GEN

#### GEN

General error

#### CUR

Current

#### VOL

Voltage

#### TEMP

Temperature

#### COM

Communication

#### PROF

Pertains to the device profile

#### RES

Reserved, always "0"

## 1003h Pre-defined Error Field

### Function

This object contains an error stack with up to eight entries.



### Object description

Index	1003 <sub>h</sub>
Object Name	Pre-defined Error Field
Object Code	ARRAY
Data type	UNSIGNED32
Savable	No
Firmware Version	FIR-v1426
Change History	Amount of subentries has changed from 2 to 9

### Value description

Subindex	00 <sub>h</sub>
Name	Number Of Errors
Data type	UNSIGNED8
Access	Read/write
PDO Mapping	No
Admissible Values	
Specified Value	00 <sub>h</sub>
Subindex	01 <sub>h</sub>
Name	Standard Error Field
Data type	UNSIGNED32
Access	Read only
PDO Mapping	No
Admissible Values	
Specified Value	00000000 <sub>h</sub>
Subindex	02 <sub>h</sub>
Name	Standard Error Field
Data type	UNSIGNED32
Access	Read only
PDO Mapping	No
Admissible Values	
Specified Value	00000000 <sub>h</sub>
Subindex	03 <sub>h</sub>
Name	Standard Error Field
Data type	UNSIGNED32
Access	Read only
PDO Mapping	No
Admissible Values	
Specified Value	00000000 <sub>h</sub>
Subindex	04 <sub>h</sub>
Name	Standard Error Field
Data type	UNSIGNED32
Access	Read only
PDO Mapping	No

Admissible Values	
Specified Value	00000000 <sub>h</sub>
Subindex 05 <sub>h</sub>	
Name	Standard Error Field
Data type	UNSIGNED32
Access	Read only
PDO Mapping	No
Admissible Values	
Specified Value	00000000 <sub>h</sub>
Subindex 06 <sub>h</sub>	
Name	Standard Error Field
Data type	UNSIGNED32
Access	Read only
PDO Mapping	No
Admissible Values	
Specified Value	00000000 <sub>h</sub>
Subindex 07 <sub>h</sub>	
Name	Standard Error Field
Data type	UNSIGNED32
Access	Read only
PDO Mapping	No
Admissible Values	
Specified Value	00000000 <sub>h</sub>
Subindex 08 <sub>h</sub>	
Name	Standard Error Field
Data type	UNSIGNED32
Access	Read only
PDO Mapping	No
Admissible Values	
Specified Value	00000000 <sub>h</sub>

## Description

### General operation

If a new error occurs, it is entered in subindex 1. The existing entries in the subindices 1 to 7 are shifted back by one. The error at subindex 7 is removed.

The number of errors that have occurred can be read from the object with subindex 0. When a "0" is written into this object, counting starts anew.

### Bit description

31	30	29	28	27	26	25	24	23	22	21	20	19	18	17	16
Error Number [8]								Error Class[8]							
15	14	13	12	11	10	9	8	7	6	5	4	3	2	1	0
Error Code[16]															

### Error Number [8]

This allows the reason for the error to be fully narrowed down. The meaning of the number can be found in the following table.

Error number	Description
1	Input voltage too high
2	Output current too high
3	Input voltage too low
4	Field bus error
5	Motor rotating in wrong direction – despite activated block
6	CANopen only: NMT master is taking too long to send Nodeguarding request
7	Encoder error due to electrical fault or faulty hardware
8	Encoder error; index not found during auto setup
9	Error in AB track
10	Positive limit switch and tolerance zone overwritten
11	Negative limit switch and tolerance zone overwritten
12	Device temperature above 80 °C
13	The values of object <b>6065<sub>h</sub></b> (Following Error Window) and object <b>6066<sub>h</sub></b> (Following Error Time Out) have been exceeded, and a fault has been output. This fault must be activated with bit 7 in object <b>3202<sub>h</sub></b> .
14	Non-volatile storage full, restart of controller for cleanup necessary
15	Motor blocked
16	Non-volatile storage corrupted, restart of controller for cleanup necessary
17	Slave needed too much time for sending PDO-tickets
18	Hall Sensor faulty

### Error Class[8]

This byte is identical to object **1001<sub>h</sub>**

### Error Code[16]

The meaning of the two bytes can be seen in the following table.

Error Code	Description
1000 <sub>h</sub>	General error
2300 <sub>h</sub>	Current at output of motor controller too high
3100 <sub>h</sub>	Overvoltage/undervoltage at motor controller input
3100 <sub>h</sub>	Undervoltage at input of motor controller
4200 <sub>h</sub>	Temperature error in motor controller
7121	Motor blocked
7305 <sub>h</sub>	Incremental or hall sensor faulty
7600 <sub>h</sub>	Flash storage full or corrupted
8000 <sub>h</sub>	Field bus error
8130 <sub>h</sub>	Only CANopen: Life guard error or heartbeat - error
8200 <sub>h</sub>	Slave needed too much time for sending a pdo message
8611 <sub>h</sub>	Position monitoring error: following error
8612 <sub>h</sub>	Position monitoring error: Reference limit hit and entered forbidden area

## 1005h COB-ID Sync

### Function

It defines the CobId of the SYNC message for the SYNC protocol. The value must correspond to a 11-bit-long CobID and only becomes valid when the CANopen stack is reset.

This object is only present in device variants with a CANopen connection.

### Object description

Index	1005 <sub>h</sub>
Object Name	COB-ID Sync
Object Code	VARIABLE
Data type	UNSIGNED32
Savable	yes, category: communication
Access	Read/write
PDO Mapping	No
Admissible Values	
Specified Value	00000080 <sub>h</sub>
Firmware Version	FIR-v1426
Change History	

## 1007h Synchronous Window Length

### Function

This object contains the length of the time window in microseconds for synchronous PDOs.

The value 0 switches of the time window, the PDOs can therefore be sent at any time.

This object is only present in device variants with a CANopen connection.

### Object description

Index	1007 <sub>h</sub>
Object Name	Synchronous Window Length
Object Code	VARIABLE
Data type	UNSIGNED32
Savable	yes, category: communication
Access	Read/write
PDO Mapping	No
Admissible Values	
Specified Value	00000000 <sub>h</sub>
Firmware Version	FIR-v1426
Change History	

## 1008h Manufacturer Device Name

### Function

Contains the device name as a string.

### Object description

Index	1008 <sub>h</sub>
Object Name	Manufacturer Device Name
Object Code	VARIABLE
Data type	VISIBLE_STRING
Savable	No
Access	Read only
PDO Mapping	No
Admissible Values	
Specified Value	
Firmware Version	FIR-v1426
Change History	

### Description

The length of the string appears in subindex 0 of this object. The individual characters are contained as of subindex 1. The character string is not terminated by a zero string.

## 1009h Manufacturer Hardware Version

### Function

This object contains the hardware version as a string.

### Object description

Index	1009 <sub>h</sub>
Object Name	Manufacturer Hardware Version
Object Code	VARIABLE
Data type	VISIBLE_STRING
Savable	No
Access	Read only
PDO Mapping	No
Admissible Values	
Specified Value	
Firmware Version	FIR-v1426
Change History	

### Description

The length of the string appears in subindex 0 of this object. The individual characters are contained as of subindex 1. The character string is not terminated by a zero string.

## 100Ah Manufacturer Software Version

### Function

This object contains the software version as a string.

### Object description

Index	100A <sub>h</sub>
Object Name	Manufacturer Software Version

Object Code	VARIABLE
Data type	VISIBLE_STRING
Savable	No
Access	Read only
PDO Mapping	No
Admissible Values	
Specified Value	FIR-v1504-B92112
Firmware Version	FIR-v1426
Change History	

### Description

The length of the string appears in subindex 0 of this object. The individual characters are contained as of subindex 1. The character string is not terminated by a zero string.

## 100Ch Guard Time

### Function

This object is a time in milliseconds that is multiplied by object **100D<sub>h</sub>** to yield the specified value for "node guarding" of the "Network Management" CANopen service.

This object is only present in device variants with a CANopen connection.

### Object description

Index	100C <sub>h</sub>
Object Name	Guard Time
Object Code	VARIABLE
Data type	UNSIGNED16
Savable	yes, category: communication
Access	Read/write
PDO Mapping	No
Admissible Values	
Specified Value	0000 <sub>h</sub>
Firmware Version	FIR-v1426
Change History	

## 100Dh Live Time Factor

### Function

This object is a multiplier that is multiplied by object **100C<sub>h</sub>** to yield the time window for the "node guarding" protocol in milliseconds.

This object is only present in device variants with a CANopen connection.

### Object description

Index	100D <sub>h</sub>
Object Name	Live Time Factor
Object Code	VARIABLE
Data type	UNSIGNED8
Savable	yes, category: communication

---

Access	Read/write
PDO Mapping	No
Admissible Values	
Specified Value	00 <sub>h</sub>
Firmware Version	FIR-v1426
Change History	

---

## 1010h Store Parameters

### Function

With this object the saving procedure can be started.

### Object description

---

Index	1010 <sub>h</sub>
Object Name	Store Parameters
Object Code	ARRAY
Data type	UNSIGNED32
Savable	No
Firmware Version	FIR-v1426
Change History	Firmware Version FIR-v1436: Entry "Object Name" modified from "Store Parameter" to "Store Parameters".  Firmware Version FIR-v1436: Amount of subentries has changed from 3 to 4.

---

### Value description

---

Subindex	00 <sub>h</sub>
Name	Highest Sub-index Supported
Data type	UNSIGNED8
Access	Read only
PDO Mapping	No
Admissible Values	
Specified Value	03 <sub>h</sub>

---

Subindex	01 <sub>h</sub>
Name	Save All The Parameters To Non-volatile Memory
Data type	UNSIGNED32
Access	Read/write
PDO Mapping	No
Admissible Values	
Specified Value	00000001 <sub>h</sub>

---

Subindex	02 <sub>h</sub>
Name	Save The Comm Parameters To Non-volatile Memory
Data type	UNSIGNED32
Access	Read/write
PDO Mapping	No
Admissible Values	

---

Specified Value	00000001 <sub>h</sub>
Subindex	03 <sub>h</sub>
Name	Save The Application Parameters To Non-volatile Memory
Data type	UNSIGNED32
Access	Read/write
PDO Mapping	No
Admissible Values	
Specified Value	00000001 <sub>h</sub>

### Description

To start the saving procedure the value 65766173<sub>h</sub> has to be written to subindex 1 or 2. This accords to the decimal value 1702257011<sub>d</sub> respectively the ASCII string "save".

## 1011h Restore Default Parameters

### Function

This object can be used to reset the entire object directory to the default values.

### Object description

Index	1011 <sub>h</sub>
Object Name	Restore Default Parameters
Object Code	ARRAY
Data type	UNSIGNED32
Savable	No
Firmware Version	FIR-v1426
Change History	Firmware Version FIR-v1436: Entry "Object Name" modified from "Restore Default Parameter" to "Restore Default Parameters". Firmware Version FIR-v1436: Amount of subentries has changed from 2 to 4.

### Value description

Subindex	00 <sub>h</sub>
Name	Highest Sub-index Supported
Data type	UNSIGNED8
Access	Read only
PDO Mapping	No
Admissible Values	
Specified Value	03 <sub>h</sub>
Subindex	01 <sub>h</sub>
Name	Restore All Default Parameters
Data type	UNSIGNED32
Access	Read/write
PDO Mapping	No
Admissible Values	
Specified Value	00000000 <sub>h</sub>



Subindex	02 <sub>h</sub>
Name	Restore The Comm Default Parameters
Data type	UNSIGNED32
Access	Read/write
PDO Mapping	No
Admissible Values	
Specified Value	00000000 <sub>h</sub>
Subindex	03 <sub>h</sub>
Name	Restore The Application Default Parameters
Data type	UNSIGNED32
Access	Read/write
PDO Mapping	No
Admissible Values	
Specified Value	00000000 <sub>h</sub>

### Description

When value 64616F6C<sub>h</sub> (or 1684107116<sub>d</sub> or "load" in ASCII) is written into this object, the entire object directory or parts of it will get reset to the default values. The used subindex determines the area, that will get resetted:

- Subindex 01<sub>h</sub>: Resets the object dictionary completely (this is up to subindex 02<sub>h</sub> and 03<sub>h</sub>).

#### Note

Using this all communication parameter will get deleted.

- Subindex 02<sub>h</sub>: Resets all objects belonging to the category "communication".
- Subindex 03<sub>h</sub>: Resets all objects belonging to the category "application".

Subindex 03<sub>h</sub>: Setzt die Objekteinträge zurück, die zur Kategorie "Applikationsdaten" gehören.

#### Note

For the reset to take effect, the motor controller reboots at the end.

## 1014h COB-ID EMCY

### Function

This object describes CobId of "Emergency Service" under CANopen.

### Object description

Index	1014 <sub>h</sub>
Object Name	COB-ID EMCY
Object Code	VARIABLE
Data type	UNSIGNED32
Savable	yes, category: communication
Access	Read only
PDO Mapping	No
Admissible Values	
Specified Value	00000000 <sub>h</sub>
Firmware Version	FIR-v1426
Change History	

## 1017h Producer Heartbeat Time

### Function

This object specifies the heartbeat time of the CANopen services network management in milliseconds. No heartbeat message is sent when the object is set to the value 0.

This object is only present in device variants with a CANopen connection.

### Object description

Index	1017 <sub>h</sub>
Object Name	Producer Heartbeat Time
Object Code	VARIABLE
Data type	UNSIGNED16
Savable	yes, category: communication
Access	Read/write
PDO Mapping	No
Admissible Values	
Specified Value	0000 <sub>h</sub>
Firmware Version	FIR-v1426
Change History	Version FIR-v1422-B36464: Name entry changed from "Producer heartbeat time" to "Producer Heartbeat Time"

## 1018h Identity Object

### Function

The object contains information on the manufacturer, the product code and the revision and serial numbers.

### Object description

Index	1018 <sub>h</sub>
Object Name	Identity Object
Object Code	RECORD
Data type	IDENTITY
Savable	No
Firmware Version	FIR-v1426
Change History	

### Value description

Subindex	00 <sub>h</sub>
Name	Highest Sub-index Supported
Data type	UNSIGNED8
Access	Read only
PDO Mapping	No
Admissible Values	
Specified Value	04 <sub>h</sub>
Subindex	01 <sub>h</sub>

Name	Vendor-ID
Data type	UNSIGNED32
Access	Read only
PDO Mapping	No
Admissible Values	
Specified Value	0000026C <sub>h</sub>
Subindex	02 <sub>h</sub>
Name	Product Code
Data type	UNSIGNED32
Access	Read only
PDO Mapping	No
Admissible Values	
Specified Value	00000002 <sub>h</sub>
Subindex	03 <sub>h</sub>
Name	Revision Number
Data type	UNSIGNED32
Access	Read only
PDO Mapping	No
Admissible Values	
Specified Value	00000001 <sub>h</sub>
Subindex	04 <sub>h</sub>
Name	Serial Number
Data type	UNSIGNED32
Access	Read only
PDO Mapping	No
Admissible Values	
Specified Value	00000001 <sub>h</sub>

## 1400h Receive PDO 1 Communication Parameter

### Function

Contains the communication parameters for receive mapping (RX - PDO) 1.

### Object description

Index	1400 <sub>h</sub>
Object Name	Receive PDO 1 Communication Parameter
Object Code	RECORD
Data type	PDO_COMMUNICATION_PARAMETER
Savable	yes, category: communication
Firmware Version	FIR-v1426
Change History	

### Value description

Subindex	00 <sub>h</sub>
Name	Highest Sub-index Supported

Data type	UNSIGNED8
Access	Read only
PDO Mapping	No
Admissible Values	
Specified Value	02 <sub>h</sub>
Subindex	01 <sub>h</sub>
Name	COB-ID
Data type	UNSIGNED32
Access	Read/write
PDO Mapping	No
Admissible Values	
Specified Value	00000000 <sub>h</sub>
Subindex	02 <sub>h</sub>
Name	Transmission Type
Data type	UNSIGNED8
Access	Read/write
PDO Mapping	No
Admissible Values	
Specified Value	FF <sub>h</sub>

## 1401h Receive PDO 2 Communication Parameter

### Function

Contains the communication parameters for receive mapping (RX - PDO) 2.

### Object description

Index	1401 <sub>h</sub>
Object Name	Receive PDO 2 Communication Parameter
Object Code	RECORD
Data type	PDO_COMMUNICATION_PARAMETER
Savable	yes, category: communication
Firmware Version	FIR-v1426
Change History	

### Value description

Subindex	00 <sub>h</sub>
Name	Highest Sub-index Supported
Data type	UNSIGNED8
Access	Read only
PDO Mapping	No
Admissible Values	
Specified Value	02 <sub>h</sub>
Subindex	01 <sub>h</sub>
Name	COB-ID
Data type	UNSIGNED32

Access	Read/write
PDO Mapping	No
Admissible Values	
Specified Value	00000000 <sub>h</sub>
Subindex	02 <sub>h</sub>
Name	Transmission Type
Data type	UNSIGNED8
Access	Read/write
PDO Mapping	No
Admissible Values	
Specified Value	FF <sub>h</sub>

## 1402h Receive PDO 3 Communication Parameter

### Function

Contains the communication parameters for receive mapping (RX - PDO) 3.

### Object description

Index	1402 <sub>h</sub>
Object Name	Receive PDO 3 Communication Parameter
Object Code	RECORD
Data type	PDO_COMMUNICATION_PARAMETER
Savable	yes, category: communication
Firmware Version	FIR-v1426
Change History	

### Value description

Subindex	00 <sub>h</sub>
Name	Highest Sub-index Supported
Data type	UNSIGNED8
Access	Read only
PDO Mapping	No
Admissible Values	
Specified Value	02 <sub>h</sub>
Subindex	01 <sub>h</sub>
Name	COB-ID
Data type	UNSIGNED32
Access	Read/write
PDO Mapping	No
Admissible Values	
Specified Value	00000000 <sub>h</sub>
Subindex	02 <sub>h</sub>
Name	Transmission Type
Data type	UNSIGNED8
Access	Read/write

PDO Mapping	No
Admissible Values	
Specified Value	FF <sub>h</sub>

## 1403h Receive PDO 4 Communication Parameter

### Function

Contains the communication parameters for receive mapping (RX - PDO) 4.

### Object description

Index	1403 <sub>h</sub>
Object Name	Receive PDO 4 Communication Parameter
Object Code	RECORD
Data type	PDO_COMMUNICATION_PARAMETER
Savable	yes, category: communication
Firmware Version	FIR-v1426
Change History	

### Value description

Subindex	00 <sub>h</sub>
Name	Highest Sub-index Supported
Data type	UNSIGNED8
Access	Read only
PDO Mapping	No
Admissible Values	
Specified Value	02 <sub>h</sub>

Subindex	01 <sub>h</sub>
Name	COB-ID
Data type	UNSIGNED32
Access	Read/write
PDO Mapping	No
Admissible Values	
Specified Value	00000000 <sub>h</sub>

Subindex	02 <sub>h</sub>
Name	Transmission Type
Data type	UNSIGNED8
Access	Read/write
PDO Mapping	No
Admissible Values	
Specified Value	FF <sub>h</sub>

## 1600h Receive PDO 1 Mapping Parameter

### Function

This object contains an input PDO mapping of the active field bus (EtherCAT or CANopen).

### Object description

Index	1600 <sub>h</sub>
Object Name	Receive PDO 1 Mapping Parameter
Object Code	RECORD
Data type	PDO_MAPPING
Savable	yes, category: communication
Firmware Version	FIR-v1426
Change History	Firmware Version FIR-v1426: Entry "caption" modified from "1600h Drive Control" to "1600h Receive PDO 1 Mapping Parameter". Firmware Version FIR-v1426: Entry "Object Name" modified from "Drive Control" to "Receive PDO 1 Mapping Parameter".

### Value description

Subindex	00 <sub>h</sub>
Name	Highest Sub-index Supported
Data type	UNSIGNED8
Access	Read/write
PDO Mapping	No
Admissible Values	
Specified Value	03 <sub>h</sub>
Subindex	01 <sub>h</sub>
Name	1st Object To Be Mapped
Data type	UNSIGNED32
Access	Read/write
PDO Mapping	No
Admissible Values	
Specified Value	60400010 <sub>h</sub>
Subindex	02 <sub>h</sub>
Name	2nd Object To Be Mapped
Data type	UNSIGNED32
Access	Read/write
PDO Mapping	No
Admissible Values	
Specified Value	60600008 <sub>h</sub>
Subindex	03 <sub>h</sub>
Name	3rd Object To Be Mapped
Data type	UNSIGNED32
Access	Read/write
PDO Mapping	No
Admissible Values	
Specified Value	32020020 <sub>h</sub>
Subindex	04 <sub>h</sub>
Name	4th Object To Be Mapped
Data type	UNSIGNED32

Access	Read/write
PDO Mapping	No
Admissible Values	
Specified Value	00000000 <sub>h</sub>
<hr/>	
Subindex	05 <sub>h</sub>
Name	5th Object To Be Mapped
Data type	UNSIGNED32
Access	Read/write
PDO Mapping	No
Admissible Values	
Specified Value	00000000 <sub>h</sub>
<hr/>	
Subindex	06 <sub>h</sub>
Name	6th Object To Be Mapped
Data type	UNSIGNED32
Access	Read/write
PDO Mapping	No
Admissible Values	
Specified Value	00000000 <sub>h</sub>
<hr/>	
Subindex	07 <sub>h</sub>
Name	7th Object To Be Mapped
Data type	UNSIGNED32
Access	Read/write
PDO Mapping	No
Admissible Values	
Specified Value	00000000 <sub>h</sub>
<hr/>	
Subindex	08 <sub>h</sub>
Name	8th Object To Be Mapped
Data type	UNSIGNED32
Access	Read/write
PDO Mapping	No
Admissible Values	
Specified Value	00000000 <sub>h</sub>

**Description**

Each subindex (1-8) describes a mapped object.

A mapping entry consists of four bytes made up according to the following graphic.

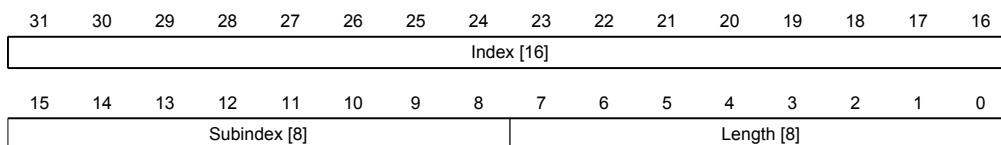

**Index [16]**

Contains the index of the object to be mapped



**Subindex [8]**

Contains the subindex of the object to be mapped

**Length [8]**

Contains the length of the object to be mapped in the bit unit.

**1601h Receive PDO 2 Mapping Parameter**

**Function**

This object contains an input PDO mapping of the active field bus (EtherCAT or CANopen).

**Object description**

---

Index	1601 <sub>h</sub>
Object Name	Receive PDO 2 Mapping Parameter
Object Code	RECORD
Data type	PDO_MAPPING
Savable	yes, category: communication
Firmware Version	FIR-v1426
Change History	Firmware Version FIR-v1426: Entry "caption" modified from "1601h Positioning Control" to "1601h Receive PDO 2 Mapping Parameter". Firmware Version FIR-v1426: Entry "Object Name" modified from "Positioning Control" to "Receive PDO 2 Mapping Parameter".

---

**Value description**

---

Subindex	00 <sub>h</sub>
Name	Highest Sub-index Supported
Data type	UNSIGNED8
Access	Read/write
PDO Mapping	No
Admissible Values	
Specified Value	02 <sub>h</sub>

---

Subindex	01 <sub>h</sub>
Name	1st Object To Be Mapped
Data type	UNSIGNED32
Access	Read/write
PDO Mapping	No
Admissible Values	
Specified Value	607A0020 <sub>h</sub>

---

Subindex	02 <sub>h</sub>
Name	2nd Object To Be Mapped
Data type	UNSIGNED32
Access	Read/write
PDO Mapping	No
Admissible Values	
Specified Value	60810020 <sub>h</sub>

---

Subindex	03 <sub>h</sub>
Name	3rd Object To Be Mapped
Data type	UNSIGNED32
Access	Read/write
PDO Mapping	No
Admissible Values	
Specified Value	00000000 <sub>h</sub>
Subindex	04 <sub>h</sub>
Name	4th Object To Be Mapped
Data type	UNSIGNED32
Access	Read/write
PDO Mapping	No
Admissible Values	
Specified Value	00000000 <sub>h</sub>
Subindex	05 <sub>h</sub>
Name	5th Object To Be Mapped
Data type	UNSIGNED32
Access	Read/write
PDO Mapping	No
Admissible Values	
Specified Value	00000000 <sub>h</sub>
Subindex	06 <sub>h</sub>
Name	6th Object To Be Mapped
Data type	UNSIGNED32
Access	Read/write
PDO Mapping	No
Admissible Values	
Specified Value	00000000 <sub>h</sub>
Subindex	07 <sub>h</sub>
Name	7th Object To Be Mapped
Data type	UNSIGNED32
Access	Read/write
PDO Mapping	No
Admissible Values	
Specified Value	00000000 <sub>h</sub>
Subindex	08 <sub>h</sub>
Name	8th Object To Be Mapped
Data type	UNSIGNED32
Access	Read/write
PDO Mapping	No
Admissible Values	
Specified Value	00000000 <sub>h</sub>

## Description

Each subindex (1-8) describes a mapped object.

A mapping entry consists of four bytes made up according to the following graphic.

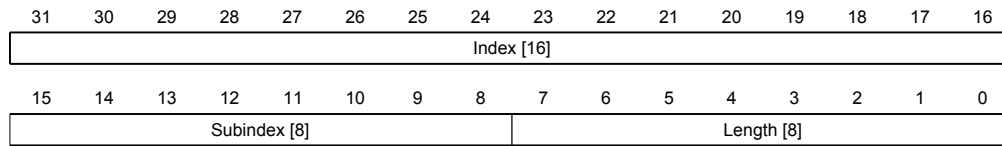

### Index [16]

Contains the index of the object to be mapped

### Subindex [8]

Contains the subindex of the object to be mapped

### Length [8]

Contains the length of the object to be mapped in the bit unit.

## 1602h Receive PDO 3 Mapping Parameter

### Function

This object contains an input PDO mapping of the active field bus (EtherCAT or CANopen).

### Object description

Index	1602 <sub>h</sub>
Object Name	Receive PDO 3 Mapping Parameter
Object Code	RECORD
Data type	PDO_MAPPING
Savable	yes, category: communication
Firmware Version	FIR-v1426
Change History	Firmware Version FIR-v1426: Entry "caption" modified from "1602h Velocity Control" to "1602h Receive PDO 3 Mapping Parameter". Firmware Version FIR-v1426: Entry "Object Name" modified from "Velocity Control" to "Receive PDO 3 Mapping Parameter".

### Value description

Subindex	00 <sub>h</sub>
Name	Highest Sub-index Supported
Data type	UNSIGNED8
Access	Read/write
PDO Mapping	No
Admissible Values	
Specified Value	01 <sub>h</sub>
Subindex	01 <sub>h</sub>
Name	1st Object To Be Mapped
Data type	UNSIGNED32
Access	Read/write

PDO Mapping	No
Admissible Values	
Specified Value	60420010 <sub>h</sub>
Subindex	02 <sub>h</sub>
Name	2nd Object To Be Mapped
Data type	UNSIGNED32
Access	Read/write
PDO Mapping	No
Admissible Values	
Specified Value	00000000 <sub>h</sub>
Subindex	03 <sub>h</sub>
Name	3rd Object To Be Mapped
Data type	UNSIGNED32
Access	Read/write
PDO Mapping	No
Admissible Values	
Specified Value	00000000 <sub>h</sub>
Subindex	04 <sub>h</sub>
Name	4th Object To Be Mapped
Data type	UNSIGNED32
Access	Read/write
PDO Mapping	No
Admissible Values	
Specified Value	00000000 <sub>h</sub>
Subindex	05 <sub>h</sub>
Name	5th Object To Be Mapped
Data type	UNSIGNED32
Access	Read/write
PDO Mapping	No
Admissible Values	
Specified Value	00000000 <sub>h</sub>
Subindex	06 <sub>h</sub>
Name	6th Object To Be Mapped
Data type	UNSIGNED32
Access	Read/write
PDO Mapping	No
Admissible Values	
Specified Value	00000000 <sub>h</sub>
Subindex	07 <sub>h</sub>
Name	7th Object To Be Mapped
Data type	UNSIGNED32
Access	Read/write
PDO Mapping	No

Admissible Values	
Specified Value	00000000 <sub>h</sub>
Subindex	08 <sub>h</sub>
Name	8th Object To Be Mapped
Data type	UNSIGNED32
Access	Read/write
PDO Mapping	No
Admissible Values	
Specified Value	00000000 <sub>h</sub>

### Description

Each subindex (1-8) describes a mapped object.

A mapping entry consists of four bytes made up according to the following graphic.

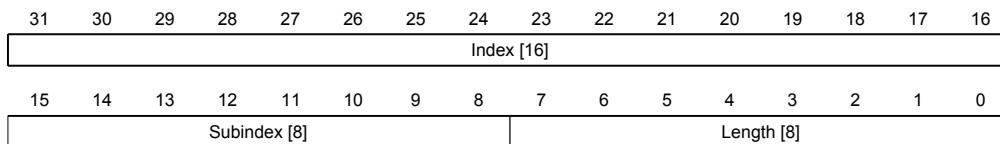

#### Index [16]

Contains the index of the object to be mapped

#### Subindex [8]

Contains the subindex of the object to be mapped

#### Length [8]

Contains the length of the object to be mapped in the bit unit.

## 1603h Receive PDO 4 Mapping Parameter

### Function

This object contains an input PDO mapping of the active field bus (EtherCAT or CANopen).

### Object description

Index	1603 <sub>h</sub>
Object Name	Receive PDO 4 Mapping Parameter
Object Code	RECORD
Data type	PDO_MAPPING
Savable	yes, category: communication
Firmware Version	FIR-v1426
Change History	Firmware Version FIR-v1426: Entry "caption" modified from "1603h Output Control" to "1603h Receive PDO 4 Mapping Parameter". Firmware Version FIR-v1426: Entry "Object Name" modified from "Output Control" to "Receive PDO 4 Mapping Parameter".

### Value description

Subindex	00 <sub>h</sub>
----------	-----------------

Name	Highest Sub-index Supported
Data type	UNSIGNED8
Access	Read/write
PDO Mapping	No
Admissible Values	
Specified Value	01 <sub>h</sub>
Subindex	01 <sub>h</sub>
Name	1st Object To Be Mapped
Data type	UNSIGNED32
Access	Read/write
PDO Mapping	No
Admissible Values	
Specified Value	60FE0120 <sub>h</sub>
Subindex	02 <sub>h</sub>
Name	2nd Object To Be Mapped
Data type	UNSIGNED32
Access	Read/write
PDO Mapping	No
Admissible Values	
Specified Value	00000000 <sub>h</sub>
Subindex	03 <sub>h</sub>
Name	3rd Object To Be Mapped
Data type	UNSIGNED32
Access	Read/write
PDO Mapping	No
Admissible Values	
Specified Value	00000000 <sub>h</sub>
Subindex	04 <sub>h</sub>
Name	4th Object To Be Mapped
Data type	UNSIGNED32
Access	Read/write
PDO Mapping	No
Admissible Values	
Specified Value	00000000 <sub>h</sub>
Subindex	05 <sub>h</sub>
Name	5th Object To Be Mapped
Data type	UNSIGNED32
Access	Read/write
PDO Mapping	No
Admissible Values	
Specified Value	00000000 <sub>h</sub>
Subindex	06 <sub>h</sub>
Name	6th Object To Be Mapped

Data type	UNSIGNED32
Access	Read/write
PDO Mapping	No
Admissible Values	
Specified Value	00000000 <sub>h</sub>
<hr/>	
Subindex	07 <sub>h</sub>
Name	7th Object To Be Mapped
Data type	UNSIGNED32
Access	Read/write
PDO Mapping	No
Admissible Values	
Specified Value	00000000 <sub>h</sub>
<hr/>	
Subindex	08 <sub>h</sub>
Name	8th Object To Be Mapped
Data type	UNSIGNED32
Access	Read/write
PDO Mapping	No
Admissible Values	
Specified Value	00000000 <sub>h</sub>

### Description

Each subindex (1-8) describes a mapped object.

A mapping entry consists of four bytes made up according to the following graphic.

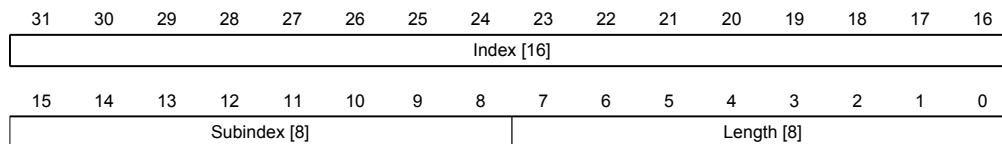

#### Index [16]

Contains the index of the object to be mapped

#### Subindex [8]

Contains the subindex of the object to be mapped

#### Length [8]

Contains the length of the object to be mapped in the bit unit.

## 1800h Transmit PDO 1 Communication Parameter

### Function

Contains the communication parameters for transmit mapping (RX - PDO) 1.

### Object description

Index	1800 <sub>h</sub>
Object Name	Transmit PDO 1 Communication Parameter
Object Code	RECORD

---

Data type	PDO_COMMUNICATION_PARAMETER
Savable	yes, category: communication
Firmware Version	FIR-v1426
Change History	

---

### Value description

---

Subindex	00 <sub>h</sub>
Name	Highest Sub-index Supported
Data type	UNSIGNED8
Access	Read only
PDO Mapping	No
Admissible Values	
Specified Value	05 <sub>h</sub>

---

Subindex	01 <sub>h</sub>
Name	COB-ID
Data type	UNSIGNED32
Access	Read/write
PDO Mapping	No
Admissible Values	
Specified Value	00000000 <sub>h</sub>

---

Subindex	02 <sub>h</sub>
Name	Transmission Type
Data type	UNSIGNED8
Access	Read/write
PDO Mapping	No
Admissible Values	
Specified Value	FF <sub>h</sub>

---

Subindex	03 <sub>h</sub>
Name	Inhibit Time
Data type	UNSIGNED16
Access	Read/write
PDO Mapping	No
Admissible Values	
Specified Value	0000 <sub>h</sub>

---

Subindex	04 <sub>h</sub>
Name	Compatibility Entry
Data type	UNSIGNED8
Access	Read/write
PDO Mapping	No
Admissible Values	
Specified Value	00 <sub>h</sub>

---

Subindex	05 <sub>h</sub>
Name	Event Timer

---



Data type	UNSIGNED16
Access	Read/write
PDO Mapping	No
Admissible Values	
Specified Value	0000 <sub>h</sub>

## 1801h Transmit PDO 2 Communication Parameter

### Function

Contains the communication parameters for transmit mapping (RX - PDO) 2.

### Object description

Index	1801 <sub>h</sub>
Object Name	Transmit PDO 2 Communication Parameter
Object Code	RECORD
Data type	PDO_COMMUNICATION_PARAMETER
Savable	yes, category: communication
Firmware Version	FIR-v1426
Change History	

### Value description

Subindex	00 <sub>h</sub>
Name	Highest Sub-index Supported
Data type	UNSIGNED8
Access	Read only
PDO Mapping	No
Admissible Values	
Specified Value	05 <sub>h</sub>

Subindex	01 <sub>h</sub>
Name	COB-ID
Data type	UNSIGNED32
Access	Read/write
PDO Mapping	No
Admissible Values	
Specified Value	00000000 <sub>h</sub>

Subindex	02 <sub>h</sub>
Name	Transmission Type
Data type	UNSIGNED8
Access	Read/write
PDO Mapping	No
Admissible Values	
Specified Value	FF <sub>h</sub>

Subindex	03 <sub>h</sub>
Name	Inhibit Time
Data type	UNSIGNED16

Access	Read/write
PDO Mapping	No
Admissible Values	
Specified Value	0000 <sub>h</sub>
Subindex	04 <sub>h</sub>
Name	Compatibility Entry
Data type	UNSIGNED8
Access	Read/write
PDO Mapping	No
Admissible Values	
Specified Value	00 <sub>h</sub>
Subindex	05 <sub>h</sub>
Name	Event Timer
Data type	UNSIGNED16
Access	Read/write
PDO Mapping	No
Admissible Values	
Specified Value	0000 <sub>h</sub>

## 1802h Transmit PDO 3 Communication Parameter

### Function

Contains the communication parameters for transmit mapping (RX - PDO) 3.

### Object description

Index	1802 <sub>h</sub>
Object Name	Transmit PDO 3 Communication Parameter
Object Code	RECORD
Data type	PDO_COMMUNICATION_PARAMETER
Savable	yes, category: communication
Firmware Version	FIR-v1426
Change History	

### Value description

Subindex	00 <sub>h</sub>
Name	Highest Sub-index Supported
Data type	UNSIGNED8
Access	Read only
PDO Mapping	No
Admissible Values	
Specified Value	05 <sub>h</sub>
Subindex	01 <sub>h</sub>
Name	COB-ID
Data type	UNSIGNED32
Access	Read/write

PDO Mapping	No
Admissible Values	
Specified Value	00000000 <sub>h</sub>
Subindex	02 <sub>h</sub>
Name	Transmission Type
Data type	UNSIGNED8
Access	Read/write
PDO Mapping	No
Admissible Values	
Specified Value	FF <sub>h</sub>
Subindex	03 <sub>h</sub>
Name	Inhibit Time
Data type	UNSIGNED16
Access	Read/write
PDO Mapping	No
Admissible Values	
Specified Value	0000 <sub>h</sub>
Subindex	04 <sub>h</sub>
Name	Compatibility Entry
Data type	UNSIGNED8
Access	Read/write
PDO Mapping	No
Admissible Values	
Specified Value	00 <sub>h</sub>
Subindex	05 <sub>h</sub>
Name	Event Timer
Data type	UNSIGNED16
Access	Read/write
PDO Mapping	No
Admissible Values	
Specified Value	0000 <sub>h</sub>

## 1803h Transmit PDO 4 Communication Parameter

### Function

Contains the communication parameters for transmit mapping (RX - PDO) 4.

### Object description

Index	1803 <sub>h</sub>
Object Name	Transmit PDO 4 Communication Parameter
Object Code	RECORD
Data type	PDO_COMMUNICATION_PARAMETER
Savable	yes, category: communication
Firmware Version	FIR-v1426

---

Change History

---

**Value description**

Subindex	00 <sub>h</sub>
Name	Highest Sub-index Supported
Data type	UNSIGNED8
Access	Read only
PDO Mapping	No
Admissible Values	
Specified Value	05 <sub>h</sub>
Subindex	01 <sub>h</sub>
Name	COB-ID
Data type	UNSIGNED32
Access	Read/write
PDO Mapping	No
Admissible Values	
Specified Value	00000000 <sub>h</sub>
Subindex	02 <sub>h</sub>
Name	Transmission Type
Data type	UNSIGNED8
Access	Read/write
PDO Mapping	No
Admissible Values	
Specified Value	FF <sub>h</sub>
Subindex	03 <sub>h</sub>
Name	Inhibit Time
Data type	UNSIGNED16
Access	Read/write
PDO Mapping	No
Admissible Values	
Specified Value	0000 <sub>h</sub>
Subindex	04 <sub>h</sub>
Name	Compatibility Entry
Data type	UNSIGNED8
Access	Read/write
PDO Mapping	No
Admissible Values	
Specified Value	00 <sub>h</sub>
Subindex	05 <sub>h</sub>
Name	Event Timer
Data type	UNSIGNED16
Access	Read/write
PDO Mapping	No

Admissible Values	
Specified Value	0000 <sub>h</sub>

## 1A00h Transmit PDO 1 Mapping Parameter

### Function

This object specifies an output PDO mapping of the active field bus (EtherCAT or CANopen).

### Object description

Index	1A00h
Object Name	Transmit PDO 1 Mapping Parameter
Object Code	RECORD
Data type	PDO_MAPPING
Savable	yes, category: communication
Firmware Version	FIR-v1426
Change History	Firmware Version FIR-v1426: Entry "caption" modified from "1A00h Drive Status" to "1A00h Transmit PDO 1 Mapping Parameter". Firmware Version FIR-v1426: Entry "Object Name" modified from "Drive Status" to "Transmit PDO 1 Mapping Parameter".

### Value description

Subindex	00 <sub>h</sub>
Name	Highest Sub-index Supported
Data type	UNSIGNED8
Access	Read/write
PDO Mapping	No
Admissible Values	
Specified Value	02 <sub>h</sub>
Subindex	01 <sub>h</sub>
Name	1st Object To Be Mapped
Data type	UNSIGNED32
Access	Read/write
PDO Mapping	No
Admissible Values	
Specified Value	60410010 <sub>h</sub>
Subindex	02 <sub>h</sub>
Name	2nd Object To Be Mapped
Data type	UNSIGNED32
Access	Read/write
PDO Mapping	No
Admissible Values	
Specified Value	60640020 <sub>h</sub>
Subindex	03 <sub>h</sub>
Name	3rd Object To Be Mapped

Data type	UNSIGNED32
Access	Read/write
PDO Mapping	No
Admissible Values	
Specified Value	00000000 <sub>h</sub>
Subindex	04 <sub>h</sub>
Name	4th Object To Be Mapped
Data type	UNSIGNED32
Access	Read/write
PDO Mapping	No
Admissible Values	
Specified Value	00000000 <sub>h</sub>
Subindex	05 <sub>h</sub>
Name	5th Object To Be Mapped
Data type	UNSIGNED32
Access	Read/write
PDO Mapping	No
Admissible Values	
Specified Value	00000000 <sub>h</sub>
Subindex	06 <sub>h</sub>
Name	6th Object To Be Mapped
Data type	UNSIGNED32
Access	Read/write
PDO Mapping	No
Admissible Values	
Specified Value	00000000 <sub>h</sub>
Subindex	07 <sub>h</sub>
Name	7th Object To Be Mapped
Data type	UNSIGNED32
Access	Read/write
PDO Mapping	No
Admissible Values	
Specified Value	00000000 <sub>h</sub>
Subindex	08 <sub>h</sub>
Name	8th Object To Be Mapped
Data type	UNSIGNED32
Access	Read/write
PDO Mapping	No
Admissible Values	
Specified Value	00000000 <sub>h</sub>

### Description

Each subindex (1-8) describes a mapped object.

A mapping entry consists of four bytes made up according to the following graphic.

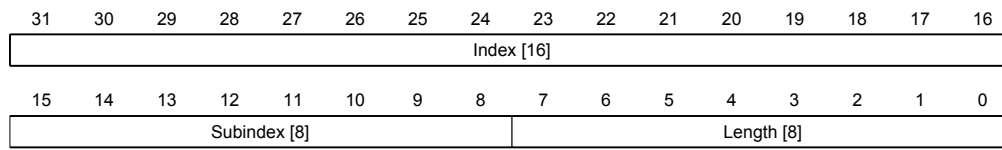

**Index [16]**

Contains the index of the object to be mapped

**Subindex [8]**

Contains the subindex of the object to be mapped

**Length [8]**

Contains the length of the object to be mapped in the bit unit.

## 1A01h Transmit PDO 2 Mapping Parameter

**Function**

This object specifies an output PDO mapping of the active field bus (EtherCAT or CANopen).

**Object description**

Index	1A01h
Object Name	Transmit PDO 2 Mapping Parameter
Object Code	RECORD
Data type	PDO_MAPPING
Savable	yes, category: communication
Firmware Version	FIR-v1426
Change History	Firmware Version FIR-v1426: Entry "caption" modified from "1A01h Positioning Status" to "1A01h Transmit PDO 2 Mapping Parameter". Firmware Version FIR-v1426: Entry "Object Name" modified from "Positioning Status" to "Transmit PDO 2 Mapping Parameter".

**Value description**

Subindex	00 <sub>h</sub>
Name	Highest Sub-index Supported
Data type	UNSIGNED8
Access	Read/write
PDO Mapping	No
Admissible Values	
Specified Value	01 <sub>h</sub>
Subindex	01 <sub>h</sub>
Name	1st Object To Be Mapped
Data type	UNSIGNED32
Access	Read/write
PDO Mapping	No
Admissible Values	
Specified Value	60640020 <sub>h</sub>

Subindex	02 <sub>h</sub>
Name	2nd Object To Be Mapped
Data type	UNSIGNED32
Access	Read/write
PDO Mapping	No
Admissible Values	
Specified Value	00000000 <sub>h</sub>
Subindex	03 <sub>h</sub>
Name	3rd Object To Be Mapped
Data type	UNSIGNED32
Access	Read/write
PDO Mapping	No
Admissible Values	
Specified Value	00000000 <sub>h</sub>
Subindex	04 <sub>h</sub>
Name	4th Object To Be Mapped
Data type	UNSIGNED32
Access	Read/write
PDO Mapping	No
Admissible Values	
Specified Value	00000000 <sub>h</sub>
Subindex	05 <sub>h</sub>
Name	5th Object To Be Mapped
Data type	UNSIGNED32
Access	Read/write
PDO Mapping	No
Admissible Values	
Specified Value	00000000 <sub>h</sub>
Subindex	06 <sub>h</sub>
Name	6th Object To Be Mapped
Data type	UNSIGNED32
Access	Read/write
PDO Mapping	No
Admissible Values	
Specified Value	00000000 <sub>h</sub>
Subindex	07 <sub>h</sub>
Name	7th Object To Be Mapped
Data type	UNSIGNED32
Access	Read/write
PDO Mapping	No
Admissible Values	
Specified Value	00000000 <sub>h</sub>
Subindex	08 <sub>h</sub>



Name	8th Object To Be Mapped
Data type	UNSIGNED32
Access	Read/write
PDO Mapping	No
Admissible Values	
Specified Value	00000000 <sub>h</sub>

### Description

Each subindex (1-8) describes a mapped object.

A mapping entry consists of four bytes made up according to the following graphic.

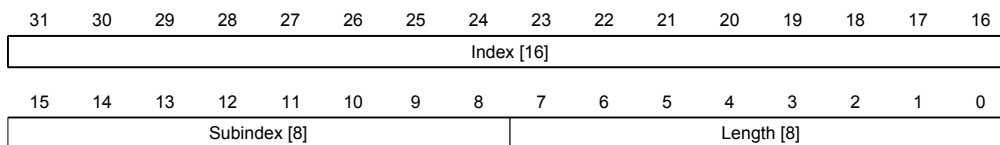

#### Index [16]

Contains the index of the object to be mapped

#### Subindex [8]

Contains the subindex of the object to be mapped

#### Length [8]

Contains the length of the object to be mapped in the bit unit.

## 1A02h Transmit PDO 3 Mapping Parameter

### Function

This object specifies an output PDO mapping of the active field bus (EtherCAT or CANopen).

### Object description

Index	1A02h
Object Name	Transmit PDO 3 Mapping Parameter
Object Code	RECORD
Data type	PDO_MAPPING
Savable	yes, category: communication
Firmware Version	FIR-v1426
Change History	Firmware Version FIR-v1426: Entry "caption" modified from "1A02h Velocity Status" to "1A02h Transmit PDO 3 Mapping Parameter". Firmware Version FIR-v1426: Entry "Object Name" modified from "Velocity Status" to "Transmit PDO 3 Mapping Parameter".

### Value description

Subindex	00 <sub>h</sub>
Name	Highest Sub-index Supported
Data type	UNSIGNED8
Access	Read/write
PDO Mapping	No

Admissible Values	
Specified Value	01 <sub>h</sub>
<hr/>	
Subindex	01 <sub>h</sub>
Name	1st Object To Be Mapped
Data type	UNSIGNED32
Access	Read/write
PDO Mapping	No
Admissible Values	
Specified Value	60440010 <sub>h</sub>
<hr/>	
Subindex	02 <sub>h</sub>
Name	2nd Object To Be Mapped
Data type	UNSIGNED32
Access	Read/write
PDO Mapping	No
Admissible Values	
Specified Value	00000000 <sub>h</sub>
<hr/>	
Subindex	03 <sub>h</sub>
Name	3rd Object To Be Mapped
Data type	UNSIGNED32
Access	Read/write
PDO Mapping	No
Admissible Values	
Specified Value	00000000 <sub>h</sub>
<hr/>	
Subindex	04 <sub>h</sub>
Name	4th Object To Be Mapped
Data type	UNSIGNED32
Access	Read/write
PDO Mapping	No
Admissible Values	
Specified Value	00000000 <sub>h</sub>
<hr/>	
Subindex	05 <sub>h</sub>
Name	5th Object To Be Mapped
Data type	UNSIGNED32
Access	Read/write
PDO Mapping	No
Admissible Values	
Specified Value	00000000 <sub>h</sub>
<hr/>	
Subindex	06 <sub>h</sub>
Name	6th Object To Be Mapped
Data type	UNSIGNED32
Access	Read/write
PDO Mapping	No
Admissible Values	

Specified Value	00000000 <sub>h</sub>
Subindex	07 <sub>h</sub>
Name	7th Object To Be Mapped
Data type	UNSIGNED32
Access	Read/write
PDO Mapping	No
Admissible Values	
Specified Value	00000000 <sub>h</sub>
Subindex	08 <sub>h</sub>
Name	8th Object To Be Mapped
Data type	UNSIGNED32
Access	Read/write
PDO Mapping	No
Admissible Values	
Specified Value	00000000 <sub>h</sub>

### Description

Each subindex (1-8) describes a mapped object.

A mapping entry consists of four bytes made up according to the following graphic.

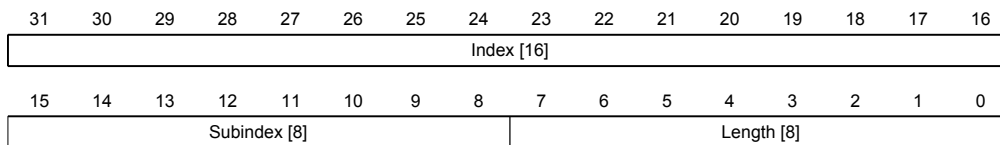

### Index [16]

Contains the index of the object to be mapped

### Subindex [8]

Contains the subindex of the object to be mapped

### Length [8]

Contains the length of the object to be mapped in the bit unit.

## 1A03h Transmit PDO 4 Mapping Parameter

### Function

This object specifies an output PDO mapping of the active field bus (EtherCAT or CANopen).

### Object description

Index	1A03h
Object Name	Transmit PDO 4 Mapping Parameter
Object Code	RECORD
Data type	PDO_MAPPING
Savable	yes, category: communication
Firmware Version	FIR-v1426

Change History                      Firmware Version FIR-v1426: Entry "caption" modified from "1A03h Input Status" to "1A03h Transmit PDO 4 Mapping Parameter".

    Firmware Version FIR-v1426: Entry "Object Name" modified from "Input Status" to "Transmit PDO 4 Mapping Parameter".

**Value description**

Subindex	00 <sub>h</sub>
Name	Highest Sub-index Supported
Data type	UNSIGNED8
Access	Read/write
PDO Mapping	No
Admissible Values	
Specified Value	01 <sub>h</sub>
Subindex	01 <sub>h</sub>
Name	1st Object To Be Mapped
Data type	UNSIGNED32
Access	Read/write
PDO Mapping	No
Admissible Values	
Specified Value	60FD0020 <sub>h</sub>
Subindex	02 <sub>h</sub>
Name	2nd Object To Be Mapped
Data type	UNSIGNED32
Access	Read/write
PDO Mapping	No
Admissible Values	
Specified Value	00000000 <sub>h</sub>
Subindex	03 <sub>h</sub>
Name	3rd Object To Be Mapped
Data type	UNSIGNED32
Access	Read/write
PDO Mapping	No
Admissible Values	
Specified Value	00000000 <sub>h</sub>
Subindex	04 <sub>h</sub>
Name	4th Object To Be Mapped
Data type	UNSIGNED32
Access	Read/write
PDO Mapping	No
Admissible Values	
Specified Value	00000000 <sub>h</sub>
Subindex	05 <sub>h</sub>
Name	5th Object To Be Mapped

Data type	UNSIGNED32
Access	Read/write
PDO Mapping	No
Admissible Values	
Specified Value	00000000 <sub>h</sub>
<hr/>	
Subindex	06 <sub>h</sub>
Name	6th Object To Be Mapped
Data type	UNSIGNED32
Access	Read/write
PDO Mapping	No
Admissible Values	
Specified Value	00000000 <sub>h</sub>
<hr/>	
Subindex	07 <sub>h</sub>
Name	7th Object To Be Mapped
Data type	UNSIGNED32
Access	Read/write
PDO Mapping	No
Admissible Values	
Specified Value	00000000 <sub>h</sub>
<hr/>	
Subindex	08 <sub>h</sub>
Name	8th Object To Be Mapped
Data type	UNSIGNED32
Access	Read/write
PDO Mapping	No
Admissible Values	
Specified Value	00000000 <sub>h</sub>

### Description

Each subindex (1-8) describes a mapped object.

A mapping entry consists of four bytes made up according to the following graphic.

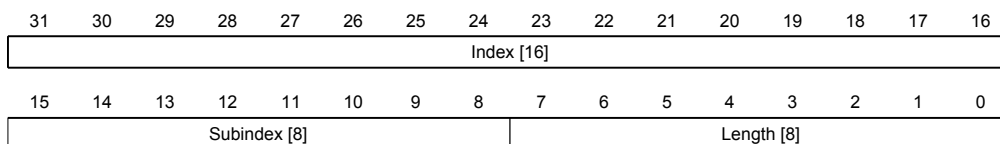

#### Index [16]

Contains the index of the object to be mapped

#### Subindex [8]

Contains the subindex of the object to be mapped

#### Length [8]

Contains the length of the object to be mapped in the bit unit.

## 2005h CANopen Baudrate

### Function

This object contains the baud rate of the CANopen bus if a value greater than or equal to "80"<sub>h</sub> was set at the rotary switches.

### Object description

Index	2005 <sub>h</sub>
Object Name	CANopen Baudrate
Object Code	VARIABLE
Data type	UNSIGNED8
Savable	yes, category: communication
Access	Read/write
PDO Mapping	No
Admissible Values	
Specified Value	88 <sub>h</sub>
Firmware Version	FIR-v1426
Change History	

### Description

The baud rates are to be set according to the following table. Every value outside of this table is interpreted as 1000 kBd.

Value		Baud rate
dec	hex	in kBd
129	81	10
130	82	20
131	83	50
132	84	125
133	85	250
134	86	500
136	88	1000

## 2009h CANopen NodeID

### Function

This object contains the NodeID of the device that is used if the rotary switches were used to set the number 00<sub>h</sub> or 80<sub>h</sub>.

### Object description

Index	2009 <sub>h</sub>
Object Name	CANopen NodeID
Object Code	VARIABLE
Data type	UNSIGNED8
Savable	yes, category: communication
Access	Read/write
PDO Mapping	No

Admissible Values	
Specified Value	7F <sub>h</sub>
Firmware Version	FIR-v1426
Change History	

## 2010h IP-Configuration

### Function

This object is used to set the network configuration.

### Object description

Index	2010 <sub>h</sub>
Object Name	IP-Configuration
Object Code	VARIABLE
Data type	UNSIGNED32
Savable	yes, category: communication
Access	Read/write
PDO Mapping	No
Admissible Values	
Specified Value	00000000 <sub>h</sub>
Firmware Version	FIR-v1426
Change History	

### Description

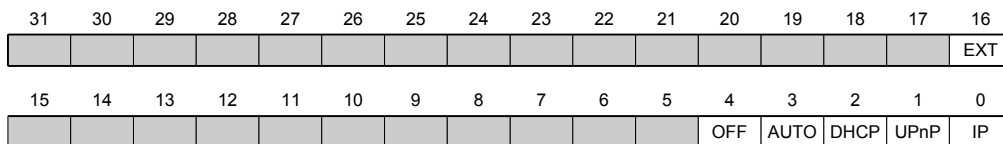

#### IP

Value = "1": A static IP address is used from object **2011<sub>h</sub>** and the network mask from object **2012<sub>h</sub>** is used.

#### UPnP

Value = "1": UPnP (Universal Plug and Play) notifications will be activated

#### DHCP

Value = "1": IP address allocation by a DHCP server will be activated

#### AUTO

Value = "1": IP address allocation by the AUTO-IP protocol will be activated

#### OFF

Value = "1": Network interface will be deactivated

## 2011h Static-IPv4-Address

### Function

Contains the static IPv4 address in the form of a 32-bit word.

## Object description

Index	2011 <sub>h</sub>
Object Name	Static-IPv4-Address
Object Code	VARIABLE
Data type	UNSIGNED32
Savable	yes, category: communication
Access	Read/write
PDO Mapping	No
Admissible Values	
Specified Value	00000000 <sub>h</sub>
Firmware Version	FIR-v1426
Change History	Firmware Version FIR-v1450: Entry "Object Name" modified from "Static-IP-Address" to "Static-IPv4-Address".

## Description

31	30	29	28	27	26	25	24	23	22	21	20	19	18	17	16
IP Address Part 1 [8]								IP Address Part 2 [8]							
15	14	13	12	11	10	9	8	7	6	5	4	3	2	1	0
IP Address Part 3 [8]								IP Address Part 4 [8]							

### IP Address Part 1 [8]

Specifies the first part of the IP address

### IP Address Part 2 [8]

Specifies the second part of the IP address

### IP Address Part 3 [8]

Specifies the third part of the IP address

### IP Address Part 4 [8]

Specifies the fourth part of the IP address

## Example

The address 192.168.2.0 is first converted to the hexadecimal notation and then yields the following configuration value:

192 => C0<sub>h</sub>

168 => A8<sub>h</sub>

2 => 02<sub>h</sub>

0 => 0

The associated setting value is then C0A80200<sub>h</sub>.

## 2012h Static-IPv4-Subnet-Mask

### Function

Contains the subnet mask of the static IP address in the form of a 32-bit word.



## Object description

Index	2012 <sub>h</sub>
Object Name	Static-IPv4-Subnet-Mask
Object Code	VARIABLE
Data type	UNSIGNED32
Savable	yes, category: communication
Access	Read/write
PDO Mapping	No
Admissible Values	
Specified Value	00000000 <sub>h</sub>
Firmware Version	FIR-v1426
Change History	Firmware Version FIR-v1450: Entry "Object Name" modified from "Static-IP-Subnet-Mask" to "Static-IPv4-Subnet-Mask".

## Description

31	30	29	28	27	26	25	24	23	22	21	20	19	18	17	16
Subnet Mask Part 1 [8]								Subnet Mask Part 2 [8]							
15	14	13	12	11	10	9	8	7	6	5	4	3	2	1	0
Subnet Mask Part 3 [8]								Subnet Mask Part 4 [8]							

### Subnet Mask Part 1 [8]

Specifies the first part of the subnet mask

### Subnet Mask Part 2 [8]

Specifies the second part of the subnet mask

### Subnet Mask Part 3 [8]

Specifies the third part of the subnet mask

### Subnet Mask Part 4 [8]

Specifies the fourth part of the subnet mask

## Example

The class C network mask 255.255.255.0 is first converted to the hexadecimal system and then yields the following configuration value:

255 => FF<sub>h</sub>

0 => 0

The associated setting value is then FFFFFFF0<sub>h</sub>.

## 2014h Current-IPv4-Address

### Function

Contains the currently active IP address in the form of a 32-bit word.

### Object description

Index	2014 <sub>h</sub>
Object Name	Current-IPv4-Address

Object Code	VARIABLE
Data type	UNSIGNED32
Savable	No
Access	Read only
PDO Mapping	No
Admissible Values	
Specified Value	00000000 <sub>h</sub>
Firmware Version	FIR-v1426
Change History	Firmware Version FIR-v1450: Entry "Object Name" modified from "Current-IP-Address" to "Current-IPv4-Address".

## Description

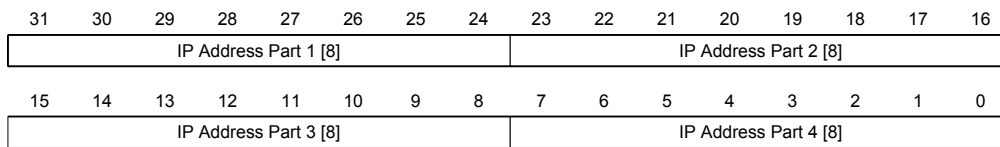

### IP Address Part 1 [8]

Specifies the first part of the IP address

### IP Address Part 2 [8]

Specifies the second part of the IP address

### IP Address Part 3 [8]

Specifies the third part of the IP address

### IP Address Part 4 [8]

Specifies the fourth part of the IP address

## Example

The address 192.168.2.0 is first converted to the hexadecimal notation and then yields the following configuration value:

192 => C0<sub>h</sub>

168 => A8<sub>h</sub>

2 => 02<sub>h</sub>

0 => 0

The associated setting value is then C0A80200<sub>h</sub>.

## 2015h Current-IPv4-Subnet-Mask

### Function

Contains the currently active subnet mask of the static IP address in the form of a 32-bit word.

### Object description

Index	2015 <sub>h</sub>
Object Name	Current-IPv4-Subnet-Mask
Object Code	VARIABLE

Data type	UNSIGNED32
Savable	No
Access	Read only
PDO Mapping	No
Admissible Values	
Specified Value	00000000 <sub>h</sub>
Firmware Version	FIR-v1426
Change History	Firmware Version FIR-v1450: Entry "Object Name" modified from "Current-IP-Subnet-Mask" to "Current-IPv4-Subnet-Mask".

## Description

31	30	29	28	27	26	25	24	23	22	21	20	19	18	17	16
Subnet Mask Part 1 [8]								Subnet Mask Part 2 [8]							
15	14	13	12	11	10	9	8	7	6	5	4	3	2	1	0
Subnet Mask Part 3 [8]								Subnet Mask Part 4 [8]							

### Subnet Mask Part 1 [8]

Specifies the first part of the subnet mask

### Subnet Mask Part 2 [8]

Specifies the second part of the subnet mask

### Subnet Mask Part 3 [8]

Specifies the third part of the subnet mask

### Subnet Mask Part 4 [8]

Specifies the fourth part of the subnet mask

## Example

The class C network mask 255 . 255 . 255 . 0 is first converted to the hexadecimal system and then yields the following configuration value:

255 => FF<sub>h</sub>

0 => 0

The associated setting value is then FFFFFFFF00<sub>h</sub>.

## 2030h Pole Pair Count

### Function

Contains the pole pair count of the connected motor.

### Object description

Index	2030 <sub>h</sub>
Object Name	Pole Pair Count
Object Code	VARIABLE
Data type	UNSIGNED32
Savable	No
Access	Read/write

PDO Mapping	No
Admissible Values	
Specified Value	00000032 <sub>h</sub>
Firmware Version	FIR-v1426
Change History	Version FIR-v1422-B36464: Name entry changed from "Pole pair count" to "Pole Pair Count"

## 2031h Peak Current

### Function

Specifies the maximum current in mA.

### Object description

Index	2031 <sub>h</sub>
Object Name	Peak Current
Object Code	VARIABLE
Data type	UNSIGNED32
Savable	yes, category: application
Access	Read/write
PDO Mapping	No
Admissible Values	
Specified Value	00000708 <sub>h</sub>
Firmware Version	FIR-v1426
Change History	

## 2032h Maximum Speed

### Function

Specifies the maximum admissible speed of the v-control in revolutions/s or rpm.

### Object description

Index	2032 <sub>h</sub>
Object Name	Maximum Speed
Object Code	VARIABLE
Data type	UNSIGNED32
Savable	yes, category: application
Access	Read/write
PDO Mapping	No
Admissible Values	
Specified Value	00030D40 <sub>h</sub>
Firmware Version	FIR-v1426
Change History	

### Description

The conversion is based on the numerator and denominator specified in object **604C<sub>h</sub>**.

## 2033h Plunger Block

### Function

Specifies the maximum positional change in user units (corresponding to Target Position **607A<sub>h</sub>**) that is permitted in the corresponding direction.

### Object description

Index	2033 <sub>h</sub>
Object Name	Plunger Block
Object Code	VARIABLE
Data type	INTEGER32
Savable	yes, category: application
Access	Read/write
PDO Mapping	No
Admissible Values	
Specified Value	00000000 <sub>h</sub>
Firmware Version	FIR-v1426
Change History	

### Description

This is used to implement an electronic lock.

The value 0 switches the monitoring of.

For example, the value 100 means that the drive may move in the negative direction by any distance, but as soon as it moves in the positive direction by more than 100 steps the motor is stopped immediately and an error is output.

For example, when winding up threads, this can be used to prevent an accidental unwinding of threads.

## 2034h Upper Voltage Warning Level

### Function

This object holds the threshold level for the "Overvoltage" error in millivolts.

### Object description

Index	2034 <sub>h</sub>
Object Name	Upper Voltage Warning Level
Object Code	VARIABLE
Data type	UNSIGNED32
Savable	yes, category: application
Access	Read/write
PDO Mapping	No
Admissible Values	
Specified Value	000128E0 <sub>h</sub>
Firmware Version	FIR-v1426
Change History	

### Description

If the input voltage of the motor controller rises above this threshold value, the motor is switched off and an error is output. This error is automatically reset when the input voltage is less than (voltage of the object **2036<sub>h</sub>** minus 2 volts).

## 2035h Lower Voltage Warning Level

### Function

This object holds the threshold level for the "Undervoltage" error in millivolts.

### Object description

Index	2035 <sub>h</sub>
Object Name	Lower Voltage Warning Level
Object Code	VARIABLE
Data type	UNSIGNED32
Savable	yes, category: application
Access	Read/write
PDO Mapping	No
Admissible Values	
Specified Value	00004650 <sub>h</sub>
Firmware Version	FIR-v1426
Change History	

### Description

If the input voltage of the motor controller drops below this threshold value, the motor is switched off and an error is output. This error is automatically reset when the input voltage is greater than (voltage of the object **2035<sub>h</sub>** plus 2 volts).

## 2036h Open Loop Current Reduction Idle Time

### Function

This object specifies the time in milliseconds for which the motor must be idling before the current reduction is activated.

### Object description

Index	2036 <sub>h</sub>
Object Name	Open Loop Current Reduction Idle Time
Object Code	VARIABLE
Data type	UNSIGNED32
Savable	yes, category: application
Access	Read/write
PDO Mapping	No
Admissible Values	
Specified Value	000003E8 <sub>h</sub>
Firmware Version	FIR-v1426
Change History	

## 2037h Open Loop Current Reduction Value/factor

### Function

This object specifies the value to which the current must be reduced when current reduction is activated in open loop.

### Object description

Index	2037 <sub>h</sub>
Object Name	Open Loop Current Reduction Value/factor
Object Code	VARIABLE
Data type	INTEGER32
Savable	yes, category: application
Access	Read/write
PDO Mapping	No
Admissible Values	
Specified Value	FFFFFFCE <sub>h</sub>
Firmware Version	FIR-v1426
Change History	

### Description

If the value is negative between "-100" and "-1", this is interpreted as the percentage reduction factor relative to the maximum current ( **2031<sub>h</sub>**). The value "-100" corresponds to 100% of the value in object **2031<sub>h</sub>**, and the value "-50" is interpreted as 50% of the value in object **2031<sub>h</sub>**, etc.

If the value is positive, the current is reduced to the value in mA entered in object **2037<sub>h</sub>**.

## 2038h Brake Controller Timing

### Function

This object contains the times for the brake controller in milliseconds as well as the PWM frequency and duty cycle.

### Object description

Index	2038 <sub>h</sub>
Object Name	Brake Controller Timing
Object Code	ARRAY
Data type	UNSIGNED32
Savable	yes, category: application
Firmware Version	FIR-v1426
Change History	

### Value description

Subindex	00 <sub>h</sub>
Name	Highest Sub-index Supported
Data type	UNSIGNED8
Access	Read only
PDO Mapping	No
Admissible Values	

Specified Value	06 <sub>h</sub>
Subindex	01 <sub>h</sub>
Name	Close Brake Idle Time
Data type	UNSIGNED32
Access	Read/write
PDO Mapping	No
Admissible Values	
Specified Value	000003E8 <sub>h</sub>
Subindex	02 <sub>h</sub>
Name	Shutdown Power Idle Time
Data type	UNSIGNED32
Access	Read/write
PDO Mapping	No
Admissible Values	
Specified Value	000003E8 <sub>h</sub>
Subindex	03 <sub>h</sub>
Name	Open Brake Delay Time
Data type	UNSIGNED32
Access	Read/write
PDO Mapping	No
Admissible Values	
Specified Value	000003E8 <sub>h</sub>
Subindex	04 <sub>h</sub>
Name	Start Operation Delay Time
Data type	UNSIGNED32
Access	Read/write
PDO Mapping	No
Admissible Values	
Specified Value	000003E8 <sub>h</sub>
Subindex	05 <sub>h</sub>
Name	PWM Frequency
Data type	UNSIGNED32
Access	Read/write
PDO Mapping	No
Admissible Values	between 1 and 2000 (7D0 <sub>h</sub> )
Specified Value	00000000 <sub>h</sub>
Subindex	06 <sub>h</sub>
Name	PWM Duty Cycle
Data type	UNSIGNED32
Access	Read/write
PDO Mapping	No
Admissible Values	between 2 and 100
Specified Value	00000000 <sub>h</sub>



## Description

The subindices have the following functions:

- 01<sub>h</sub>: Time between when the motor begins idle and the brake closes.
- 02<sub>h</sub>: Time between when the brake closes and the current is lowered.
- 03<sub>h</sub>: Time between when a new move command is set and the brake is opened.
- 04<sub>h</sub>: Time between when the brake is opened and the motor starts.
- 05<sub>h</sub>: Frequency of the brake PWM in hertz.
- 06<sub>h</sub>: Duty cycle of the brake PWM in percent.

## 2039h Motor Currents

### Function

This object contains the measured motor currents in mA.

### Object description

Index	2039 <sub>h</sub>
Object Name	Motor Currents
Object Code	ARRAY
Data type	INTEGER32
Savable	No
Firmware Version	FIR-v1426
Change History	<p>Firmware Version FIR-v1504: Table entry "PDO Mapping" at subindex 01 modified from "No" to "TX - PDO".</p> <p>Firmware Version FIR-v1504: Table entry "PDO Mapping" at subindex 02 modified from "No" to "TX - PDO".</p> <p>Firmware Version FIR-v1504: Table entry "PDO Mapping" at subindex 03 modified from "No" to "TX - PDO".</p> <p>Firmware Version FIR-v1504: Table entry "PDO Mapping" at subindex 04 modified from "No" to "TX - PDO".</p>

### Value description

Subindex	00 <sub>h</sub>
Name	Highest Sub-index Supported
Data type	UNSIGNED8
Access	Read only
PDO Mapping	No
Admissible Values	
Specified Value	04 <sub>h</sub>

Subindex	01 <sub>h</sub>
Name	I_d
Data type	INTEGER32
Access	Read only
PDO Mapping	TX - PDO
Admissible Values	
Specified Value	00000000 <sub>h</sub>

Subindex	02 <sub>h</sub>
Name	I_q
Data type	INTEGER32
Access	Read only
PDO Mapping	TX - PDO
Admissible Values	
Specified Value	00000000 <sub>h</sub>
Subindex	03 <sub>h</sub>
Name	I_a
Data type	INTEGER32
Access	Read only
PDO Mapping	TX - PDO
Admissible Values	
Specified Value	00000000 <sub>h</sub>
Subindex	04 <sub>h</sub>
Name	I_b
Data type	INTEGER32
Access	Read only
PDO Mapping	TX - PDO
Admissible Values	
Specified Value	00000000 <sub>h</sub>

## 203Ah Homing On Block Configuration

### Function

This object contains the parameters for homing on block (see the " **Homing**" section).

### Object description

Index	203A <sub>h</sub>
Object Name	Homing On Block Configuration
Object Code	ARRAY
Data type	UNSIGNED32
Savable	No
Access	
PDO Mapping	
Admissible Values	
Specified Value	
Firmware Version	FIR-v1426
Change History	Amount of subentries has changed from 3 to 4

### Value description

Subindex	00 <sub>h</sub>
Name	Highest Sub-index Supported
Data type	UNSIGNED8
Access	Read only

PDO Mapping	No
Admissible Values	
Specified Value	03 <sub>h</sub>
<hr/>	
Subindex	01 <sub>h</sub>
Name	Minimum Current For Block Detection
Data type	UNSIGNED32
Access	Read/write
PDO Mapping	No
Admissible Values	
Specified Value	00000000 <sub>h</sub>
<hr/>	
Subindex	02 <sub>h</sub>
Name	Period Of Blocking
Data type	UNSIGNED32
Access	Read/write
PDO Mapping	No
Admissible Values	
Specified Value	00000000 <sub>h</sub>
<hr/>	
Subindex	03 <sub>h</sub>
Name	Block Detection Time
Data type	UNSIGNED32
Access	Read/write
PDO Mapping	No
Admissible Values	
Specified Value	00000000 <sub>h</sub>

### Description

The subentries have the following function:

- 01<sub>h</sub>: Specifies the current limit value from which blocking is to be detected.
- 02<sub>h</sub>: Specifies the time in ms that the motor is nevertheless still to travel against the block after block detection.
- 03<sub>h</sub>: Specifies the time in ms that the current has to be at least above the minimum current threshold in order to detect a block.

## 203Bh I<sup>2</sup>t Parameters

### Function

This object contains the parameters for the I<sup>2</sup>t monitoring.

The I<sup>2</sup>t monitoring is activated when a value greater than 0 is entered in 203B<sub>h</sub>:02<sub>h</sub> (see " **I<sup>2</sup>t motor overload protection** ").

I<sup>2</sup>t can only be use for closed loop mode with a single exception: If I<sup>2</sup>t is activated in open loop mode, the current is limited to the set nominal current even when the set maximum current is greater. This feature was implemented for safety reasons, so that it is also possible to switch out of closed loop mode and into open loop mode with a very high short-time maximum current without damaging the motor.

### Object description

Index	203B <sub>h</sub>
Object Name	I2t Parameters
Object Code	ARRAY
Data type	UNSIGNED32
Savable	No
Firmware Version	FIR-v1426
Change History	

### Value description

Subindex	00 <sub>h</sub>
Name	Highest Sub-index Supported
Data type	UNSIGNED8
Access	Read only
PDO Mapping	No
Admissible Values	
Specified Value	06 <sub>h</sub>

Subindex	01 <sub>h</sub>
Name	Nominal Current
Data type	UNSIGNED32
Access	Read/write
PDO Mapping	No
Admissible Values	
Specified Value	00000000 <sub>h</sub>

Subindex	02 <sub>h</sub>
Name	Maximum Duration Of Peak Current
Data type	UNSIGNED32
Access	Read/write
PDO Mapping	No
Admissible Values	
Specified Value	00000000 <sub>h</sub>

Subindex	03 <sub>h</sub>
Name	Threshold
Data type	UNSIGNED32
Access	Read/write
PDO Mapping	No
Admissible Values	
Specified Value	00000000 <sub>h</sub>

Subindex	04 <sub>h</sub>
Name	CalcValue
Data type	UNSIGNED32
Access	Read/write
PDO Mapping	No
Admissible Values	

Specified Value	00000000 <sub>h</sub>
Subindex	05 <sub>h</sub>
Name	LimitedCurrent
Data type	UNSIGNED32
Access	Read/write
PDO Mapping	No
Admissible Values	
Specified Value	00000000 <sub>h</sub>
Subindex	06 <sub>h</sub>
Name	Status
Data type	UNSIGNED32
Access	Read/write
PDO Mapping	No
Admissible Values	
Specified Value	00000000 <sub>h</sub>

### Description

The subentries have the following function:

- 01<sub>h</sub>: Specifies the nominal current in mA, must be smaller than the maximum current **2031<sub>h</sub>**, otherwise monitoring will not be activated.
- 02<sub>h</sub>: Specifies the maximum time period of the peak current in ms.
- 03<sub>h</sub>: Threshold, specifies the limit in mA, from which is determined whether switching is to the maximum current or nominal current.
- 04<sub>h</sub>: CalcValue, specifies the calculated value that is compared to the threshold in order to set the current.
- 05<sub>h</sub>: LimitedCurrent, shows the actual current value that was set by I<sup>2</sup>t.
- 06<sub>h</sub>: Actual status. If the subentry value is "0", I<sup>2</sup>t is deactivated; if the value is "1", I<sup>2</sup>t is activated

## 2050h Encoder Alignment

### Function

This value specifies the angle offset between the rotor and the electrical field.

### Object description

Index	2050 <sub>h</sub>
Object Name	Encoder Alignment
Object Code	VARIABLE
Data type	INTEGER32
Savable	No
Access	Read/write
PDO Mapping	No
Admissible Values	
Specified Value	00000000 <sub>h</sub>
Firmware Version	FIR-v1426
Change History	

## Description

The exact determination is only possible via the auto setup. The presence of this value is required for closed loop mode.

## 2051h Encoder Optimization

### Function

Contains compensation values to attain better concentricity in closed loop mode.

### Object description

Index	2051 <sub>h</sub>
Object Name	Encoder Optimization
Object Code	ARRAY
Data type	INTEGER32
Savable	No
Firmware Version	FIR-v1426
Change History	

### Value description

Subindex	00 <sub>h</sub>
Name	Highest Sub-index Supported
Data type	UNSIGNED8
Access	Read only
PDO Mapping	No
Admissible Values	
Specified Value	03 <sub>h</sub>
Subindex	01 <sub>h</sub>
Name	Parameter 1
Data type	INTEGER32
Access	Read/write
PDO Mapping	No
Admissible Values	
Specified Value	00000000 <sub>h</sub>
Subindex	02 <sub>h</sub>
Name	Parameter 2
Data type	INTEGER32
Access	Read/write
PDO Mapping	No
Admissible Values	
Specified Value	00000000 <sub>h</sub>
Subindex	03 <sub>h</sub>
Name	Parameter 3
Data type	INTEGER32
Access	Read/write
PDO Mapping	No

Admissible Values	
Specified Value	00000000 <sub>h</sub>

---

### Description

The exact determination is only possible via the auto setup.

## 2052h Encoder Resolution

### Function

Contains the resolution of the encoder that is used for electrical commutation.

### Object description

---

Index	2052 <sub>h</sub>
Object Name	Encoder Resolution
Object Code	VARIABLE
Data type	INTEGER32
Savable	No
Access	Read/write
PDO Mapping	No
Admissible Values	
Specified Value	00000000 <sub>h</sub>
Firmware Version	FIR-v1426
Change History	

---

### Description

A negative value means that the encoder is operated in the opposite direction to the motor. This can be corrected by changing the poles of the motor winding.

## 2053h Index Polarity

### Function

Specifies the index polarity.

### Object description

---

Index	2053 <sub>h</sub>
Object Name	Index Polarity
Object Code	VARIABLE
Data type	UNSIGNED8
Savable	No
Access	Read/write
PDO Mapping	No
Admissible Values	
Specified Value	00 <sub>h</sub>
Firmware Version	FIR-v1426
Change History	

---

### Description

The value 0 means that the index is not inverted.

The value 1 means that the index is connected inverted and is inverted in the firmware.

## 2054h Index Width

### Function

Specifies the index width in an internal operand.

### Object description

---

Index	2054 <sub>h</sub>
Object Name	Index Width
Object Code	VARIABLE
Data type	INTEGER32
Savable	No
Access	Read/write
PDO Mapping	TX - PDO
Admissible Values	
Specified Value	FFFFFFFF <sub>h</sub>
Firmware Version	FIR-v1426
Change History	

---

### Description

If this value is not equal to 0, the encoder is monitored for errors.

The value -1 ( FFFFFFFF<sub>h</sub>) deactivates encoder monitoring.

## 2056h Limit Switch Tolerance Band

### Function

Specifies how far positive or negative limit switches may be overrun before the motor controller issues an error.

This tolerance range is required, for example, to be able to complete reference runs - in which limit switches can be activated - error-free.

### Object description

---

Index	2056 <sub>h</sub>
Object Name	Limit Switch Tolerance Band
Object Code	VARIABLE
Data type	UNSIGNED32
Savable	yes, category: application
Access	Read/write
PDO Mapping	TX - PDO
Admissible Values	
Specified Value	000001F4 <sub>h</sub>
Firmware Version	FIR-v1426
Change History	

---



## 2057h Clock Direction Multiplier

### Function

The clock counting value in the clock/direction mode is multiplied by this value before it is processed further.

### Object description

Index	2057 <sub>h</sub>
Object Name	Clock Direction Multiplier
Object Code	VARIABLE
Data type	INTEGER32
Savable	yes, category: application
Access	Read/write
PDO Mapping	No
Admissible Values	
Specified Value	00000080 <sub>h</sub>
Firmware Version	FIR-v1426
Change History	

## 2058h Clock Direction Divider

### Function

The clock counting value in the clock/direction mode is divided by this value before it is processed further.

### Object description

Index	2058 <sub>h</sub>
Object Name	Clock Direction Divider
Object Code	VARIABLE
Data type	INTEGER32
Savable	yes, category: application
Access	Read/write
PDO Mapping	No
Admissible Values	
Specified Value	00000001 <sub>h</sub>
Firmware Version	FIR-v1426
Change History	

## 2059h Encoder Configuration

### Function

This object specifies the supply voltage of the encoder.

### Object description

Index	2059 <sub>h</sub>
Object Name	Encoder Configuration

Object Code	VARIABLE
Data type	UNSIGNED32
Savable	yes, category: application
Access	Read/write
PDO Mapping	No
Admissible Values	
Specified Value	00000000 <sub>h</sub>
Firmware Version	FIR-v1426
Change History	

### Description

31	30	29	28	27	26	25	24	23	22	21	20	19	18	17	16
15	14	13	12	11	10	9	8	7	6	5	4	3	2	1	0
														TYPE	VOLT

#### VOLT

Setting this bit to the value "0" the supply voltage of the encoder is set to 5V. Setting this bit to the value "1" the supply voltage of the encoder is set to 24V.

#### TYPE

Defines the type of the encoder. This bit has to be set to the value "0" if a differential encoder is used. For a single ended encoder, the bit has to be set to the value "1".

## 205Ah Encoder Boot Value

### Function

This object has only a functional purpose, if an absolute encoder is used: From this object, the encoder position (in user units) can be read, which was read from the absolute encoder initially at power up of the controller. This object is always 0 if no absolute encoder is used.

### Object description

Index	205A <sub>h</sub>
Object Name	Encoder Boot Value
Object Code	VARIABLE
Data type	UNSIGNED32
Savable	No
Access	Read/write
PDO Mapping	No
Admissible Values	
Specified Value	00000000 <sub>h</sub>
Firmware Version	FIR-v1446
Change History	

### Description

## 205Bh Clock Direction Or Clockwise/Counter Clockwise Mode

### Function

With this object the clock/direction-mode (value = "0") can be switched to clockwise/counterclockwise mode (value = "1").

### Object description

Index	205B <sub>h</sub>
Object Name	Clock Direction Or Clockwise/Counter Clockwise Mode
Object Code	VARIABLE
Data type	UNSIGNED32
Savable	yes, category: application
Access	Read/write
PDO Mapping	No
Admissible Values	
Specified Value	00000000 <sub>h</sub>
Firmware Version	FIR-v1504
Change History	

## 2060h Compensate Polepair Count

### Function

Makes it possible to order motor-independent motion blocks.

### Object description

Index	2060 <sub>h</sub>
Object Name	Compensate Polepair Count
Object Code	VARIABLE
Data type	UNSIGNED32
Savable	yes, category: application
Access	Read/write
PDO Mapping	No
Admissible Values	
Specified Value	00000001 <sub>h</sub>
Firmware Version	FIR-v1426
Change History	

### Description

If this entry is set to 1, the pole pair count is automatically set for all position, speed, acceleration, and jerk parameters.

If the value is 0, the pole pair count enters into the set values and must be taken into account when the motor is changed, as is the case with conventional stepper motor controllers.

## 2061h Velocity Numerator

### Function

Contains the numerator that is used to convert the speed specifications in profile position mode.

### Object description

Index	2061 <sub>h</sub>
Object Name	Velocity Numerator
Object Code	VARIABLE
Data type	UNSIGNED32
Savable	yes, category: application
Access	Read/write
PDO Mapping	No
Admissible Values	
Specified Value	00000001 <sub>h</sub>
Firmware Version	FIR-v1426
Change History	

### Description

The internal operand pertains to full mechanical ( **2060<sub>h</sub>**=1) or electrical ( **2060<sub>h</sub>**=0) revolutions per second.

Thus, by setting object **2061<sub>h</sub>**=1 and object **2062<sub>h</sub>**=60, for example, the speed can be specified in rpm in profile position mode.

## 2062h Velocity Denominator

### Function

Contains the denominator that is used to convert the speed specifications in profile position mode.

### Object description

Index	2062 <sub>h</sub>
Object Name	Velocity Denominator
Object Code	VARIABLE
Data type	UNSIGNED32
Savable	yes, category: application
Access	Read/write
PDO Mapping	No
Admissible Values	
Specified Value	0000003C <sub>h</sub>
Firmware Version	FIR-v1426
Change History	

### Description

The internal operand pertains to full mechanical ( **2060<sub>h</sub>**=1) or electrical ( **2060<sub>h</sub>**=0) revolutions per second.

Thus, by setting object **2061<sub>h</sub>**=1 and object **2062<sub>h</sub>**=60, for example, the speed can be specified in rpm in profile position mode.

## 2063h Acceleration Numerator

### Function

Contains the numerator that is used to convert the acceleration specifications in profile position mode.

### Object description

Index	2063 <sub>h</sub>
Object Name	Acceleration Numerator
Object Code	VARIABLE
Data type	UNSIGNED32
Savable	yes, category: application
Access	Read/write
PDO Mapping	No
Admissible Values	
Specified Value	00000001 <sub>h</sub>
Firmware Version	FIR-v1426
Change History	

### Description

The internal operand pertains to full mechanical ( **2060<sub>h</sub>**=1) or electrical ( **2060<sub>h</sub>**=0) revolutions per second.

Thus, by setting object **2063<sub>h</sub>**=1 and object **2064<sub>h</sub>**=60, for example, the acceleration can be specified in (revolutions/min)/s<sup>2</sup> in profile position mode.

## 2064h Acceleration Denominator

### Function

Contains the denominator that is used to convert the acceleration specifications in profile position mode.

### Object description

Index	2064 <sub>h</sub>
Object Name	Acceleration Denominator
Object Code	VARIABLE
Data type	UNSIGNED32
Savable	yes, category: application
Access	Read/write
PDO Mapping	No
Admissible Values	
Specified Value	0000003C <sub>h</sub>
Firmware Version	FIR-v1426
Change History	

### Description

The internal operand pertains to full mechanical ( **2060<sub>h</sub>**=1) or electrical ( **2060<sub>h</sub>**=0) revolutions per second.

Thus, by setting object **2063<sub>h</sub>**=1 and object **2064<sub>h</sub>**=60, for example, the acceleration can be specified in (revolutions/min)/s<sup>2</sup> in profile position mode.

## 2065h Jerk Numerator

### Function

Contains the numerator that is used to convert the jerk specifications in profile position mode.

### Object description

Index	2065 <sub>h</sub>
Object Name	Jerk Numerator
Object Code	VARIABLE
Data type	UNSIGNED32
Savable	yes, category: application
Access	Read/write
PDO Mapping	No
Admissible Values	
Specified Value	00000001 <sub>h</sub>
Firmware Version	FIR-v1426
Change History	

### Description

The internal operand pertains to full mechanical ( **2060<sub>h</sub>**=1) or electrical ( **2060<sub>h</sub>**=0) revolutions per second to the power of 3.

Thus, by setting object **2065<sub>h</sub>**=1 and object **2066<sub>h</sub>**=60, for example, the jerk can be specified in (revolutions/min)/s<sup>2</sup> in profile position mode.

## 2066h Jerk Denominator

### Function

Contains the denominator that is used to convert the jerk specifications in profile position mode.

### Object description

Index	2066 <sub>h</sub>
Object Name	Jerk Denominator
Object Code	VARIABLE
Data type	UNSIGNED32
Savable	yes, category: application
Access	Read/write
PDO Mapping	No
Admissible Values	
Specified Value	0000003C <sub>h</sub>
Firmware Version	FIR-v1426
Change History	

### Description

The internal operand pertains to full mechanical ( **2060<sub>h</sub>**=1) or electrical ( **2060<sub>h</sub>**=0) revolutions per second.

Thus, by setting object **2065<sub>h</sub>**=1 and object **2066<sub>h</sub>**=60, for example, the acceleration can be specified in (revolutions/min)/s<sup>2</sup> in profile position mode.

## 2067h Jerk Limit (internal)

### Function

This object contains parts of the calculation for the real jerk limit, this limit is deactivated if this object is set to the value "0".

The following formula describes the calculation of the real jerk limit:

$$\text{Jerk Limit Real} = \frac{\text{Jerk limit internal (2067}_h) \times \text{Jerk denominator (2066}_h)}{2048 \times \text{Jerk numerator (2065}_h) \times \text{Pole Pair Count (2030}_h)}$$

### Object description

Index	2067 <sub>h</sub>
Object Name	Jerk Limit (internal)
Object Code	VARIABLE
Data type	UNSIGNED32
Savable	yes, category: application
Access	Read/write
PDO Mapping	No
Admissible Values	
Specified Value	000F4240 <sub>h</sub>
Firmware Version	FIR-v1450
Change History	

## 2084h Bootup Delay

### Function

This object allows specification of the time period between when the supply voltage is applied to the motor controller and the provision of operability of the motor controller in milliseconds.

### Object description

Index	2084 <sub>h</sub>
Object Name	Bootup Delay
Object Code	VARIABLE
Data type	UNSIGNED32
Savable	yes, category: application
Access	Read/write
PDO Mapping	No
Admissible Values	
Specified Value	00000000 <sub>h</sub>
Firmware Version	FIR-v1426
Change History	

## 2101h Fieldbus Module

### Function

Shows the type of mounted field bus module.

### Object description

Index	2101 <sub>h</sub>
Object Name	Fieldbus Module
Object Code	VARIABLE
Data type	UNSIGNED32
Savable	No
Access	Read only
PDO Mapping	No
Admissible Values	
Specified Value	00000000 <sub>h</sub>
Firmware Version	FIR-v1426
Change History	Firmware Version FIR-v1426: Entry "Data Type" modified from "INTEGER32" to "UNSIGNED32"

### Description

The bits 0 to 15 are representing the physical interface, the bits 16 to 31 the used protocol (if necessary).

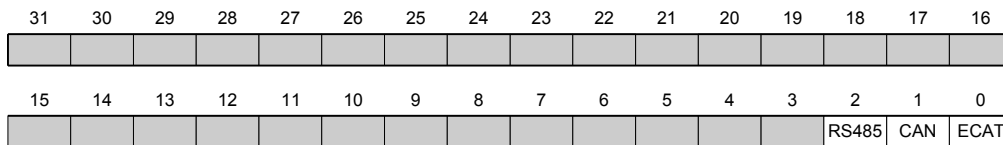

#### USB

Value = "1": An USB interface is available.

#### RS-485

Value = "1": A RS-485 interface is available.

#### RS-232

Value = "1": A RS-232 interface is available.

#### CAN

Value = "1": A CANopen interface is available.

#### E-NET

Value = "1": An EtherNET interface is available.

#### E-CAT

Value = "1": An EtherCAT interface is available.

#### SPI

Value = "1": A SPI interface is available.

#### MRTU

Value = "1": The protocol used is Modbus RTU.



## TCP

Value = "1": The protocol used is TCP/IP

## 2200h Sampler Control

### Function

Controls the installed sampler used to cyclically record any values from the "Dictionary" object.

### Object description

Index	2200 <sub>h</sub>
Object Name	Sampler Control
Object Code	VARIABLE
Data type	UNSIGNED32
Savable	No
Access	Read/write
PDO Mapping	RX - PDO
Admissible Values	
Specified Value	00000000 <sub>h</sub>
Firmware Version	FIR-v1426
Change History	

### Description

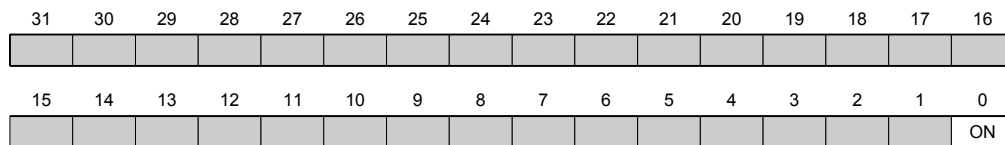

### ON

Value = "1": The sampler will be activated

## 2201h Sampler Status

### Function

Shows the operating state of the installed sampler.

### Object description

Index	2201 <sub>h</sub>
Object Name	Sampler Status
Object Code	VARIABLE
Data type	UNSIGNED32
Savable	No
Access	Read only
PDO Mapping	TX - PDO
Admissible Values	
Specified Value	00000000 <sub>h</sub>
Firmware Version	FIR-v1426

## Change History

### Description

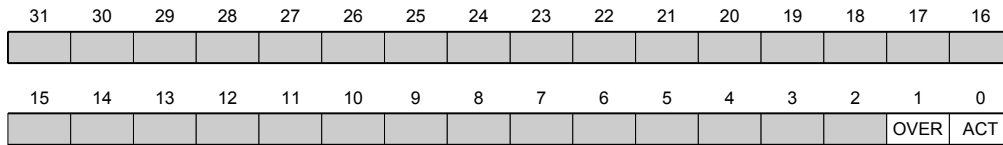

#### ACT

Value = "1": The sampler is active and is recording data.

#### OVER

Value = "1": The recording buffer has not been read out fast enough and data have been lost. The sampler has therefore been stopped and must be restarted by a rising flank in object **2200<sub>h</sub>** bit 0.

## 2202h Sample Data Selection

### Function

The data collected jointly per scan can be controlled here. In the current firmware, the sample buffer size is 12,000 bytes.

### Object description

Index	2202 <sub>h</sub>
Object Name	Sample Data Selection
Object Code	RECORD
Data type	PDO_MAPPING
Savable	No
Firmware Version	FIR-v1426
Change History	

### Value description

Subindex	00 <sub>h</sub>
Name	Highest Sub-index Supported
Data type	UNSIGNED8
Access	Read/write
PDO Mapping	No
Admissible Values	
Specified Value	02 <sub>h</sub>
Subindex	01 <sub>h</sub>
Name	Sample Value #1
Data type	UNSIGNED32
Access	Read/write
PDO Mapping	No
Admissible Values	
Specified Value	60430010 <sub>h</sub>
Subindex	02 <sub>h</sub>

Name	Sample Value #2
Data type	UNSIGNED32
Access	Read/write
PDO Mapping	No
Admissible Values	
Specified Value	22030220 <sub>h</sub>
Subindex	03 <sub>h</sub>
Name	Sample Value #3
Data type	UNSIGNED32
Access	Read/write
PDO Mapping	No
Admissible Values	
Specified Value	00000000 <sub>h</sub>
Subindex	04 <sub>h</sub>
Name	Sample Value #4
Data type	UNSIGNED32
Access	Read/write
PDO Mapping	No
Admissible Values	
Specified Value	00000000 <sub>h</sub>
Subindex	05 <sub>h</sub>
Name	Sample Value #5
Data type	UNSIGNED32
Access	Read/write
PDO Mapping	No
Admissible Values	
Specified Value	00000000 <sub>h</sub>
Subindex	06 <sub>h</sub>
Name	Sample Value #6
Data type	UNSIGNED32
Access	Read/write
PDO Mapping	No
Admissible Values	
Specified Value	00000000 <sub>h</sub>
Subindex	07 <sub>h</sub>
Name	Sample Value #7
Data type	UNSIGNED32
Access	Read/write
PDO Mapping	No
Admissible Values	
Specified Value	00000000 <sub>h</sub>
Subindex	08 <sub>h</sub>
Name	Sample Value #8

Data type	UNSIGNED32
Access	Read/write
PDO Mapping	No
Admissible Values	
Specified Value	00000000 <sub>h</sub>

### Description

Each subindex (1-8) describes a mapped object.

A mapping entry consists of four bytes made up according to the following graphic.

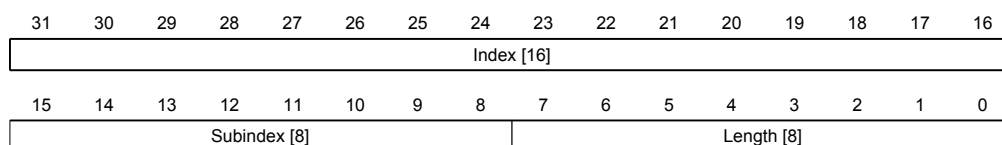

#### Index [16]

Contains the index of the object to be mapped

#### Subindex [8]

Contains the subindex of the object to be mapped

#### Length [8]

Contains the length of the object to be mapped in the bit unit.

## 2203h Sampler Buffer Information

### Function

This object makes additional information available to the sampler.

### Object description

Index	2203 <sub>h</sub>
Object Name	Sampler Buffer Information
Object Code	ARRAY
Data type	UNSIGNED32
Savable	No
Firmware Version	FIR-v1426
Change History	

### Value description

Subindex	00 <sub>h</sub>
Name	Highest Sub-index Supported
Data type	UNSIGNED8
Access	Read only
PDO Mapping	No
Admissible Values	
Specified Value	03 <sub>h</sub>

Subindex	01 <sub>h</sub>
Name	Sample Buffer Size

Data type	UNSIGNED32
Access	Read/write
PDO Mapping	No
Admissible Values	
Specified Value	00000000 <sub>h</sub>
Subindex	02 <sub>h</sub>
Name	Sample Buffer Watermark
Data type	UNSIGNED32
Access	Read/write
PDO Mapping	No
Admissible Values	
Specified Value	00000000 <sub>h</sub>
Subindex	03 <sub>h</sub>
Name	Sample Tick
Data type	UNSIGNED32
Access	Read/write
PDO Mapping	No
Admissible Values	
Specified Value	00000000 <sub>h</sub>

### Description

The subindices have the following functions:

- 01<sub>h</sub> specifies the maximum size of the sampler buffer in bytes.
- 02<sub>h</sub> contains the momentary filling level of the sampler buffer in bytes.
- 03<sub>h</sub> contains a numerator that is incremented with each scan.

## 2204h Sample Time In Ms

### Function

This object contains the scan interval of the sampler in milliseconds.

### Object description

Index	2204 <sub>h</sub>
Object Name	Sample Time In Ms
Object Code	VARIABLE
Data type	UNSIGNED32
Savable	No
Access	Read/write
PDO Mapping	RX - PDO
Admissible Values	
Specified Value	00000001 <sub>h</sub>
Firmware Version	FIR-v1426
Change History	

## 2300h NanoJ Control

### Function

Controls the execution of a user program.

### Object description

Index	2300 <sub>h</sub>
Object Name	NanoJ Control
Object Code	VARIABLE
Data type	UNSIGNED32
Savable	yes, category: application
Access	Read/write
PDO Mapping	RX - PDO
Admissible Values	
Specified Value	00000000 <sub>h</sub>
Firmware Version	FIR-v1426
Change History	Firmware Version FIR-v1436: Entry "Object Name" modified from "VMM Control" to "NanoJ Control".

### Description

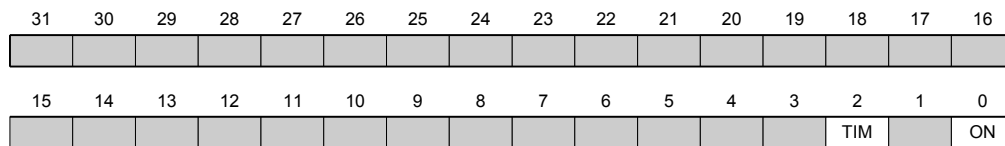

#### ON

Switches the VMM on (value = "1") or off (value = "0").

When there is a rising flank in bit 0, the program is first reloaded and the variable range is reset.

#### TIM

Switches the timing control off (value = "1") or on (value = "0").

## 2301h NanoJ Status

### Function

Shows the operating state of the user program.

### Object description

Index	2301 <sub>h</sub>
Object Name	NanoJ Status
Object Code	VARIABLE
Data type	UNSIGNED32
Savable	No
Access	Read only
PDO Mapping	TX - PDO

Admissible Values

Specified Value 00000000<sub>h</sub>

Firmware Version FIR-v1426

Change History Firmware Version FIR-v1436: Entry "Object Name" modified from "VMM Status" to "NanoJ Status".

**Description**

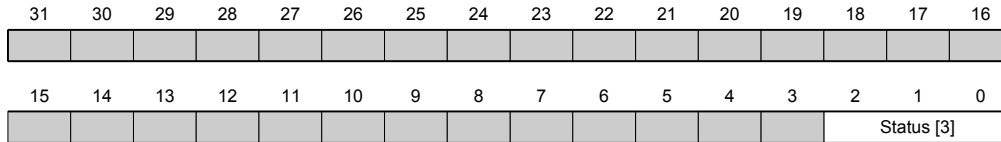

**Status [3]**

Specifies the actual status of the VMM.

- Value = "0": Program has been stopped
- Value = "1": Program is running
- Value = "4": Program was closed with an error. The cause of the error can be read out in object 2302<sub>h</sub>.

**2302h NanoJ Error Code**

**Function**

Indicates which error occurred when the user program was executed.

**Object description**

Index	2302 <sub>h</sub>
Object Name	NanoJ Error Code
Object Code	VARIABLE
Data type	UNSIGNED32
Savable	No
Access	Read only
PDO Mapping	TX - PDO
Admissible Values	
Specified Value	00000000 <sub>h</sub>
Firmware Version	FIR-v1426
Change History	Firmware Version FIR-v1436: Entry "Object Name" modified from "VMM Error Code" to "NanoJ Error Code".

**Description**

Error codes during program execution:

Number	Description
0x0000	No error
0x0001	Invalid service call (Cortex Svc)
0x0002	Memory protection violation (Cortex MPU Fault)

Number	Description
0x0003	Invalid Usage (Cortex error, for example due to an assembler command that is not admissible in the user mode)
0x0004	Hard fault (Cortex error)
0x0005	Timeout of 1-ms cycle
0x0006	Bus fault (Cortex error)
0x0007	Invalid stackpointer
0x0100	Bad program file

File system error codes when loading the user program:

Number	Description
0x10000	Access to an object that doesn't exist in object dictionary
0x10001	Write access to a read only (write protected) object
0x10002	Internal file system fault
0x10003	Storage medium not ready
0x10004	File not found
0x10005	Directory not found
0x10006	Invalid file name/directory name
0x10008	Access to file not possible
0x10009	Invalid file/directory object
0x1000A	Storage medium is write protected
0x1000B	Invalid drive number
0x1000C	Working range of drive is invalid
0x1000D	No valid file system on drive
0x1000E	Creation of the file system has failed
0x1000F	Access not possible within required time
0x10010	Access was rejected

## 2303h Number Of Active User Program

### Function

Selects one of four possible user programs whose file names were stored earlier in object **2304<sub>h</sub>**.

### Object description

Index	2303 <sub>h</sub>
Object Name	Number Of Active User Program
Object Code	VARIABLE
Data type	UNSIGNED8
Savable	yes, category: application
Access	Read/write
PDO Mapping	RX - PDO
Admissible Values	
Specified Value	00 <sub>h</sub>
Firmware Version	FIR-v1426
Change History	



## Description

A change to the entry while a user program is being executed leads to the following procedure:

- The current program is stopped.
- The newly selected program is loaded.
- The newly loaded program is started.

## 2304h Table Of Available User Programs

### Function

The file names of the available user programs are stored here.

### Object description

Index	2304 <sub>h</sub>
Object Name	Table Of Available User Programs
Object Code	ARRAY
Data type	UNSIGNED32
Savable	yes, category: application
Firmware Version	FIR-v1426
Change History	

### Value description

Subindex	00 <sub>h</sub>
Name	Highest Sub-index Supported
Data type	UNSIGNED8
Access	Read only
PDO Mapping	No
Admissible Values	
Specified Value	08 <sub>h</sub>
Subindex	01 <sub>h</sub>
Name	Name Of User Program 1 UB
Data type	UNSIGNED32
Access	Read/write
PDO Mapping	No
Admissible Values	
Specified Value	00000000 <sub>h</sub>
Subindex	02 <sub>h</sub>
Name	Name Of User Program 1 LB
Data type	UNSIGNED32
Access	Read/write
PDO Mapping	No
Admissible Values	
Specified Value	00000000 <sub>h</sub>
Subindex	03 <sub>h</sub>
Name	Name Of User Program 2 UB
Data type	UNSIGNED32

Access	Read/write
PDO Mapping	No
Admissible Values	
Specified Value	00000000 <sub>h</sub>
Subindex	04 <sub>h</sub>
Name	Name Of User Program 2 LB
Data type	UNSIGNED32
Access	Read/write
PDO Mapping	No
Admissible Values	
Specified Value	00000000 <sub>h</sub>
Subindex	05 <sub>h</sub>
Name	Name Of User Program 3 UB
Data type	UNSIGNED32
Access	Read/write
PDO Mapping	No
Admissible Values	
Specified Value	00000000 <sub>h</sub>
Subindex	06 <sub>h</sub>
Name	Name Of User Program 3 LB
Data type	UNSIGNED32
Access	Read/write
PDO Mapping	No
Admissible Values	
Specified Value	00000000 <sub>h</sub>
Subindex	07 <sub>h</sub>
Name	Name Of User Program 4 UB
Data type	UNSIGNED32
Access	Read/write
PDO Mapping	No
Admissible Values	
Specified Value	00000000 <sub>h</sub>
Subindex	08 <sub>h</sub>
Name	Name Of User Program 4 LB
Data type	UNSIGNED32
Access	Read/write
PDO Mapping	No
Admissible Values	
Specified Value	00000000 <sub>h</sub>

### Description

For each user program, the name of the user program is contained in two consecutive subindices in ASCII code.

Program 1: subindices 1 and 2

Program 2: subindices 3 and 4

Program 3: subindices 5 and 6

Program 4: subindices 7 and 8

**Example:** Program 1 with the name `test.usr` is coded as follows:

`t = 74h`

`e = 65h`

`s = 73h`

Thus the two entries in subindices 1 and 2 are:

`74657374h, 00000000h`

For each user program, the name of the user program is contained in two consecutive subindices in ASCII code. The subindex with the designation UB (Upper Byte) contains the first four letters of the name, the subindex with LB (Lower Byte) the last four letters. Should the name have less than eight letters, the missing letters must be filled with zeros.

## 230Fh Uptime Seconds

### Function

This object contains the power-on hours since the last power-on in seconds.

#### Hinweis

This object won't get saved, the counting will start with "0" after power-on.

### Object description

Index	230F <sub>h</sub>
Object Name	Uptime Seconds
Object Code	VARIABLE
Data type	UNSIGNED32
Savable	No
Access	Read only
PDO Mapping	TX - PDO
Admissible Values	
Specified Value	00000000 <sub>h</sub>
Firmware Version	FIR-v1436
Change History	

## 2310h NanoJ Input Data Selection

### Function

Specifies the object dictionary entries that are copied into the input PDO mapping of the VMM program.

### Object description

Index	2310 <sub>h</sub>
Object Name	NanoJ Input Data Selection
Object Code	RECORD
Data type	PDO_MAPPING
Savable	yes, category: application

Firmware Version	FIR-v1426
Change History	Amount of subentries has changed from 2 to 17 Firmware Version FIR-v1436: Entry "Object Name" modified from "VMM Input Data Selection" to "NanoJ Input Data Selection".

### Value description

Subindex	00 <sub>h</sub>
Name	Highest Sub-index Supported
Data type	UNSIGNED8
Access	Read/write
PDO Mapping	No
Admissible Values	
Specified Value	00 <sub>h</sub>
Subindex	01 <sub>h</sub>
Name	Mapping #1
Data type	UNSIGNED32
Access	Read/write
PDO Mapping	No
Admissible Values	
Specified Value	00000000 <sub>h</sub>
Subindex	02 <sub>h</sub>
Name	Mapping #2
Data type	UNSIGNED32
Access	Read/write
PDO Mapping	No
Admissible Values	
Specified Value	00000000 <sub>h</sub>
Subindex	03 <sub>h</sub>
Name	Mapping #3
Data type	UNSIGNED32
Access	Read/write
PDO Mapping	No
Admissible Values	
Specified Value	00000000 <sub>h</sub>
Subindex	04 <sub>h</sub>
Name	Mapping #4
Data type	UNSIGNED32
Access	Read/write
PDO Mapping	No
Admissible Values	
Specified Value	00000000 <sub>h</sub>
Subindex	05 <sub>h</sub>
Name	Mapping #5

Data type	UNSIGNED32
Access	Read/write
PDO Mapping	No
Admissible Values	
Specified Value	00000000 <sub>h</sub>
Subindex	06 <sub>h</sub>
Name	Mapping #6
Data type	UNSIGNED32
Access	Read/write
PDO Mapping	No
Admissible Values	
Specified Value	00000000 <sub>h</sub>
Subindex	07 <sub>h</sub>
Name	Mapping #7
Data type	UNSIGNED32
Access	Read/write
PDO Mapping	No
Admissible Values	
Specified Value	00000000 <sub>h</sub>
Subindex	08 <sub>h</sub>
Name	Mapping #8
Data type	UNSIGNED32
Access	Read/write
PDO Mapping	No
Admissible Values	
Specified Value	00000000 <sub>h</sub>
Subindex	09 <sub>h</sub>
Name	Mapping #9
Data type	UNSIGNED32
Access	Read/write
PDO Mapping	No
Admissible Values	
Specified Value	00000000 <sub>h</sub>
Subindex	0A <sub>h</sub>
Name	Mapping #10
Data type	UNSIGNED32
Access	Read/write
PDO Mapping	No
Admissible Values	
Specified Value	00000000 <sub>h</sub>
Subindex	0B <sub>h</sub>
Name	Mapping #11
Data type	UNSIGNED32

Access	Read/write
PDO Mapping	No
Admissible Values	
Specified Value	00000000 <sub>h</sub>
Subindex	0C <sub>h</sub>
Name	Mapping #12
Data type	UNSIGNED32
Access	Read/write
PDO Mapping	No
Admissible Values	
Specified Value	00000000 <sub>h</sub>
Subindex	0D <sub>h</sub>
Name	Mapping #13
Data type	UNSIGNED32
Access	Read/write
PDO Mapping	No
Admissible Values	
Specified Value	00000000 <sub>h</sub>
Subindex	0E <sub>h</sub>
Name	Mapping #14
Data type	UNSIGNED32
Access	Read/write
PDO Mapping	No
Admissible Values	
Specified Value	00000000 <sub>h</sub>
Subindex	0F <sub>h</sub>
Name	Mapping #15
Data type	UNSIGNED32
Access	Read/write
PDO Mapping	No
Admissible Values	
Specified Value	00000000 <sub>h</sub>
Subindex	10 <sub>h</sub>
Name	Mapping #16
Data type	UNSIGNED32
Access	Read/write
PDO Mapping	No
Admissible Values	
Specified Value	00000000 <sub>h</sub>

### Description

Each subindex (1-16) describes a mapped object.

A mapping entry consists of four bytes made up according to the following graphic.

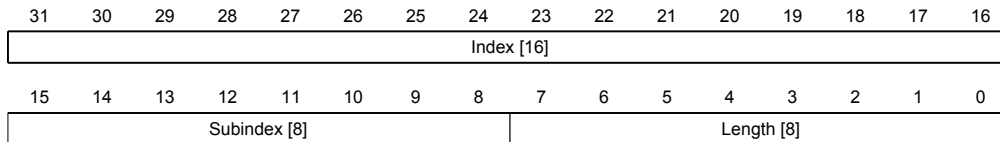

**Index [16]**

Contains the index of the object to be mapped

**Subindex [8]**

Contains the subindex of the object to be mapped

**Length [8]**

Contains the length of the object to be mapped in the bit unit.

## 2320h NanoJ Output Data Selection

**Function**

Specifies the object dictionary entries that are copied into the output PDO mapping of the VMM program after it has been executed.

**Object description**

Index	2320 <sub>h</sub>
Object Name	NanoJ Output Data Selection
Object Code	RECORD
Data type	PDO_MAPPING
Savable	yes, category: application
Firmware Version	FIR-v1426
Change History	Amount of subentries has changed from 2 to 17  Firmware Version FIR-v1436: Entry "Object Name" modified from "VMM Output Data Selection" to "NanoJ Output Data Selection".

**Value description**

Subindex	00 <sub>h</sub>
Name	Highest Sub-index Supported
Data type	UNSIGNED8
Access	Read/write
PDO Mapping	No
Admissible Values	
Specified Value	00 <sub>h</sub>
Subindex	01 <sub>h</sub>
Name	Mapping #1
Data type	UNSIGNED32
Access	Read/write
PDO Mapping	No
Admissible Values	
Specified Value	00000000 <sub>h</sub>

Subindex	02 <sub>h</sub>
Name	Mapping #2
Data type	UNSIGNED32
Access	Read/write
PDO Mapping	No
Admissible Values	
Specified Value	00000000 <sub>h</sub>
Subindex	03 <sub>h</sub>
Name	Mapping #3
Data type	UNSIGNED32
Access	Read/write
PDO Mapping	No
Admissible Values	
Specified Value	00000000 <sub>h</sub>
Subindex	04 <sub>h</sub>
Name	Mapping #4
Data type	UNSIGNED32
Access	Read/write
PDO Mapping	No
Admissible Values	
Specified Value	00000000 <sub>h</sub>
Subindex	05 <sub>h</sub>
Name	Mapping #5
Data type	UNSIGNED32
Access	Read/write
PDO Mapping	No
Admissible Values	
Specified Value	00000000 <sub>h</sub>
Subindex	06 <sub>h</sub>
Name	Mapping #6
Data type	UNSIGNED32
Access	Read/write
PDO Mapping	No
Admissible Values	
Specified Value	00000000 <sub>h</sub>
Subindex	07 <sub>h</sub>
Name	Mapping #7
Data type	UNSIGNED32
Access	Read/write
PDO Mapping	No
Admissible Values	
Specified Value	00000000 <sub>h</sub>
Subindex	08 <sub>h</sub>



Name	Mapping #8
Data type	UNSIGNED32
Access	Read/write
PDO Mapping	No
Admissible Values	
Specified Value	00000000 <sub>h</sub>
Subindex	09 <sub>h</sub>
Name	Mapping #9
Data type	UNSIGNED32
Access	Read/write
PDO Mapping	No
Admissible Values	
Specified Value	00000000 <sub>h</sub>
Subindex	0A <sub>h</sub>
Name	Mapping #10
Data type	UNSIGNED32
Access	Read/write
PDO Mapping	No
Admissible Values	
Specified Value	00000000 <sub>h</sub>
Subindex	0B <sub>h</sub>
Name	Mapping #11
Data type	UNSIGNED32
Access	Read/write
PDO Mapping	No
Admissible Values	
Specified Value	00000000 <sub>h</sub>
Subindex	0C <sub>h</sub>
Name	Mapping #12
Data type	UNSIGNED32
Access	Read/write
PDO Mapping	No
Admissible Values	
Specified Value	00000000 <sub>h</sub>
Subindex	0D <sub>h</sub>
Name	Mapping #13
Data type	UNSIGNED32
Access	Read/write
PDO Mapping	No
Admissible Values	
Specified Value	00000000 <sub>h</sub>
Subindex	0E <sub>h</sub>
Name	Mapping #14

Data type	UNSIGNED32
Access	Read/write
PDO Mapping	No
Admissible Values	
Specified Value	00000000 <sub>h</sub>
<hr/>	
Subindex	0F <sub>h</sub>
Name	Mapping #15
Data type	UNSIGNED32
Access	Read/write
PDO Mapping	No
Admissible Values	
Specified Value	00000000 <sub>h</sub>
<hr/>	
Subindex	10 <sub>h</sub>
Name	Mapping #16
Data type	UNSIGNED32
Access	Read/write
PDO Mapping	No
Admissible Values	
Specified Value	00000000 <sub>h</sub>

### Description

Each subindex (1-16) describes a mapped object.

A mapping entry consists of four bytes made up according to the following graphic.

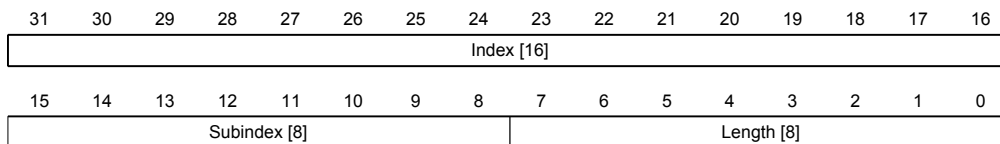

#### Index [16]

Contains the index of the object to be mapped

#### Subindex [8]

Contains the subindex of the object to be mapped

#### Length [8]

Contains the length of the object to be mapped in the bit unit.

## 2330h NanoJ In/output Data Selection

### Function

Specifies the object dictionary entries that are copied into the input PDO mapping of the VMM program and after its execution are copied back into the output PDO mapping.

### Object description

Index	2330 <sub>h</sub>
Object Name	NanoJ In/output Data Selection

Object Code	RECORD
Data type	PDO_MAPPING
Savable	yes, category: application
Firmware Version	FIR-v1426
Change History	Amount of subentries has changed from 2 to 17  Firmware Version FIR-v1436: Entry "Object Name" modified from "VMM In/output Data Selection" to "NanoJ In/output Data Selection".

### Value description

Subindex	00 <sub>h</sub>
Name	Highest Sub-index Supported
Data type	UNSIGNED8
Access	Read/write
PDO Mapping	No
Admissible Values	
Specified Value	00 <sub>h</sub>
Subindex	01 <sub>h</sub>
Name	Mapping #1
Data type	UNSIGNED32
Access	Read/write
PDO Mapping	No
Admissible Values	
Specified Value	00000000 <sub>h</sub>
Subindex	02 <sub>h</sub>
Name	Mapping #2
Data type	UNSIGNED32
Access	Read/write
PDO Mapping	No
Admissible Values	
Specified Value	00000000 <sub>h</sub>
Subindex	03 <sub>h</sub>
Name	Mapping #3
Data type	UNSIGNED32
Access	Read/write
PDO Mapping	No
Admissible Values	
Specified Value	00000000 <sub>h</sub>
Subindex	04 <sub>h</sub>
Name	Mapping #4
Data type	UNSIGNED32
Access	Read/write
PDO Mapping	No
Admissible Values	
Specified Value	00000000 <sub>h</sub>

Subindex	05 <sub>h</sub>
Name	Mapping #5
Data type	UNSIGNED32
Access	Read/write
PDO Mapping	No
Admissible Values	
Specified Value	00000000 <sub>h</sub>
Subindex	06 <sub>h</sub>
Name	Mapping #6
Data type	UNSIGNED32
Access	Read/write
PDO Mapping	No
Admissible Values	
Specified Value	00000000 <sub>h</sub>
Subindex	07 <sub>h</sub>
Name	Mapping #7
Data type	UNSIGNED32
Access	Read/write
PDO Mapping	No
Admissible Values	
Specified Value	00000000 <sub>h</sub>
Subindex	08 <sub>h</sub>
Name	Mapping #8
Data type	UNSIGNED32
Access	Read/write
PDO Mapping	No
Admissible Values	
Specified Value	00000000 <sub>h</sub>
Subindex	09 <sub>h</sub>
Name	Mapping #9
Data type	UNSIGNED32
Access	Read/write
PDO Mapping	No
Admissible Values	
Specified Value	00000000 <sub>h</sub>
Subindex	0A <sub>h</sub>
Name	Mapping #10
Data type	UNSIGNED32
Access	Read/write
PDO Mapping	No
Admissible Values	
Specified Value	00000000 <sub>h</sub>
Subindex	0B <sub>h</sub>

Name	Mapping #11
Data type	UNSIGNED32
Access	Read/write
PDO Mapping	No
Admissible Values	
Specified Value	00000000 <sub>h</sub>
Subindex	0C <sub>h</sub>
Name	Mapping #12
Data type	UNSIGNED32
Access	Read/write
PDO Mapping	No
Admissible Values	
Specified Value	00000000 <sub>h</sub>
Subindex	0D <sub>h</sub>
Name	Mapping #13
Data type	UNSIGNED32
Access	Read/write
PDO Mapping	No
Admissible Values	
Specified Value	00000000 <sub>h</sub>
Subindex	0E <sub>h</sub>
Name	Mapping #14
Data type	UNSIGNED32
Access	Read/write
PDO Mapping	No
Admissible Values	
Specified Value	00000000 <sub>h</sub>
Subindex	0F <sub>h</sub>
Name	Mapping #15
Data type	UNSIGNED32
Access	Read/write
PDO Mapping	No
Admissible Values	
Specified Value	00000000 <sub>h</sub>
Subindex	10 <sub>h</sub>
Name	Mapping #16
Data type	UNSIGNED32
Access	Read/write
PDO Mapping	No
Admissible Values	
Specified Value	00000000 <sub>h</sub>

### Description

Each subindex (1-16) describes a mapped object.

A mapping entry consists of four bytes made up according to the following graphic.

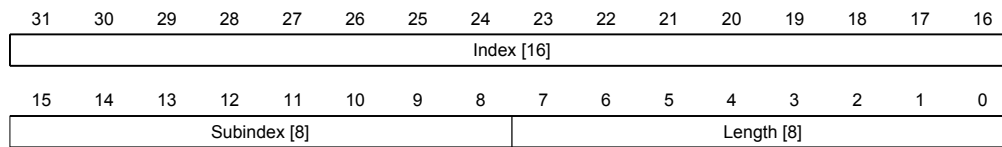

**Index [16]**

Contains the index of the object to be mapped

**Subindex [8]**

Contains the subindex of the object to be mapped

**Length [8]**

Contains the length of the object to be mapped in the bit unit.

## 2400h NanoJ Inputs

**Function**

Contains an array with 32 32-bit integer values that is not used within the firmware and is only used for communication with the user program via the field bus.

**Object description**

Index	2400 <sub>h</sub>
Object Name	NanoJ Inputs
Object Code	ARRAY
Data type	INTEGER32
Savable	No
Firmware Version	FIR-v1426
Change History	Amount of subentries has changed from 2 to 33  Firmware Version FIR-v1436: Entry "Object Name" modified from "VMM Inputs" to "NanoJ Inputs".

**Value description**

Subindex	00 <sub>h</sub>
Name	Highest Sub-index Supported
Data type	UNSIGNED8
Access	Read only
PDO Mapping	No
Admissible Values	
Specified Value	20 <sub>h</sub>
Subindex	01 <sub>h</sub>
Name	NanoJ Input 1#
Data type	INTEGER32
Access	Read/write
PDO Mapping	RX - PDO
Admissible Values	
Specified Value	00000000 <sub>h</sub>

Subindex	02 <sub>h</sub>
Name	NanoJ Input 2#
Data type	INTEGER32
Access	Read/write
PDO Mapping	RX - PDO
Admissible Values	
Specified Value	00000000 <sub>h</sub>
Subindex	03 <sub>h</sub>
Name	NanoJ Input 3#
Data type	INTEGER32
Access	Read/write
PDO Mapping	RX - PDO
Admissible Values	
Specified Value	00000000 <sub>h</sub>
Subindex	04 <sub>h</sub>
Name	NanoJ Input 4#
Data type	INTEGER32
Access	Read/write
PDO Mapping	RX - PDO
Admissible Values	
Specified Value	00000000 <sub>h</sub>
Subindex	05 <sub>h</sub>
Name	NanoJ Input 5#
Data type	INTEGER32
Access	Read/write
PDO Mapping	RX - PDO
Admissible Values	
Specified Value	00000000 <sub>h</sub>
Subindex	06 <sub>h</sub>
Name	NanoJ Input 6#
Data type	INTEGER32
Access	Read/write
PDO Mapping	RX - PDO
Admissible Values	
Specified Value	00000000 <sub>h</sub>
Subindex	07 <sub>h</sub>
Name	NanoJ Input 7#
Data type	INTEGER32
Access	Read/write
PDO Mapping	RX - PDO
Admissible Values	
Specified Value	00000000 <sub>h</sub>
Subindex	08 <sub>h</sub>

Name	NanoJ Input 8#
Data type	INTEGER32
Access	Read/write
PDO Mapping	RX - PDO
Admissible Values	
Specified Value	00000000 <sub>h</sub>
Subindex	09 <sub>h</sub>
Name	NanoJ Input 9#
Data type	INTEGER32
Access	Read/write
PDO Mapping	RX - PDO
Admissible Values	
Specified Value	00000000 <sub>h</sub>
Subindex	0A <sub>h</sub>
Name	NanoJ Input 10#
Data type	INTEGER32
Access	Read/write
PDO Mapping	RX - PDO
Admissible Values	
Specified Value	00000000 <sub>h</sub>
Subindex	0B <sub>h</sub>
Name	NanoJ Input 11#
Data type	INTEGER32
Access	Read/write
PDO Mapping	RX - PDO
Admissible Values	
Specified Value	00000000 <sub>h</sub>
Subindex	0C <sub>h</sub>
Name	NanoJ Input 12#
Data type	INTEGER32
Access	Read/write
PDO Mapping	RX - PDO
Admissible Values	
Specified Value	00000000 <sub>h</sub>
Subindex	0D <sub>h</sub>
Name	NanoJ Input 13#
Data type	INTEGER32
Access	Read/write
PDO Mapping	RX - PDO
Admissible Values	
Specified Value	00000000 <sub>h</sub>
Subindex	0E <sub>h</sub>
Name	NanoJ Input 14#



Data type	INTEGER32
Access	Read/write
PDO Mapping	RX - PDO
Admissible Values	
Specified Value	00000000 <sub>h</sub>
Subindex	0F <sub>h</sub>
Name	NanoJ Input 15#
Data type	INTEGER32
Access	Read/write
PDO Mapping	RX - PDO
Admissible Values	
Specified Value	00000000 <sub>h</sub>
Subindex	10 <sub>h</sub>
Name	NanoJ Input 16#
Data type	INTEGER32
Access	Read/write
PDO Mapping	RX - PDO
Admissible Values	
Specified Value	00000000 <sub>h</sub>
Subindex	11 <sub>h</sub>
Name	NanoJ Input 17#
Data type	INTEGER32
Access	Read/write
PDO Mapping	RX - PDO
Admissible Values	
Specified Value	00000000 <sub>h</sub>
Subindex	12 <sub>h</sub>
Name	NanoJ Input 18#
Data type	INTEGER32
Access	Read/write
PDO Mapping	RX - PDO
Admissible Values	
Specified Value	00000000 <sub>h</sub>
Subindex	13 <sub>h</sub>
Name	NanoJ Input 19#
Data type	INTEGER32
Access	Read/write
PDO Mapping	RX - PDO
Admissible Values	
Specified Value	00000000 <sub>h</sub>
Subindex	14 <sub>h</sub>
Name	NanoJ Input 20#
Data type	INTEGER32

Access	Read/write
PDO Mapping	RX - PDO
Admissible Values	
Specified Value	00000000 <sub>h</sub>
Subindex	15 <sub>h</sub>
Name	NanoJ Input 21#
Data type	INTEGER32
Access	Read/write
PDO Mapping	RX - PDO
Admissible Values	
Specified Value	00000000 <sub>h</sub>
Subindex	16 <sub>h</sub>
Name	NanoJ Input 22#
Data type	INTEGER32
Access	Read/write
PDO Mapping	RX - PDO
Admissible Values	
Specified Value	00000000 <sub>h</sub>
Subindex	17 <sub>h</sub>
Name	NanoJ Input 23#
Data type	INTEGER32
Access	Read/write
PDO Mapping	RX - PDO
Admissible Values	
Specified Value	00000000 <sub>h</sub>
Subindex	18 <sub>h</sub>
Name	NanoJ Input 24#
Data type	INTEGER32
Access	Read/write
PDO Mapping	RX - PDO
Admissible Values	
Specified Value	00000000 <sub>h</sub>
Subindex	19 <sub>h</sub>
Name	NanoJ Input 25#
Data type	INTEGER32
Access	Read/write
PDO Mapping	RX - PDO
Admissible Values	
Specified Value	00000000 <sub>h</sub>
Subindex	1A <sub>h</sub>
Name	NanoJ Input 26#
Data type	INTEGER32
Access	Read/write

PDO Mapping	RX - PDO
Admissible Values	
Specified Value	00000000 <sub>h</sub>
<hr/>	
Subindex	1B <sub>h</sub>
Name	NanoJ Input 27#
Data type	INTEGER32
Access	Read/write
PDO Mapping	RX - PDO
Admissible Values	
Specified Value	00000000 <sub>h</sub>
<hr/>	
Subindex	1C <sub>h</sub>
Name	NanoJ Input 28#
Data type	INTEGER32
Access	Read/write
PDO Mapping	RX - PDO
Admissible Values	
Specified Value	00000000 <sub>h</sub>
<hr/>	
Subindex	1D <sub>h</sub>
Name	NanoJ Input 29#
Data type	INTEGER32
Access	Read/write
PDO Mapping	RX - PDO
Admissible Values	
Specified Value	00000000 <sub>h</sub>
<hr/>	
Subindex	1E <sub>h</sub>
Name	NanoJ Input 30#
Data type	INTEGER32
Access	Read/write
PDO Mapping	RX - PDO
Admissible Values	
Specified Value	00000000 <sub>h</sub>
<hr/>	
Subindex	1F <sub>h</sub>
Name	NanoJ Input 31#
Data type	INTEGER32
Access	Read/write
PDO Mapping	RX - PDO
Admissible Values	
Specified Value	00000000 <sub>h</sub>
<hr/>	
Subindex	20 <sub>h</sub>
Name	NanoJ Input 32#
Data type	INTEGER32
Access	Read/write
PDO Mapping	RX - PDO

Admissible Values	
Specified Value	00000000 <sub>h</sub>

### Description

This is where the specified values, for example, can be transferred to the VMM program.

## 2410h NanoJ Init Parameters

### Function

This object works exactly like the object **2400<sub>h</sub>**, except that this object is persistent.

### Object description

Index	2410 <sub>h</sub>
Object Name	NanoJ Init Parameters
Object Code	ARRAY
Data type	INTEGER32
Savable	yes, category: application
Access	Read only
PDO Mapping	No
Admissible Values	
Specified Value	
Firmware Version	FIR-v1450
Change History	Firmware Version FIR-v1450: Entry "Data type" modified from "INTEGER32" to "UNSIGNED8".

### Value description

Subindex	00 <sub>h</sub>
Name	Highest Sub-index Supported
Data type	UNSIGNED8
Access	Read only
PDO Mapping	No
Admissible Values	
Specified Value	20 <sub>h</sub>

Subindex	01 <sub>h</sub>
Name	NanoJ Init Parameter 1#
Data type	INTEGER32
Access	Read/write
PDO Mapping	RX - PDO
Admissible Values	
Specified Value	00000000 <sub>h</sub>

Subindex	02 <sub>h</sub>
Name	NanoJ Init Parameter 2#
Data type	INTEGER32
Access	Read/write
PDO Mapping	RX - PDO

Admissible Values	
Specified Value	00000000 <sub>h</sub>
Subindex	03 <sub>h</sub>
Name	NanoJ Init Parameter 3#
Data type	INTEGER32
Access	Read/write
PDO Mapping	RX - PDO
Admissible Values	
Specified Value	00000000 <sub>h</sub>
Subindex	04 <sub>h</sub>
Name	NanoJ Init Parameter 4#
Data type	INTEGER32
Access	Read/write
PDO Mapping	RX - PDO
Admissible Values	
Specified Value	00000000 <sub>h</sub>
Subindex	05 <sub>h</sub>
Name	NanoJ Init Parameter 5#
Data type	INTEGER32
Access	Read/write
PDO Mapping	RX - PDO
Admissible Values	
Specified Value	00000000 <sub>h</sub>
Subindex	06 <sub>h</sub>
Name	NanoJ Init Parameter 6#
Data type	INTEGER32
Access	Read/write
PDO Mapping	RX - PDO
Admissible Values	
Specified Value	00000000 <sub>h</sub>
Subindex	07 <sub>h</sub>
Name	NanoJ Init Parameter 7#
Data type	INTEGER32
Access	Read/write
PDO Mapping	RX - PDO
Admissible Values	
Specified Value	00000000 <sub>h</sub>
Subindex	08 <sub>h</sub>
Name	NanoJ Init Parameter 8#
Data type	INTEGER32
Access	Read/write
PDO Mapping	RX - PDO
Admissible Values	

Specified Value	00000000 <sub>h</sub>
Subindex	09 <sub>h</sub>
Name	NanoJ Init Parameter 9#
Data type	INTEGER32
Access	Read/write
PDO Mapping	RX - PDO
Admissible Values	
Specified Value	00000000 <sub>h</sub>
Subindex	0A <sub>h</sub>
Name	NanoJ Init Parameter 10#
Data type	INTEGER32
Access	Read/write
PDO Mapping	RX - PDO
Admissible Values	
Specified Value	00000000 <sub>h</sub>
Subindex	0B <sub>h</sub>
Name	NanoJ Init Parameter 11#
Data type	INTEGER32
Access	Read/write
PDO Mapping	RX - PDO
Admissible Values	
Specified Value	00000000 <sub>h</sub>
Subindex	0C <sub>h</sub>
Name	NanoJ Init Parameter 12#
Data type	INTEGER32
Access	Read/write
PDO Mapping	RX - PDO
Admissible Values	
Specified Value	00000000 <sub>h</sub>
Subindex	0D <sub>h</sub>
Name	NanoJ Init Parameter 13#
Data type	INTEGER32
Access	Read/write
PDO Mapping	RX - PDO
Admissible Values	
Specified Value	00000000 <sub>h</sub>
Subindex	0E <sub>h</sub>
Name	NanoJ Init Parameter 14#
Data type	INTEGER32
Access	Read/write
PDO Mapping	RX - PDO
Admissible Values	
Specified Value	00000000 <sub>h</sub>

Subindex	0F <sub>h</sub>
Name	NanoJ Init Parameter 15#
Data type	INTEGER32
Access	Read/write
PDO Mapping	RX - PDO
Admissible Values	
Specified Value	00000000 <sub>h</sub>
Subindex	10 <sub>h</sub>
Name	NanoJ Init Parameter 16#
Data type	INTEGER32
Access	Read/write
PDO Mapping	RX - PDO
Admissible Values	
Specified Value	00000000 <sub>h</sub>
Subindex	11 <sub>h</sub>
Name	NanoJ Init Parameter 17#
Data type	INTEGER32
Access	Read/write
PDO Mapping	RX - PDO
Admissible Values	
Specified Value	00000000 <sub>h</sub>
Subindex	12 <sub>h</sub>
Name	NanoJ Init Parameter 18#
Data type	INTEGER32
Access	Read/write
PDO Mapping	RX - PDO
Admissible Values	
Specified Value	00000000 <sub>h</sub>
Subindex	13 <sub>h</sub>
Name	NanoJ Init Parameter 19#
Data type	INTEGER32
Access	Read/write
PDO Mapping	RX - PDO
Admissible Values	
Specified Value	00000000 <sub>h</sub>
Subindex	14 <sub>h</sub>
Name	NanoJ Init Parameter 20#
Data type	INTEGER32
Access	Read/write
PDO Mapping	RX - PDO
Admissible Values	
Specified Value	00000000 <sub>h</sub>
Subindex	15 <sub>h</sub>

Name	NanoJ Init Parameter 21#
Data type	INTEGER32
Access	Read/write
PDO Mapping	RX - PDO
Admissible Values	
Specified Value	00000000 <sub>h</sub>
Subindex	16 <sub>h</sub>
Name	NanoJ Init Parameter 22#
Data type	INTEGER32
Access	Read/write
PDO Mapping	RX - PDO
Admissible Values	
Specified Value	00000000 <sub>h</sub>
Subindex	17 <sub>h</sub>
Name	NanoJ Init Parameter 23#
Data type	INTEGER32
Access	Read/write
PDO Mapping	RX - PDO
Admissible Values	
Specified Value	00000000 <sub>h</sub>
Subindex	18 <sub>h</sub>
Name	NanoJ Init Parameter 24#
Data type	INTEGER32
Access	Read/write
PDO Mapping	RX - PDO
Admissible Values	
Specified Value	00000000 <sub>h</sub>
Subindex	19 <sub>h</sub>
Name	NanoJ Init Parameter 25#
Data type	INTEGER32
Access	Read/write
PDO Mapping	RX - PDO
Admissible Values	
Specified Value	00000000 <sub>h</sub>
Subindex	1A <sub>h</sub>
Name	NanoJ Init Parameter 26#
Data type	INTEGER32
Access	Read/write
PDO Mapping	RX - PDO
Admissible Values	
Specified Value	00000000 <sub>h</sub>
Subindex	1B <sub>h</sub>
Name	NanoJ Init Parameter 27#



Data type	INTEGER32
Access	Read/write
PDO Mapping	RX - PDO
Admissible Values	
Specified Value	00000000 <sub>h</sub>
Subindex	1C <sub>h</sub>
Name	NanoJ Init Parameter 28#
Data type	INTEGER32
Access	Read/write
PDO Mapping	RX - PDO
Admissible Values	
Specified Value	00000000 <sub>h</sub>
Subindex	1D <sub>h</sub>
Name	NanoJ Init Parameter 29#
Data type	INTEGER32
Access	Read/write
PDO Mapping	RX - PDO
Admissible Values	
Specified Value	00000000 <sub>h</sub>
Subindex	1E <sub>h</sub>
Name	NanoJ Init Parameter 30#
Data type	INTEGER32
Access	Read/write
PDO Mapping	RX - PDO
Admissible Values	
Specified Value	00000000 <sub>h</sub>
Subindex	1F <sub>h</sub>
Name	NanoJ Init Parameter 31#
Data type	INTEGER32
Access	Read/write
PDO Mapping	RX - PDO
Admissible Values	
Specified Value	00000000 <sub>h</sub>
Subindex	20 <sub>h</sub>
Name	NanoJ Init Parameter 32#
Data type	INTEGER32
Access	Read/write
PDO Mapping	RX - PDO
Admissible Values	
Specified Value	00000000 <sub>h</sub>

### Description

## 2500h NanoJ Outputs

### Function

Contains an array with 32 32-bit integer values that is not used within the firmware and is only used for communication with the user program via the field bus.

### Object description

Index	2500 <sub>h</sub>
Object Name	NanoJ Outputs
Object Code	ARRAY
Data type	INTEGER32
Savable	No
Firmware Version	FIR-v1426
Change History	Amount of subentries has changed from 2 to 33  Firmware Version FIR-v1436: Entry "Object Name" modified from "VMM Outputs" to "NanoJ Outputs".

### Value description

Subindex	00 <sub>h</sub>
Name	Highest Sub-index Supported
Data type	UNSIGNED8
Access	Read only
PDO Mapping	No
Admissible Values	
Specified Value	20 <sub>h</sub>

Subindex	01 <sub>h</sub>
Name	NanoJ Output 1#
Data type	INTEGER32
Access	Read/write
PDO Mapping	TX - PDO
Admissible Values	
Specified Value	00000000 <sub>h</sub>

Subindex	02 <sub>h</sub>
Name	NanoJ Output 2#
Data type	INTEGER32
Access	Read/write
PDO Mapping	TX - PDO
Admissible Values	
Specified Value	00000000 <sub>h</sub>

Subindex	03 <sub>h</sub>
Name	NanoJ Output 3#
Data type	INTEGER32
Access	Read/write
PDO Mapping	TX - PDO

Admissible Values	
Specified Value	00000000 <sub>h</sub>
Subindex	04 <sub>h</sub>
Name	NanoJ Output 4#
Data type	INTEGER32
Access	Read/write
PDO Mapping	TX - PDO
Admissible Values	
Specified Value	00000000 <sub>h</sub>
Subindex	05 <sub>h</sub>
Name	NanoJ Output 5#
Data type	INTEGER32
Access	Read/write
PDO Mapping	TX - PDO
Admissible Values	
Specified Value	00000000 <sub>h</sub>
Subindex	06 <sub>h</sub>
Name	NanoJ Output 6#
Data type	INTEGER32
Access	Read/write
PDO Mapping	TX - PDO
Admissible Values	
Specified Value	00000000 <sub>h</sub>
Subindex	07 <sub>h</sub>
Name	NanoJ Output 7#
Data type	INTEGER32
Access	Read/write
PDO Mapping	TX - PDO
Admissible Values	
Specified Value	00000000 <sub>h</sub>
Subindex	08 <sub>h</sub>
Name	NanoJ Output 8#
Data type	INTEGER32
Access	Read/write
PDO Mapping	TX - PDO
Admissible Values	
Specified Value	00000000 <sub>h</sub>
Subindex	09 <sub>h</sub>
Name	NanoJ Output 9#
Data type	INTEGER32
Access	Read/write
PDO Mapping	TX - PDO
Admissible Values	

Specified Value	00000000 <sub>h</sub>
Subindex	0A <sub>h</sub>
Name	NanoJ Output 10#
Data type	INTEGER32
Access	Read/write
PDO Mapping	TX - PDO
Admissible Values	
Specified Value	00000000 <sub>h</sub>
Subindex	0B <sub>h</sub>
Name	NanoJ Output 11#
Data type	INTEGER32
Access	Read/write
PDO Mapping	TX - PDO
Admissible Values	
Specified Value	00000000 <sub>h</sub>
Subindex	0C <sub>h</sub>
Name	NanoJ Output 12#
Data type	INTEGER32
Access	Read/write
PDO Mapping	TX - PDO
Admissible Values	
Specified Value	00000000 <sub>h</sub>
Subindex	0D <sub>h</sub>
Name	NanoJ Output 13#
Data type	INTEGER32
Access	Read/write
PDO Mapping	TX - PDO
Admissible Values	
Specified Value	00000000 <sub>h</sub>
Subindex	0E <sub>h</sub>
Name	NanoJ Output 14#
Data type	INTEGER32
Access	Read/write
PDO Mapping	TX - PDO
Admissible Values	
Specified Value	00000000 <sub>h</sub>
Subindex	0F <sub>h</sub>
Name	NanoJ Output 15#
Data type	INTEGER32
Access	Read/write
PDO Mapping	TX - PDO
Admissible Values	
Specified Value	00000000 <sub>h</sub>

Subindex	10 <sub>h</sub>
Name	NanoJ Output 16#
Data type	INTEGER32
Access	Read/write
PDO Mapping	TX - PDO
Admissible Values	
Specified Value	00000000 <sub>h</sub>
Subindex	11 <sub>h</sub>
Name	NanoJ Output 17#
Data type	INTEGER32
Access	Read/write
PDO Mapping	TX - PDO
Admissible Values	
Specified Value	00000000 <sub>h</sub>
Subindex	12 <sub>h</sub>
Name	NanoJ Output 18#
Data type	INTEGER32
Access	Read/write
PDO Mapping	TX - PDO
Admissible Values	
Specified Value	00000000 <sub>h</sub>
Subindex	13 <sub>h</sub>
Name	NanoJ Output 19#
Data type	INTEGER32
Access	Read/write
PDO Mapping	TX - PDO
Admissible Values	
Specified Value	00000000 <sub>h</sub>
Subindex	14 <sub>h</sub>
Name	NanoJ Output 20#
Data type	INTEGER32
Access	Read/write
PDO Mapping	TX - PDO
Admissible Values	
Specified Value	00000000 <sub>h</sub>
Subindex	15 <sub>h</sub>
Name	NanoJ Output 21#
Data type	INTEGER32
Access	Read/write
PDO Mapping	TX - PDO
Admissible Values	
Specified Value	00000000 <sub>h</sub>
Subindex	16 <sub>h</sub>

---

Name	NanoJ Output 22#
Data type	INTEGER32
Access	Read/write
PDO Mapping	TX - PDO
Admissible Values	
Specified Value	00000000 <sub>h</sub>

---

Subindex	17 <sub>h</sub>
Name	NanoJ Output 23#
Data type	INTEGER32
Access	Read/write
PDO Mapping	TX - PDO
Admissible Values	
Specified Value	00000000 <sub>h</sub>

---

Subindex	18 <sub>h</sub>
Name	NanoJ Output 24#
Data type	INTEGER32
Access	Read/write
PDO Mapping	TX - PDO
Admissible Values	
Specified Value	00000000 <sub>h</sub>

---

Subindex	19 <sub>h</sub>
Name	NanoJ Output 25#
Data type	INTEGER32
Access	Read/write
PDO Mapping	TX - PDO
Admissible Values	
Specified Value	00000000 <sub>h</sub>

---

Subindex	1A <sub>h</sub>
Name	NanoJ Output 26#
Data type	INTEGER32
Access	Read/write
PDO Mapping	TX - PDO
Admissible Values	
Specified Value	00000000 <sub>h</sub>

---

Subindex	1B <sub>h</sub>
Name	NanoJ Output 27#
Data type	INTEGER32
Access	Read/write
PDO Mapping	TX - PDO
Admissible Values	
Specified Value	00000000 <sub>h</sub>

---

Subindex	1C <sub>h</sub>
Name	NanoJ Output 28#

---

Data type	INTEGER32
Access	Read/write
PDO Mapping	TX - PDO
Admissible Values	
Specified Value	00000000 <sub>h</sub>
Subindex	1D <sub>h</sub>
Name	NanoJ Output 29#
Data type	INTEGER32
Access	Read/write
PDO Mapping	TX - PDO
Admissible Values	
Specified Value	00000000 <sub>h</sub>
Subindex	1E <sub>h</sub>
Name	NanoJ Output 30#
Data type	INTEGER32
Access	Read/write
PDO Mapping	TX - PDO
Admissible Values	
Specified Value	00000000 <sub>h</sub>
Subindex	1F <sub>h</sub>
Name	NanoJ Output 31#
Data type	INTEGER32
Access	Read/write
PDO Mapping	TX - PDO
Admissible Values	
Specified Value	00000000 <sub>h</sub>
Subindex	20 <sub>h</sub>
Name	NanoJ Output 32#
Data type	INTEGER32
Access	Read/write
PDO Mapping	TX - PDO
Admissible Values	
Specified Value	00000000 <sub>h</sub>

### Description

The VMM program can store results here that can then be read out via the field bus.

## 2600h NanoJ Debug Output

### Function

This object contains debug outputs for a user program.

### Object description

Index	2600 <sub>h</sub>
-------	-------------------

Object Name	NanoJ Debug Output
Object Code	ARRAY
Data type	UNSIGNED8
Savable	No
Firmware Version	FIR-v1426
Change History	Amount of subentries has changed from 2 to 65 Firmware Version FIR-v1436: Entry "Object Name" modified from "VMM Debug Output" to "NanoJ Debug Output".

### Value description

Subindex	00 <sub>h</sub>
Name	Highest Sub-index Supported
Data type	UNSIGNED8
Access	Read/write
PDO Mapping	No
Admissible Values	
Specified Value	00 <sub>h</sub>
Subindex	01 <sub>h</sub>
Name	Value #1
Data type	UNSIGNED8
Access	Read only
PDO Mapping	No
Admissible Values	
Specified Value	00 <sub>h</sub>
Subindex	02 <sub>h</sub>
Name	Value #2
Data type	UNSIGNED8
Access	Read only
PDO Mapping	No
Admissible Values	
Specified Value	00 <sub>h</sub>
Subindex	03 <sub>h</sub>
Name	Value #3
Data type	UNSIGNED8
Access	Read only
PDO Mapping	No
Admissible Values	
Specified Value	00 <sub>h</sub>
Subindex	04 <sub>h</sub>
Name	Value #4
Data type	UNSIGNED8
Access	Read only
PDO Mapping	No
Admissible Values	



Specified Value	00 <sub>h</sub>
Subindex	05 <sub>h</sub>
Name	Value #5
Data type	UNSIGNED8
Access	Read only
PDO Mapping	No
Admissible Values	
Specified Value	00 <sub>h</sub>
Subindex	06 <sub>h</sub>
Name	Value #6
Data type	UNSIGNED8
Access	Read only
PDO Mapping	No
Admissible Values	
Specified Value	00 <sub>h</sub>
Subindex	07 <sub>h</sub>
Name	Value #7
Data type	UNSIGNED8
Access	Read only
PDO Mapping	No
Admissible Values	
Specified Value	00 <sub>h</sub>
Subindex	08 <sub>h</sub>
Name	Value #8
Data type	UNSIGNED8
Access	Read only
PDO Mapping	No
Admissible Values	
Specified Value	00 <sub>h</sub>
Subindex	09 <sub>h</sub>
Name	Value #9
Data type	UNSIGNED8
Access	Read only
PDO Mapping	No
Admissible Values	
Specified Value	00 <sub>h</sub>
Subindex	0A <sub>h</sub>
Name	Value #10
Data type	UNSIGNED8
Access	Read only
PDO Mapping	No
Admissible Values	
Specified Value	00 <sub>h</sub>

Subindex	0B <sub>h</sub>
Name	Value #11
Data type	UNSIGNED8
Access	Read only
PDO Mapping	No
Admissible Values	
Specified Value	00 <sub>h</sub>
Subindex	0C <sub>h</sub>
Name	Value #12
Data type	UNSIGNED8
Access	Read only
PDO Mapping	No
Admissible Values	
Specified Value	00 <sub>h</sub>
Subindex	0D <sub>h</sub>
Name	Value #13
Data type	UNSIGNED8
Access	Read only
PDO Mapping	No
Admissible Values	
Specified Value	00 <sub>h</sub>
Subindex	0E <sub>h</sub>
Name	Value #14
Data type	UNSIGNED8
Access	Read only
PDO Mapping	No
Admissible Values	
Specified Value	00 <sub>h</sub>
Subindex	0F <sub>h</sub>
Name	Value #15
Data type	UNSIGNED8
Access	Read only
PDO Mapping	No
Admissible Values	
Specified Value	00 <sub>h</sub>
Subindex	10 <sub>h</sub>
Name	Value #16
Data type	UNSIGNED8
Access	Read only
PDO Mapping	No
Admissible Values	
Specified Value	00 <sub>h</sub>
Subindex	11 <sub>h</sub>

Name	Value #17
Data type	UNSIGNED8
Access	Read only
PDO Mapping	No
Admissible Values	
Specified Value	00 <sub>h</sub>
Subindex	12 <sub>h</sub>
Name	Value #18
Data type	UNSIGNED8
Access	Read only
PDO Mapping	No
Admissible Values	
Specified Value	00 <sub>h</sub>
Subindex	13 <sub>h</sub>
Name	Value #19
Data type	UNSIGNED8
Access	Read only
PDO Mapping	No
Admissible Values	
Specified Value	00 <sub>h</sub>
Subindex	14 <sub>h</sub>
Name	Value #20
Data type	UNSIGNED8
Access	Read only
PDO Mapping	No
Admissible Values	
Specified Value	00 <sub>h</sub>
Subindex	15 <sub>h</sub>
Name	Value #21
Data type	UNSIGNED8
Access	Read only
PDO Mapping	No
Admissible Values	
Specified Value	00 <sub>h</sub>
Subindex	16 <sub>h</sub>
Name	Value #22
Data type	UNSIGNED8
Access	Read only
PDO Mapping	No
Admissible Values	
Specified Value	00 <sub>h</sub>
Subindex	17 <sub>h</sub>
Name	Value #23

Data type	UNSIGNED8
Access	Read only
PDO Mapping	No
Admissible Values	
Specified Value	00 <sub>h</sub>
Subindex	18 <sub>h</sub>
Name	Value #24
Data type	UNSIGNED8
Access	Read only
PDO Mapping	No
Admissible Values	
Specified Value	00 <sub>h</sub>
Subindex	19 <sub>h</sub>
Name	Value #25
Data type	UNSIGNED8
Access	Read only
PDO Mapping	No
Admissible Values	
Specified Value	00 <sub>h</sub>
Subindex	1A <sub>h</sub>
Name	Value #26
Data type	UNSIGNED8
Access	Read only
PDO Mapping	No
Admissible Values	
Specified Value	00 <sub>h</sub>
Subindex	1B <sub>h</sub>
Name	Value #27
Data type	UNSIGNED8
Access	Read only
PDO Mapping	No
Admissible Values	
Specified Value	00 <sub>h</sub>
Subindex	1C <sub>h</sub>
Name	Value #28
Data type	UNSIGNED8
Access	Read only
PDO Mapping	No
Admissible Values	
Specified Value	00 <sub>h</sub>
Subindex	1D <sub>h</sub>
Name	Value #29
Data type	UNSIGNED8

Access	Read only
PDO Mapping	No
Admissible Values	
Specified Value	00 <sub>h</sub>
Subindex	1E <sub>h</sub>
Name	Value #30
Data type	UNSIGNED8
Access	Read only
PDO Mapping	No
Admissible Values	
Specified Value	00 <sub>h</sub>
Subindex	1F <sub>h</sub>
Name	Value #31
Data type	UNSIGNED8
Access	Read only
PDO Mapping	No
Admissible Values	
Specified Value	00 <sub>h</sub>
Subindex	20 <sub>h</sub>
Name	Value #32
Data type	UNSIGNED8
Access	Read only
PDO Mapping	No
Admissible Values	
Specified Value	00 <sub>h</sub>
Subindex	21 <sub>h</sub>
Name	Value #33
Data type	UNSIGNED8
Access	Read only
PDO Mapping	No
Admissible Values	
Specified Value	00 <sub>h</sub>
Subindex	22 <sub>h</sub>
Name	Value #34
Data type	UNSIGNED8
Access	Read only
PDO Mapping	No
Admissible Values	
Specified Value	00 <sub>h</sub>
Subindex	23 <sub>h</sub>
Name	Value #35
Data type	UNSIGNED8
Access	Read only

PDO Mapping	No
Admissible Values	
Specified Value	00 <sub>h</sub>
<hr/>	
Subindex	24 <sub>h</sub>
Name	Value #36
Data type	UNSIGNED8
Access	Read only
PDO Mapping	No
Admissible Values	
Specified Value	00 <sub>h</sub>
<hr/>	
Subindex	25 <sub>h</sub>
Name	Value #37
Data type	UNSIGNED8
Access	Read only
PDO Mapping	No
Admissible Values	
Specified Value	00 <sub>h</sub>
<hr/>	
Subindex	26 <sub>h</sub>
Name	Value #38
Data type	UNSIGNED8
Access	Read only
PDO Mapping	No
Admissible Values	
Specified Value	00 <sub>h</sub>
<hr/>	
Subindex	27 <sub>h</sub>
Name	Value #39
Data type	UNSIGNED8
Access	Read only
PDO Mapping	No
Admissible Values	
Specified Value	00 <sub>h</sub>
<hr/>	
Subindex	28 <sub>h</sub>
Name	Value #40
Data type	UNSIGNED8
Access	Read only
PDO Mapping	No
Admissible Values	
Specified Value	00 <sub>h</sub>
<hr/>	
Subindex	29 <sub>h</sub>
Name	Value #41
Data type	UNSIGNED8
Access	Read only
PDO Mapping	No

Admissible Values	
Specified Value	00 <sub>h</sub>
<hr/>	
Subindex	2A <sub>h</sub>
Name	Value #42
Data type	UNSIGNED8
Access	Read only
PDO Mapping	No
Admissible Values	
Specified Value	00 <sub>h</sub>
<hr/>	
Subindex	2B <sub>h</sub>
Name	Value #43
Data type	UNSIGNED8
Access	Read only
PDO Mapping	No
Admissible Values	
Specified Value	00 <sub>h</sub>
<hr/>	
Subindex	2C <sub>h</sub>
Name	Value #44
Data type	UNSIGNED8
Access	Read only
PDO Mapping	No
Admissible Values	
Specified Value	00 <sub>h</sub>
<hr/>	
Subindex	2D <sub>h</sub>
Name	Value #45
Data type	UNSIGNED8
Access	Read only
PDO Mapping	No
Admissible Values	
Specified Value	00 <sub>h</sub>
<hr/>	
Subindex	2E <sub>h</sub>
Name	Value #46
Data type	UNSIGNED8
Access	Read only
PDO Mapping	No
Admissible Values	
Specified Value	00 <sub>h</sub>
<hr/>	
Subindex	2F <sub>h</sub>
Name	Value #47
Data type	UNSIGNED8
Access	Read only
PDO Mapping	No
Admissible Values	

Specified Value	00 <sub>h</sub>
Subindex	30 <sub>h</sub>
Name	Value #48
Data type	UNSIGNED8
Access	Read only
PDO Mapping	No
Admissible Values	
Specified Value	00 <sub>h</sub>
Subindex	31 <sub>h</sub>
Name	Value #49
Data type	UNSIGNED8
Access	Read only
PDO Mapping	No
Admissible Values	
Specified Value	00 <sub>h</sub>
Subindex	32 <sub>h</sub>
Name	Value #50
Data type	UNSIGNED8
Access	Read only
PDO Mapping	No
Admissible Values	
Specified Value	00 <sub>h</sub>
Subindex	33 <sub>h</sub>
Name	Value #51
Data type	UNSIGNED8
Access	Read only
PDO Mapping	No
Admissible Values	
Specified Value	00 <sub>h</sub>
Subindex	34 <sub>h</sub>
Name	Value #52
Data type	UNSIGNED8
Access	Read only
PDO Mapping	No
Admissible Values	
Specified Value	00 <sub>h</sub>
Subindex	35 <sub>h</sub>
Name	Value #53
Data type	UNSIGNED8
Access	Read only
PDO Mapping	No
Admissible Values	
Specified Value	00 <sub>h</sub>



Subindex	36 <sub>h</sub>
Name	Value #54
Data type	UNSIGNED8
Access	Read only
PDO Mapping	No
Admissible Values	
Specified Value	00 <sub>h</sub>
Subindex	37 <sub>h</sub>
Name	Value #55
Data type	UNSIGNED8
Access	Read only
PDO Mapping	No
Admissible Values	
Specified Value	00 <sub>h</sub>
Subindex	38 <sub>h</sub>
Name	Value #56
Data type	UNSIGNED8
Access	Read only
PDO Mapping	No
Admissible Values	
Specified Value	00 <sub>h</sub>
Subindex	39 <sub>h</sub>
Name	Value #57
Data type	UNSIGNED8
Access	Read only
PDO Mapping	No
Admissible Values	
Specified Value	00 <sub>h</sub>
Subindex	3A <sub>h</sub>
Name	Value #58
Data type	UNSIGNED8
Access	Read only
PDO Mapping	No
Admissible Values	
Specified Value	00 <sub>h</sub>
Subindex	3B <sub>h</sub>
Name	Value #59
Data type	UNSIGNED8
Access	Read only
PDO Mapping	No
Admissible Values	
Specified Value	00 <sub>h</sub>
Subindex	3C <sub>h</sub>

Name	Value #60
Data type	UNSIGNED8
Access	Read only
PDO Mapping	No
Admissible Values	
Specified Value	00 <sub>h</sub>
Subindex	3D <sub>h</sub>
Name	Value #61
Data type	UNSIGNED8
Access	Read only
PDO Mapping	No
Admissible Values	
Specified Value	00 <sub>h</sub>
Subindex	3E <sub>h</sub>
Name	Value #62
Data type	UNSIGNED8
Access	Read only
PDO Mapping	No
Admissible Values	
Specified Value	00 <sub>h</sub>
Subindex	3F <sub>h</sub>
Name	Value #63
Data type	UNSIGNED8
Access	Read only
PDO Mapping	No
Admissible Values	
Specified Value	00 <sub>h</sub>
Subindex	40 <sub>h</sub>
Name	Value #64
Data type	UNSIGNED8
Access	Read only
PDO Mapping	No
Admissible Values	
Specified Value	00 <sub>h</sub>

### Description

The VMM program stores the debug outputs here that have been called up with the function `VmmDebugOutputString()`, `VmmDebugOutputInt()`, and suchlike. A detailed description of the debug output can be found in the "**Debug output**" sub-section of the "**Programming with NanoJ**" section.

## 3202h Motor Drive Submode Select

### Function

Controls the control mode such as the closed loop /open loop changeover and whether velocity mode is simulated via the S control, or whether it operates with a true v control in the closed loop.

### Object description

Index	3202 <sub>h</sub>
Object Name	Motor Drive Submode Select
Object Code	VARIABLE
Data type	UNSIGNED32
Savable	yes, category: application
Access	Read/write
PDO Mapping	RX - PDO
Admissible Values	
Specified Value	00000000 <sub>h</sub>
Firmware Version	FIR-v1426
Change History	

### Description

31	30	29	28	27	26	25	24	23	22	21	20	19	18	17	16
15	14	13	12	11	10	9	8	7	6	5	4	3	2	1	0
								Ferr	BLDC	Torque		CurRed	Brake	VoS	CL/OL

#### CL/OL

Switchover between open loop and closed loop

- Value = "0": Open loop
- Value = "1": Closed loop

#### VoS

Value = "1": Simulate v-control via an S ramp

#### Brake

Value = "1": Switch on the brake controller

#### CurRed (Current Reduction)

Value = "1": Current reduction activated in open loop

#### Torque

Only active in **Profile Torque Mode**

Value = "1": M-control is active, otherwise a V-control is superimposed

#### BLDC

Value = "1": Motor type "BLDC" (brushless DC motor)

#### Ferr (Following Error)

Value = "1": A "following error" triggers a fault with an associated response (see object **605E<sub>h</sub>**)

## 320Ah Motor Drive Sensor Display Open Loop

### Function

It can be used to change the source for objects **6044<sub>h</sub>** and **6064<sub>h</sub>** in open loop mode.

### Object description

Index	320A <sub>h</sub>
Object Name	Motor Drive Sensor Display Open Loop
Object Code	ARRAY
Data type	INTEGER32
Savable	yes, category: application
Firmware Version	FIR-v1426
Change History	

### Value description

Subindex	00 <sub>h</sub>
Name	Highest Sub-index Supported
Data type	UNSIGNED8
Access	Read only
PDO Mapping	No
Admissible Values	
Specified Value	04 <sub>h</sub>

Subindex	01 <sub>h</sub>
Name	Commutation
Data type	INTEGER32
Access	Read/write
PDO Mapping	No
Admissible Values	
Specified Value	00000000 <sub>h</sub>

Subindex	02 <sub>h</sub>
Name	Torque
Data type	INTEGER32
Access	Read/write
PDO Mapping	No
Admissible Values	
Specified Value	00000000 <sub>h</sub>

Subindex	03 <sub>h</sub>
Name	Velocity
Data type	INTEGER32
Access	Read/write
PDO Mapping	No
Admissible Values	
Specified Value	FFFFFFFF <sub>h</sub>

Subindex	04 <sub>h</sub>
----------	-----------------

Name	Position
Data type	INTEGER32
Access	Read/write
PDO Mapping	No
Admissible Values	
Specified Value	FFFFFFFF <sub>h</sub>

### Description

The following subindices haven a meaning:

- 01<sub>h</sub>: Unused
- 02<sub>h</sub>: Unused
- 03<sub>h</sub>: Changes the source of object **6044<sub>h</sub>**:
  - Value = "-1": The internally calculated value is entered in object **6044<sub>h</sub>**
  - Value = "0": The value is kept at 0
  - Value = "1": The encoder value is entered in object **6044<sub>h</sub>**
- 04<sub>h</sub>: Changes the source of object **6064<sub>h</sub>**:
  - Value = "-1": The internally calculated value is entered in object **6064<sub>h</sub>**
  - Value = "0": The value is kept at 0
  - Value = "1": The encoder value is entered in object **6064<sub>h</sub>**

## 320Bh Motor Drive Sensor Display Closed Loop

### Function

It can be used to change the source for objects **6044<sub>h</sub>** and **6064<sub>h</sub>** in closed loop mode.

### Object description

Index	320B <sub>h</sub>
Object Name	Motor Drive Sensor Display Closed Loop
Object Code	ARRAY
Data type	INTEGER32
Savable	yes, category: application
Firmware Version	FIR-v1426
Change History	

### Value description

Subindex	00 <sub>h</sub>
Name	Highest Sub-index Supported
Data type	UNSIGNED8
Access	Read only
PDO Mapping	No
Admissible Values	
Specified Value	04 <sub>h</sub>

Subindex	01 <sub>h</sub>
Name	Commutation
Data type	INTEGER32
Access	Read/write

PDO Mapping	No
Admissible Values	
Specified Value	00000000 <sub>h</sub>
<hr/>	
Subindex	02 <sub>h</sub>
Name	Torque
Data type	INTEGER32
Access	Read/write
PDO Mapping	No
Admissible Values	
Specified Value	00000000 <sub>h</sub>
<hr/>	
Subindex	03 <sub>h</sub>
Name	Velocity
Data type	INTEGER32
Access	Read/write
PDO Mapping	No
Admissible Values	
Specified Value	00000001 <sub>h</sub>
<hr/>	
Subindex	04 <sub>h</sub>
Name	Position
Data type	INTEGER32
Access	Read/write
PDO Mapping	No
Admissible Values	
Specified Value	00000001 <sub>h</sub>

### Description

The following subindices haven a meaning:

- 01<sub>h</sub>: Unused
- 02<sub>h</sub>: Unused
- 03<sub>h</sub>: Changes the source of object **6044<sub>h</sub>**:
  - Value = "-1": The internally calculated value is entered in object **6044<sub>h</sub>**
  - Value = "0": The value is kept at 0
  - Value = "1": The encoder value is entered in object **6044<sub>h</sub>**
- 04<sub>h</sub>: Changes the source of object **6064<sub>h</sub>**:
  - Value = "-1": The internally calculated value is entered in object **6064<sub>h</sub>**
  - Value = "0": The value is kept at 0
  - Value = "1": The encoder value is entered in object **6064<sub>h</sub>**

### 3210h Motor Drive Parameter Set

#### Function

Contains the P and I values of the current, distance and position controllers for the open loop (only the current controller is activated) and closed loop.

### Object description

Index	3210 <sub>h</sub>
Object Name	Motor Drive Parameter Set
Object Code	ARRAY
Data type	INTEGER32
Savable	yes, category: application
Firmware Version	FIR-v1426
Change History	Amount of subentries has changed from 9 to 11

### Value description

Subindex	00 <sub>h</sub>
Name	Highest Sub-index Supported
Data type	UNSIGNED8
Access	Read only
PDO Mapping	No
Admissible Values	
Specified Value	0A <sub>h</sub>
Subindex	01 <sub>h</sub>
Name	S_P
Data type	INTEGER32
Access	Read/write
PDO Mapping	No
Admissible Values	
Specified Value	00000800 <sub>h</sub>
Subindex	02 <sub>h</sub>
Name	S_I
Data type	INTEGER32
Access	Read/write
PDO Mapping	No
Admissible Values	
Specified Value	00000000 <sub>h</sub>
Subindex	03 <sub>h</sub>
Name	V_P
Data type	INTEGER32
Access	Read/write
PDO Mapping	No
Admissible Values	
Specified Value	00002EE0 <sub>h</sub>
Subindex	04 <sub>h</sub>
Name	V_I
Data type	INTEGER32
Access	Read/write
PDO Mapping	No

Admissible Values	
Specified Value	0000001E <sub>h</sub>
Subindex	05 <sub>h</sub>
Name	Id_P
Data type	INTEGER32
Access	Read/write
PDO Mapping	No
Admissible Values	
Specified Value	000668A0 <sub>h</sub>
Subindex	06 <sub>h</sub>
Name	Id_I
Data type	INTEGER32
Access	Read/write
PDO Mapping	No
Admissible Values	
Specified Value	00002EE0 <sub>h</sub>
Subindex	07 <sub>h</sub>
Name	Iq_P
Data type	INTEGER32
Access	Read/write
PDO Mapping	No
Admissible Values	
Specified Value	000668A0 <sub>h</sub>
Subindex	08 <sub>h</sub>
Name	Iq_I
Data type	INTEGER32
Access	Read/write
PDO Mapping	No
Admissible Values	
Specified Value	00002EE0 <sub>h</sub>
Subindex	09 <sub>h</sub>
Name	I_P
Data type	INTEGER32
Access	Read/write
PDO Mapping	No
Admissible Values	
Specified Value	0003A980 <sub>h</sub>
Subindex	0A <sub>h</sub>
Name	I_I
Data type	INTEGER32
Access	Read/write
PDO Mapping	No
Admissible Values	



Specified Value                      0000AFC8<sub>h</sub>

**Description**

- Subindex 00<sub>h</sub>: Number of entries
- Subindex 01<sub>h</sub>: Proportional value of the S control
- Subindex 02<sub>h</sub>: Integral value of the S control
- Subindex 03<sub>h</sub>: Proportional value of the V control
- Subindex 04<sub>h</sub>: Integral value of the V control
- Subindex 05<sub>h</sub>: (Closed Loop) Proportional value of the current controller for the field-forming component
- Subindex 06<sub>h</sub>: (Closed Loop) Integral value of the current controller for the field-forming component
- Subindex 07<sub>h</sub>: (Closed Loop) Proportional value of the current controller for the torque-forming component
- Subindex 08<sub>h</sub>: (Closed Loop) Integral value of the current controller for the torque-forming component
- Subindex 09<sub>h</sub>: (Open Loop) Proportional value of the current controller for the torque-forming component
- Subindex 0A<sub>h</sub>: (Open Loop) Integral value of the current controller for the torque-forming component

**3212h Motor Drive Flags**

**Function**

This object determines, whether the output voltage for the motor is active in state "switched on" of the DS 402 Statemachine or not.

**Object description**

Index	3212 <sub>h</sub>
Object Name	Motor Drive Flags
Object Code	ARRAY
Data type	INTEGER8
Savable	yes, category: application
Access	Read only
PDO Mapping	No
Admissible Values	
Specified Value	
Firmware Version	FIR-v1450
Change History	Firmware Version FIR-v1450: Entry "Data type" modified from "INTEGER8" to "UNSIGNED8".

**Value description**

Subindex	00 <sub>h</sub>
Name	Highest Sub-index Supported
Data type	UNSIGNED8
Access	Read only
PDO Mapping	No
Admissible Values	
Specified Value	01 <sub>h</sub>

---

Subindex	01 <sub>h</sub>
----------	-----------------

Name	Enable Legacy Power Mode
Data type	INTEGER8
Access	Read/write
PDO Mapping	No
Admissible Values	
Specified Value	00 <sub>h</sub>

### Description

For the subindex 01<sub>h</sub> are valid values:

- Value = "0": The output voltage for the motor (PWM) at state "Switched On" of "**DS402 Power State machine**" is set fix to 50%, no holding torque is build up.
- Value = "1": The output voltage for the motor (PWM) at state "Switched On" of "**DS402 Power State machine**" is controlled active by the controller, holding torque is build up. The motor will kept still.

## 3220h Analog Inputs

### Function

Shows the present values of the analog inputs in [digits].

Object **3221<sub>h</sub>** allows the respective analog input to be configured as a current or voltage input.

### Object description

Index	3220 <sub>h</sub>
Object Name	Analog Inputs
Object Code	ARRAY
Data type	INTEGER16
Savable	No
Firmware Version	FIR-v1426
Change History	

### Value description

Subindex	00 <sub>h</sub>
Name	Highest Sub-index Supported
Data type	UNSIGNED8
Access	Read only
PDO Mapping	No
Admissible Values	
Specified Value	02 <sub>h</sub>

Subindex	01 <sub>h</sub>
Name	Analogue Input 1
Data type	INTEGER16
Access	Read only
PDO Mapping	TX - PDO
Admissible Values	
Specified Value	0000 <sub>h</sub>

Subindex	02 <sub>h</sub>
----------	-----------------

Name	Analogue Input 2
Data type	INTEGER16
Access	Read only
PDO Mapping	TX - PDO
Admissible Values	
Specified Value	0000 <sub>h</sub>

**Description**

Formulas for conversion of [digits] into the respective unit:

- Voltage input: x digits \* 10 V / 1024 digits
- Current input: x digits \* 20 mA/1024 digits

**3221h Analogue Inputs Control**

**Function**

This object can be used to change an analog input from voltage to current measurement.

**Object description**

Index	3221 <sub>h</sub>
Object Name	Analogue Inputs Control
Object Code	VARIABLE
Data type	INTEGER32
Savable	yes, category: application
Access	Read/write
PDO Mapping	No
Admissible Values	
Specified Value	00000000 <sub>h</sub>
Firmware Version	FIR-v1426
Change History	

**Description**

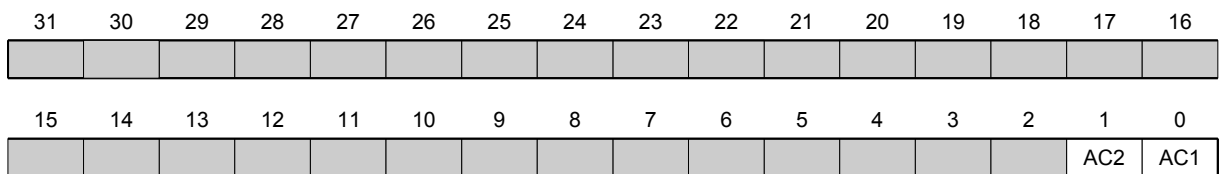

In general: If a bit is set to 0, the analog input measures the voltage; if the bit is set to 1, the current is measured.

**AC1**

Setting for analog input 1

**AC2**

Setting for analog input 2

## 3225h Analogue Inputs Switches

### Function

This object contains either the adjusted CANopen nodeID of the rotary switch or the positions of the DIP switches

### Object description

Index	3225 <sub>h</sub>
Object Name	Analogue Inputs Switches
Object Code	ARRAY
Data type	UNSIGNED16
Savable	No
Access	Read only
PDO Mapping	No
Admissible Values	
Specified Value	
Firmware Version	FIR-v1436
Change History	Firmware Version FIR-v1436: Entry "Data type" modified from "UNSIGNED16" to "UNSIGNED8".  Firmware Version FIR-v1436: Table entry "PDO Mapping" at subindex 01 modified from "RX - PDO" to "TX - PDO".

### Value description

Subindex	00 <sub>h</sub>
Name	Highest Sub-index Supported
Data type	UNSIGNED8
Access	Read only
PDO Mapping	No
Admissible Values	
Specified Value	01 <sub>h</sub>
Subindex	01 <sub>h</sub>
Name	Analogue Input Switch1
Data type	UNSIGNED16
Access	Read only
PDO Mapping	TX - PDO
Admissible Values	
Specified Value	0000 <sub>h</sub>

### Description

In subindex 1 the nodeID of the rotary switch(es) is registered if a CANopen interface is available to the controller.

When a DIP-Switch is fitted to the controller, the positions of the DIP switches are stored in subindex 1. Bit 0 accords the switch 1, the value of the bit is "1" if the switch is set to "on".

## 3240h Digital Inputs Control

### Function

This object can be used to manipulate the digital inputs as described in the "**Digital inputs and outputs**" section. For all the following subindices, bit 0 pertains to digital input 1, bit 1 pertains to input 2, etc.

### Object description

Index	3240 <sub>h</sub>
Object Name	Digital Inputs Control
Object Code	ARRAY
Data type	UNSIGNED32
Savable	yes, category: application
Firmware Version	FIR-v1426
Change History	Version 1.0.3: Subindex 01 <sub>h</sub> : The "Name" entry was changed from "Special Function Disable" to "Special Function Enable"

### Value description

Subindex	00 <sub>h</sub>
Name	Highest Sub-index Supported
Data type	UNSIGNED8
Access	Read only
PDO Mapping	No
Admissible Values	
Specified Value	07 <sub>h</sub>

Subindex	01 <sub>h</sub>
Name	Special Function Enable
Data type	UNSIGNED32
Access	Read/write
PDO Mapping	RX - PDO
Admissible Values	
Specified Value	00000000 <sub>h</sub>

Subindex	02 <sub>h</sub>
Name	Function Inverted
Data type	UNSIGNED32
Access	Read/write
PDO Mapping	RX - PDO
Admissible Values	
Specified Value	00000000 <sub>h</sub>

Subindex	03 <sub>h</sub>
Name	Force Enable
Data type	UNSIGNED32
Access	Read/write
PDO Mapping	RX - PDO

Admissible Values	
Specified Value	00000000 <sub>h</sub>
<hr/>	
Subindex	04 <sub>h</sub>
Name	Force Value
Data type	UNSIGNED32
Access	Read/write
PDO Mapping	RX - PDO
Admissible Values	
Specified Value	00000000 <sub>h</sub>
<hr/>	
Subindex	05 <sub>h</sub>
Name	Raw Value
Data type	UNSIGNED32
Access	Read/write
PDO Mapping	RX - PDO
Admissible Values	
Specified Value	00000000 <sub>h</sub>
<hr/>	
Subindex	06 <sub>h</sub>
Name	Input Range Select
Data type	UNSIGNED32
Access	Read/write
PDO Mapping	RX - PDO
Admissible Values	
Specified Value	00000000 <sub>h</sub>
<hr/>	
Subindex	07 <sub>h</sub>
Name	Differential Select
Data type	UNSIGNED32
Access	Read/write
PDO Mapping	RX - PDO
Admissible Values	
Specified Value	00000000 <sub>h</sub>

## Description

The subentries have the following function:

- 01<sub>h</sub>: This subindex switches on the special functions of the respective input if the bit has the value "1".
- 02<sub>h</sub>: This subindex inverts the logic of an input if the respective input has the value "1".
- 03<sub>h</sub>: This subindex forces an input value if the bit has the value "1". An input with a forced value is always set to the value entered in subentry 4<sub>h</sub> regardless of the applied voltage level.
- 04<sub>h</sub>: This subindex specifies the input value to be forced.
- 05<sub>h</sub>: This subindex always contains the read, unmodified input value.
- 06<sub>h</sub>: This subindex switches the switching thresholds between 5 V (value "0") and 24 V (value "1") if the input supports this function.
- 07<sub>h</sub>: This subindex switches the inputs from a single ended (value "0") to differential (value "1") input if the inputs support this function.

## 3250h Digital Outputs Control

### Function

This object can be used to control the digital outputs as described in the "**Digital inputs and outputs**" section. For all the following subindices, bit 0 pertains to digital output 1, bit 1 pertains to output 2, etc.

### Object description

Index	3250 <sub>h</sub>
Object Name	Digital Outputs Control
Object Code	ARRAY
Data type	UNSIGNED32
Savable	yes, category: application
Firmware Version	FIR-v1426
Change History	Firmware Version FIR-v1426: Subindex 01 <sub>h</sub> : Entry "Name" changed from "Special Function Disable" auf "Special Function Enable"  Firmware Version FIR-v1446: Entry "Name" modified from "Special Function Enable" to "No Function".

### Value description

Subindex	00 <sub>h</sub>
Name	Highest Sub-index Supported
Data type	UNSIGNED8
Access	Read only
PDO Mapping	No
Admissible Values	
Specified Value	05 <sub>h</sub>

Subindex	01 <sub>h</sub>
Name	No Function
Data type	UNSIGNED32
Access	Read/write
PDO Mapping	RX - PDO
Admissible Values	
Specified Value	00000000 <sub>h</sub>

Subindex	02 <sub>h</sub>
Name	Function Inverted
Data type	UNSIGNED32
Access	Read/write
PDO Mapping	RX - PDO
Admissible Values	
Specified Value	00000000 <sub>h</sub>

Subindex	03 <sub>h</sub>
Name	Force Enable
Data type	UNSIGNED32
Access	Read/write

PDO Mapping	RX - PDO
Admissible Values	
Specified Value	00000000 <sub>h</sub>
Subindex	04 <sub>h</sub>
Name	Force Value
Data type	UNSIGNED32
Access	Read/write
PDO Mapping	RX - PDO
Admissible Values	
Specified Value	00000000 <sub>h</sub>
Subindex	05 <sub>h</sub>
Name	Raw Value
Data type	UNSIGNED32
Access	Read/write
PDO Mapping	RX - PDO
Admissible Values	
Specified Value	00000000 <sub>h</sub>

### Description

The subentries have the following function:

- 01<sub>h</sub>: No function.
- 02<sub>h</sub>: This subindex inverts the logic (from opener logic to closer logic)
- 03<sub>h</sub>: This subindex forces an output value if the bit has the value "1". The level of the output is defined in subindex 4<sub>h</sub>.
- 04<sub>h</sub>: This subindex defines the level to be applied to the output. The value "0" delivers a logical low level at the digital output; value "1" delivers a logical high level.
- 05<sub>h</sub>: In this subindex, the bit combination applied to the outputs is stored.

## 3320h Read Analogue Input

### Function

Displays the momentary value of the analogue inputs in user units.

### Object description

Index	3320 <sub>h</sub>
Object Name	Read Analogue Input
Object Code	ARRAY
Data type	INTEGER32
Savable	No
Access	Read only
PDO Mapping	No
Admissible Values	
Specified Value	
Firmware Version	FIR-v1426
Change History	



### Value description

Subindex	00 <sub>h</sub>
Name	Number Of Analogue Inputs
Data type	UNSIGNED8
Access	Read only
PDO Mapping	No
Admissible Values	
Specified Value	02 <sub>h</sub>
Subindex	01 <sub>h</sub>
Name	Analogue Input 1
Data type	INTEGER32
Access	Read only
PDO Mapping	TX - PDO
Admissible Values	
Specified Value	00000000 <sub>h</sub>
Subindex	02 <sub>h</sub>
Name	Analogue Input 2
Data type	INTEGER32
Access	Read only
PDO Mapping	TX - PDO
Admissible Values	
Specified Value	00000000 <sub>h</sub>

### Description

The user units are combined from offset ( **3321<sub>h</sub>**) and pre scaling value ( **3322<sub>h</sub>**). When both objects are left to the default settings, the value in **3320<sub>h</sub>** is given in the unit "ADC digits".

Formulars for converting from digits to the particular unig:

Voltage input:  $(x \text{ digits} - 512 \text{ digits}) * 20 \text{ V} / 1024 \text{ digits}$

Current input:  $x \text{ digits} * 20 \text{ mA} / 1024 \text{ digits}$

For the sub entries applies:

- Subindex 00<sub>h</sub>: Amount of analogue inputs
- Subindex 01<sub>h</sub>: Analogue value 1
- Subindex 02<sub>h</sub>: Analogue value 2

## 3321h Analogue Input Offset

### Function

Offset that is added to the read-in analog value ( **3320<sub>h</sub>**) before division with the divider from object **3322<sub>h</sub>** is carried out.

### Object description

Index	3321 <sub>h</sub>
Object Name	Analogue Input Offset
Object Code	ARRAY
Data type	INTEGER32

Savable	yes, category: application
Firmware Version	FIR-v1426
Change History	

### Value description

Subindex	00 <sub>h</sub>
Name	Number Of Analogue Inputs
Data type	UNSIGNED8
Access	Read only
PDO Mapping	No
Admissible Values	
Specified Value	02 <sub>h</sub>
Subindex	01 <sub>h</sub>
Name	Analogue Input 1
Data type	INTEGER32
Access	Read/write
PDO Mapping	No
Admissible Values	
Specified Value	00000000 <sub>h</sub>
Subindex	02 <sub>h</sub>
Name	Analogue Input 2
Data type	INTEGER32
Access	Read/write
PDO Mapping	No
Admissible Values	
Specified Value	00000000 <sub>h</sub>

### Description

- Subindex 00<sub>h</sub>: Number of offsets
- Subindex 01<sub>h</sub>: Offset for analog input 1
- Subindex 02<sub>h</sub>: Offset for analog input 2

## 3322h Analogue Input Pre-scaling

### Function

Value with which the read-in analog value ( **3320<sub>h</sub>**, **3321<sub>h</sub>** ) is divided before it is written into object **3320<sub>h</sub>**.

### Object description

Index	3322 <sub>h</sub>
Object Name	Analogue Input Pre-scaling
Object Code	ARRAY
Data type	INTEGER32
Savable	yes, category: application
Firmware Version	FIR-v1426
Change History	

### Value description

Subindex	00 <sub>h</sub>
Name	Number Of Analogue Inputs
Data type	UNSIGNED8
Access	Read only
PDO Mapping	No
Admissible Values	
Specified Value	02 <sub>h</sub>
Subindex	01 <sub>h</sub>
Name	Analogue Input 1
Data type	INTEGER32
Access	Read/write
PDO Mapping	No
Admissible Values	All values allowed, except 0
Specified Value	00000001 <sub>h</sub>
Subindex	02 <sub>h</sub>
Name	Analogue Input 2
Data type	INTEGER32
Access	Read/write
PDO Mapping	No
Admissible Values	All values allowed, except 0
Specified Value	00000001 <sub>h</sub>

### Description

- Subindex 00<sub>h</sub>: Number of dividers
- Subindex 01<sub>h</sub>: Divider for analog input 1
- Subindex 02<sub>h</sub>: Divider for analog input 2

## 3700h Following Error Option Code

### Function

The object contains the action to be executed if a "following error" is triggered.

### Object description

Index	3700 <sub>h</sub>
Object Name	Following Error Option Code
Object Code	VARIABLE
Data type	INTEGER16
Savable	yes, category: application
Access	Read/write
PDO Mapping	No
Admissible Values	
Specified Value	FFFF <sub>h</sub>
Firmware Version	FIR-v1426
Change History	

## Description

Value	Description
-32768 to -1	Reserved
0	Immediate stop with short-circuit braking
1	Braking with "slow down ramp" (deceleration depending on operating mode)
2	Braking with "quick stop ramp" (deceleration depending on operating mode)
3 to 32767	Reserved

## 4040h Drive Serial Number

### Function

This object contains the serial number of the motor controller.

### Object description

Index	4040 <sub>h</sub>
Object Name	Drive Serial Number
Object Code	VARIABLE
Data type	VISIBLE_STRING
Savable	No
Access	Read only
PDO Mapping	No
Admissible Values	
Specified Value	
Firmware Version	FIR-v1450
Change History	

## 603Fh Error Code

### Function

Contains the last error that occurred.

### Object description

Index	603F <sub>h</sub>
Object Name	Error Code
Object Code	VARIABLE
Data type	UNSIGNED16
Savable	No
Access	Read only
PDO Mapping	TX - PDO
Admissible Values	
Specified Value	0000 <sub>h</sub>
Firmware Version	FIR-v1426
Change History	

## Description

For the meaning of the error, see object **1003<sub>h</sub>** (Pre-defined Error Field).

## 6040h Controlword

### Function

The motor is switched on and travel commands can be carried out with this object.

### Object description

Index	6040 <sub>h</sub>
Object Name	Controlword
Object Code	VARIABLE
Data type	UNSIGNED16
Savable	No
Access	Read/write
PDO Mapping	RX - PDO
Admissible Values	
Specified Value	0000 <sub>h</sub>
Firmware Version	FIR-v1426
Change History	

### Description

This object controls the "**DS402 Power State machine**". The function of parts of the object are depending on the currently selected mode.

15	14	13	12	11	10	9	8	7	6	5	4	3	2	1	0
						OMS	HALT	FR		OMS [3]		EO	QS	EV	SO

#### SO (Switched On)

Value = "1": Switches to the "Switched on" state

#### EV (Enable Voltage)

Value = "1": Switches to the "Enable voltage" state

#### QS (Quick Stop)

Value = "0": Switches the "Quick stop" state

#### EO (Enable Operation)

Value = "1": Switches to the "Enable operation" state

#### OMS [3] (Operation Mode Specific)

Meaning depends on the selected operating mode

#### FR (Fault Reset)

Resets an error (if possible)

#### HALT

Value = "1": Triggers a stop

## 6041h Statusword

### Function

This object queries whether the state commanded with object **6040<sub>h</sub>** (control word) has been reached.

### Object description

Index	6041 <sub>h</sub>
Object Name	Statusword
Object Code	VARIABLE
Data type	UNSIGNED16
Savable	No
Access	Read only
PDO Mapping	TX - PDO
Admissible Values	
Specified Value	0000 <sub>h</sub>
Firmware Version	FIR-v1426
Change History	

### Description

This object controls the "**DS402 Power State machine**". The function of parts of the object are depending on the currently selected mode.

15	14	13	12	11	10	9	8	7	6	5	4	3	2	1	0
CLA		OMS [2]	ILA	TARG	REM	SYNC	WARN	SOD	QS	VE	FAULT	OE	SO	RTSO	

#### RTSO (Ready To Switch On)

Value = "1": Motor controller is in the "Ready To Switch On" state

#### SO (Switched On)

Value = "1": Motor controller is in the "Switched On" state

#### OE (Operational Enabled)

Value = "1": Motor controller is in the state "Operational Enabled" state

#### FAULT

Error occurred

#### VE (Voltage Enabled)

Voltage created

#### QS (Quick Stop)

Value = "0": Motor controller is in the "Quick Stop" state

#### SOD (Switched On Disabled)

Value = "1": Motor controller is in the "Switched on disabled" state

#### WARN (Warning)

Value = "1": Warning

#### REM (Remote)

Remote (value of bit always "1")

**TARG (Target Reached)**

Target specification reached

**ILA (Internal Limit Reached)**

Limit exceeded

**OMS (Operation Mode Specific)**

Meaning depends on the selected operating mode

**CLA (Closed Loop Available)**

Value = "1": AutoSetup successful and closed loop possible

**6042h VI Target Velocity**

**Function**

Specifies the target speed in user units.

**Object description**

---

Index	6042 <sub>h</sub>
Object Name	VI Target Velocity
Object Code	VARIABLE
Data type	INTEGER16
Savable	No
Access	Read/write
PDO Mapping	RX - PDO
Admissible Values	
Specified Value	00C8 <sub>h</sub>
Firmware Version	FIR-v1426
Change History	

---

**6043h VI Velocity Demand**

**Function**

Specifies the actual target speed in user units.

**Object description**

---

Index	6043 <sub>h</sub>
Object Name	VI Velocity Demand
Object Code	VARIABLE
Data type	INTEGER16
Savable	No
Access	Read only
PDO Mapping	TX - PDO
Admissible Values	
Specified Value	0000 <sub>h</sub>
Firmware Version	FIR-v1426
Change History	

---

## 6044h VI Velocity Actual Value

### Function

Specifies the current actual speed in user units.

In open loop mode, the source of this object can be set either to the internal, calculated value or to the encoder with object **320A<sub>h</sub>:03<sub>h</sub>**.

In closed loop mode, the source of this object can be set either to the internal, calculated value or to the encoder with object **320B<sub>h</sub>:03<sub>h</sub>**.

### Object description

Index	6044 <sub>h</sub>
Object Name	VI Velocity Actual Value
Object Code	VARIABLE
Data type	INTEGER16
Savable	No
Access	Read only
PDO Mapping	TX - PDO
Admissible Values	
Specified Value	0000 <sub>h</sub>
Firmware Version	FIR-v1426
Change History	

## 6046h VI Velocity Min Max Amount

### Function

The minimum speed and maximum speed in user units can be set with this object.

### Object description

Index	6046 <sub>h</sub>
Object Name	VI Velocity Min Max Amount
Object Code	ARRAY
Data type	UNSIGNED32
Savable	yes, category: application
Firmware Version	FIR-v1426
Change History	

### Value description

Subindex	00 <sub>h</sub>
Name	Highest Sub-index Supported
Data type	UNSIGNED8
Access	Read only
PDO Mapping	No
Admissible Values	
Specified Value	02 <sub>h</sub>
Subindex	01 <sub>h</sub>
Name	MinAmount



Data type	UNSIGNED32
Access	Read/write
PDO Mapping	RX - PDO
Admissible Values	
Specified Value	00000000 <sub>h</sub>
Subindex	02 <sub>h</sub>
Name	MaxAmount
Data type	UNSIGNED32
Access	Read/write
PDO Mapping	RX - PDO
Admissible Values	
Specified Value	00004E20 <sub>h</sub>

### Description

Subindex 1 contains the minimum speed.

Subindex 2 contains the maximum speed.

#### Note

If the magnitude of the specified target speed (object **6042<sub>h</sub>**) is less than the minimum speed, the minimum speed applies. If the target speed is 0, the motor stops.

A target speed greater than the maximum speed sets the speed to the maximum speed and sets bit 11 "Limit exceeded" in object **6041<sub>h</sub>** (status word).

## 6048h VI Velocity Acceleration

### Function

Sets the acceleration ramp in velocity mode (see " **Velocity**").

### Object description

Index	6048 <sub>h</sub>
Object Name	VI Velocity Acceleration
Object Code	RECORD
Data type	VELOCITY_ACCELERATION_DECELERATION
Savable	yes, category: application
Firmware Version	FIR-v1426
Change History	

### Value description

Subindex	00 <sub>h</sub>
Name	Highest Sub-index Supported
Data type	UNSIGNED8
Access	Read only
PDO Mapping	No
Admissible Values	
Specified Value	02 <sub>h</sub>

Subindex	01 <sub>h</sub>
Name	DeltaSpeed
Data type	UNSIGNED32
Access	Read/write
PDO Mapping	RX - PDO
Admissible Values	
Specified Value	000001F4 <sub>h</sub>
Subindex	02 <sub>h</sub>
Name	DeltaTime
Data type	UNSIGNED16
Access	Read/write
PDO Mapping	RX - PDO
Admissible Values	
Specified Value	0001 <sub>h</sub>

### Description

The acceleration is specified as a fraction:

Speed change per time change.

Subindex 01<sub>h</sub>: Contains the speed change in steps per second (U32).

Subindex 02<sub>h</sub>: Contains the time change in seconds (U16).

## 6049h VI Velocity Deceleration

### Function

Sets the brake ramp in velocity mode (siehe chapter " **Velocity** ").

### Object description

Index	6049 <sub>h</sub>
Object Name	VI Velocity Deceleration
Object Code	RECORD
Data type	VELOCITY_ACCELERATION_DECELERATION
Savable	yes, category: application
Firmware Version	FIR-v1426
Change History	

### Value description

Subindex	00 <sub>h</sub>
Name	Highest Sub-index Supported
Data type	UNSIGNED8
Access	Read only
PDO Mapping	No
Admissible Values	
Specified Value	02 <sub>h</sub>
Subindex	01 <sub>h</sub>
Name	DeltaSpeed

Data type	UNSIGNED32
Access	Read/write
PDO Mapping	RX - PDO
Admissible Values	
Specified Value	000001F4 <sub>h</sub>

Subindex	02 <sub>h</sub>
Name	DeltaTime
Data type	UNSIGNED16
Access	Read/write
PDO Mapping	RX - PDO
Admissible Values	
Specified Value	0001 <sub>h</sub>

## 604Ah VI Velocity Quick Stop

### Function

This object defines the deceleration if the quick stop state is initiated in velocity mode.

### Object description

Index	604A <sub>h</sub>
Object Name	VI Velocity Quick Stop
Object Code	RECORD
Data type	VELOCITY_ACCELERATION_DECELERATION
Savable	yes, category: application
Firmware Version	FIR-v1426
Change History	

### Value description

Subindex	00 <sub>h</sub>
Name	Highest Sub-index Supported
Data type	UNSIGNED8
Access	Read only
PDO Mapping	No
Admissible Values	
Specified Value	02 <sub>h</sub>

Subindex	01 <sub>h</sub>
Name	DeltaSpeed
Data type	UNSIGNED32
Access	Read/write
PDO Mapping	RX - PDO
Admissible Values	
Specified Value	00001388 <sub>h</sub>

Subindex	02 <sub>h</sub>
Name	DeltaTime
Data type	UNSIGNED16

Access	Read/write
PDO Mapping	RX - PDO
Admissible Values	
Specified Value	0001 <sub>h</sub>

### Description

Subindex 1 contains the speed change, and subindex 2 the associated time in seconds.

Both together are computed as the acceleration:

Velocity Quick Stop = DeltaSpeed ( **604A<sub>h</sub>:01<sub>h</sub>**)/DeltaTime ( **604A<sub>h</sub>:02<sub>h</sub>**)

## 604Ch VI Dimension Factor

### Function

The unit for the speed specifications for the objects that pertain to the Velocity Mode are defined here.

### Object description

Index	604C <sub>h</sub>
Object Name	VI Dimension Factor
Object Code	ARRAY
Data type	INTEGER32
Savable	yes, category: application
Firmware Version	FIR-v1426
Change History	

### Value description

Subindex	00 <sub>h</sub>
Name	Highest Sub-index Supported
Data type	UNSIGNED8
Access	Read only
PDO Mapping	No
Admissible Values	
Specified Value	02 <sub>h</sub>

Subindex	01 <sub>h</sub>
Name	VI Dimension Factor Numerator
Data type	INTEGER32
Access	Read/write
PDO Mapping	RX - PDO
Admissible Values	
Specified Value	00000001 <sub>h</sub>

Subindex	02 <sub>h</sub>
Name	VI Dimension Factor Denominator
Data type	INTEGER32
Access	Read/write
PDO Mapping	RX - PDO
Admissible Values	

Specified Value                      0000003C<sub>h</sub>

**Description**

If subindex 1 is set to the value "1" and subindex 2 is set to the value "60", the speed is indicated in revolutions per minute.

Otherwise, subindex 1 contains the denominator (multiplier) and subindex 2 the numerator (divisor) with which the speed specifications are computed.

The result is interpreted as revolutions per second; at object 2060<sub>h</sub>, the selection is made of whether these are electrical ( 2060<sub>h</sub> = 0) or mechanical ( 2060<sub>h</sub> = 1) revolutions per second.

**605Ah Quick Stop Option Code**

**Function**

The object contains the action to be executed when the " **DS402 Power State machine**" transitions to the Quick Stop state.

**Object description**

Index	605A <sub>h</sub>
Object Name	Quick Stop Option Code
Object Code	VARIABLE
Data type	INTEGER16
Savable	yes, category: application
Access	Read/write
PDO Mapping	No
Admissible Values	
Specified Value	0001 <sub>h</sub>
Firmware Version	FIR-v1426
Change History	

**Description**

Value	Description
-32768 to -1	Reserved
0	Immediate stop with short-circuit braking
1	Braking with "slow down ramp" (deceleration depending on operating mode) and subsequent state change to "Switch on disabled"
2	Braking with "quick stop ramp" and subsequent state change to "Switch on disabled"
3 to 32767	Reserved

**605Bh Shutdown Option Code**

**Function**

The object contains the action to be executed when the " **DS402 Power State machine**" transitions from the "Operation enabled" state to the "Ready to switch on" state.

**Object description**

Index	605B <sub>h</sub>
-------	-------------------

Object Name	Shutdown Option Code
Object Code	VARIABLE
Data type	INTEGER16
Savable	yes, category: application
Access	Read/write
PDO Mapping	No
Admissible Values	
Specified Value	0001 <sub>h</sub>
Firmware Version	FIR-v1426
Change History	

### Description

Value	Description
-32768 to -1	Reserved
0	Immediate stop with short-circuit braking
1	Braking with "slow down ramp" (deceleration depending on operating mode) and subsequent state change to "Switch on disabled"
2 to 32767	Reserved

## 605Ch Disable Option Code

### Function

The object contains the action to be executed when the "**DS402 Power State machine**" transitions from the "Operation enabled" state to the "Switched on" state.

### Object description

Index	605C <sub>h</sub>
Object Name	Disable Option Code
Object Code	VARIABLE
Data type	INTEGER16
Savable	yes, category: application
Access	Read/write
PDO Mapping	No
Admissible Values	
Specified Value	0001 <sub>h</sub>
Firmware Version	FIR-v1426
Change History	

### Description

Value	Description
-32768 to -1	Reserved
0	Immediate stop with short-circuit braking
1	Braking with "slow down ramp" (deceleration depending on operating mode) and subsequent state change to "Switch on disabled"
2 to 32767	Reserved

## 605Dh Halt Option Code

### Function

The object contains the action to be executed if stop bit 8 is set in control word **6040<sub>h</sub>**.

### Object description

Index	605D <sub>h</sub>
Object Name	Halt Option Code
Object Code	VARIABLE
Data type	INTEGER16
Savable	yes, category: application
Access	Read/write
PDO Mapping	No
Admissible Values	
Specified Value	0001 <sub>h</sub>
Firmware Version	FIR-v1426
Change History	

### Description

Value	Description
-32768 to 0	Reserved
1	Braking with "slow down ramp" (deceleration depending on operating mode)
2	Braking with "quick stop ramp" (deceleration depending on operating mode)
3 to 32767	Reserved

## 605Eh Fault Option Code

### Function

The object contains the action that is to be executed when the motor needs to be brought to idling in case of a fault.

### Object description

Index	605E <sub>h</sub>
Object Name	Fault Option Code
Object Code	VARIABLE
Data type	INTEGER16
Savable	yes, category: application
Access	Read/write
PDO Mapping	No
Admissible Values	
Specified Value	0002 <sub>h</sub>
Firmware Version	FIR-v1426
Change History	

## Description

Value	Description
-32768 to -1	Reserved
0	Immediate stop with short-circuit braking
1	Braking with "slow down ramp" (deceleration depending on operating mode)
2	Braking with "quick stop ramp" (deceleration depending on operating mode)
3 to 32767	Reserved

## 6060h Modes Of Operation

### Function

The desired operating mode is entered in this object.

### Object description

Index	6060 <sub>h</sub>
Object Name	Modes Of Operation
Object Code	VARIABLE
Data type	INTEGER8
Savable	No
Access	Read/write
PDO Mapping	RX - PDO
Admissible Values	
Specified Value	00 <sub>h</sub>
Firmware Version	FIR-v1426
Change History	

## Description

Mode	Description
-128 to -3	Manufacturer-specific operation modes
-2	Auto-Setup
-1	Clock/direction mode
0	No mode change/no mode assigned
1	Profile Position Mode
2	Velocity Mode
3	Profile Velocity Mode
4	Profile Torque Mode
5	Reserved
6	Homing Mode
7	Not assigned
8	Cyclic Synchronous Position Mode
9	Cyclic Synchronous Velocity Mode
10	Cyclic Synchronous Torque Mode
11 to 127	Reserved



## 6061h Modes Of Operation Display

### Function

Contains the current operating mode set in object **6060<sub>h</sub>** ("Modes Of Operation").

### Object description

Index	6061 <sub>h</sub>
Object Name	Modes Of Operation Display
Object Code	VARIABLE
Data type	INTEGER8
Savable	No
Access	Read only
PDO Mapping	TX - PDO
Admissible Values	
Specified Value	00 <sub>h</sub>
Firmware Version	FIR-v1426
Change History	

## 6062h Position Demand Value

### Function

Specifies the actual set position in user units.

### Object description

Index	6062 <sub>h</sub>
Object Name	Position Demand Value
Object Code	VARIABLE
Data type	INTEGER32
Savable	No
Access	Read only
PDO Mapping	TX - PDO
Admissible Values	
Specified Value	00000000 <sub>h</sub>
Firmware Version	FIR-v1426
Change History	

## 6063h Position Actual Internal Value

### Function

Contains the actual encoder position in cycles since the drive was switched on.

### Object description

Index	6063 <sub>h</sub>
Object Name	Position Actual Internal Value
Object Code	VARIABLE
Data type	INTEGER32

Savable	No
Access	Read only
PDO Mapping	TX - PDO
Admissible Values	
Specified Value	00000000 <sub>h</sub>
Firmware Version	FIR-v1426
Change History	

## 6064h Position Actual Value

### Function

Contains the current actual position (encoder position converted acc. to Feed Constant ( **6092**) and Gear Ratio ( **6091**) and reference position)

In open loop mode, the source of this object can be set either to the internal, calculated value or to the encoder with object **320A<sub>h</sub>:04<sub>h</sub>**.

In closed loop mode, the source of this object can be set either to the internal, calculated value or to the encoder with object **320B<sub>h</sub>:04<sub>h</sub>**.

### Object description

Index	6064 <sub>h</sub>
Object Name	Position Actual Value
Object Code	VARIABLE
Data type	INTEGER32
Savable	No
Access	Read only
PDO Mapping	TX - PDO
Admissible Values	
Specified Value	00000000 <sub>h</sub>
Firmware Version	FIR-v1426
Change History	

## 6065h Following Error Window

### Function

Specifies the maximum following error symmetrically to the demanded position.

### Object description

Index	6065 <sub>h</sub>
Object Name	Following Error Window
Object Code	VARIABLE
Data type	UNSIGNED32
Savable	yes, category: application
Access	Read/write
PDO Mapping	RX - PDO
Admissible Values	
Specified Value	00000100 <sub>h</sub>
Firmware Version	FIR-v1426

Change History

Firmware Version FIR-v1504: Entry "Savable" modified from "No" to "yes, category: application".

**Description**

If the value of the following error window is set to "FFFFFFFF"<sub>h</sub>, the following control is switched off.

If the difference between the actual position and the set position is so large that value of this object is exceeded, bit 11 is set for "Limit exceeded" in object **6041<sub>h</sub>** (status word). The deviation must be longer than the time in object **6066<sub>h</sub>**.

To obtain an automatic response to the error, bit 7 must be activated in object **3202<sub>h</sub>**. A fault is generated if the "following error" is created – and reacts correspondingly to it ( **6041<sub>h</sub>** bit 3 "Error occurred").

**6066h Following Error Time Out**

**Function**

Time in milliseconds until too large a following error leads to an error message.

**Object description**

Index	6066 <sub>h</sub>
Object Name	Following Error Time Out
Object Code	VARIABLE
Data type	UNSIGNED16
Savable	yes, category: application
Access	Read/write
PDO Mapping	RX - PDO
Admissible Values	
Specified Value	0064 <sub>h</sub>
Firmware Version	FIR-v1426
Change History	Firmware Version FIR-v1504: Entry "Savable" modified from "No" to "yes, category: application".

**Description**

If the difference between the actual position and the set position is so large that the value of object **6065<sub>h</sub>** is exceeded, bit 11 for "Limit exceeded" is set in **6041<sub>h</sub>** (status word). The deviation must be longer than the time in this object.

To obtain an automatic response to the error, bit 7 must be activated in object **3202<sub>h</sub>**. A fault is generated if the "following error" is created – and reacts correspondingly to it ( **6041<sub>h</sub>** bit 3 "Error occurred").

**6067h Position Window**

**Function**

Specifies a symmetrical range relative to the target position within which the target is considered to be reached.

If the value of the position window is FFFFFFFF<sub>h</sub>, the position window control shall be switched off.

### Object description

Index	6067 <sub>h</sub>
Object Name	Position Window
Object Code	VARIABLE
Data type	UNSIGNED32
Savable	yes, category: application
Access	Read/write
PDO Mapping	RX - PDO
Admissible Values	
Specified Value	0000000A <sub>h</sub>
Firmware Version	FIR-v1426
Change History	Firmware Version FIR-v1504: Entry "Savable" modified from "No" to "yes, category: application".

### 6068h Position Window Time

#### Function

For this time period in milliseconds, the actual position must be within the "Position Window" ( **6067**) for the target position to be considered to have been reached.

#### Object description

Index	6068 <sub>h</sub>
Object Name	Position Window Time
Object Code	VARIABLE
Data type	UNSIGNED16
Savable	yes, category: application
Access	Read/write
PDO Mapping	RX - PDO
Admissible Values	
Specified Value	0064 <sub>h</sub>
Firmware Version	FIR-v1426
Change History	Firmware Version FIR-v1504: Entry "Savable" modified from "No" to "yes, category: application".

### 606Bh Velocity Demand Value

#### Function

Speed specification for the control in the Profile Velocity Mode.

This object is computed with user-defined units (see also "**User-defined units**"). The motor controller is delivered with the units set to rpm.

#### Object description

Index	606B <sub>h</sub>
Object Name	Velocity Demand Value
Object Code	VARIABLE
Data type	INTEGER32

Savable	No
Access	Read only
PDO Mapping	TX - PDO
Admissible Values	
Specified Value	00000000 <sub>h</sub>
Firmware Version	FIR-v1426
Change History	

### Description

This object contains the output of the ramp generator which is the specified value for the speed controller at the same time.

## 606Ch Velocity Actual Value

### Function

The current actual speed in the profile velocity mode.

### Object description

Index	606C <sub>h</sub>
Object Name	Velocity Actual Value
Object Code	VARIABLE
Data type	INTEGER32
Savable	No
Access	Read only
PDO Mapping	TX - PDO
Admissible Values	
Specified Value	00000000 <sub>h</sub>
Firmware Version	FIR-v1426
Change History	

## 606Dh Velocity Window

### Function

Speed window for the Profile Velocity Mode.

### Object description

Index	606D <sub>h</sub>
Object Name	Velocity Window
Object Code	VARIABLE
Data type	UNSIGNED16
Savable	No
Access	Read/write
PDO Mapping	RX - PDO
Admissible Values	
Specified Value	001E <sub>h</sub>
Firmware Version	FIR-v1426
Change History	

## Description

This value specifies by how much the actual speed may vary from the set speed for bit 10 "Target reached" in status word ( **6041<sub>h</sub>**) to be set to "1".

## 606Eh Velocity Window Time

### Function

Time window for the Profile Velocity Mode.

### Object description

Index	606E <sub>h</sub>
Object Name	Velocity Window Time
Object Code	VARIABLE
Data type	UNSIGNED16
Savable	No
Access	Read/write
PDO Mapping	RX - PDO
Admissible Values	
Specified Value	0000 <sub>h</sub>
Firmware Version	FIR-v1426
Change History	

### Description

This object specifies how long the actual speed and the set speed must be near each other in magnitude (see **606D<sub>h</sub>**) for bit 10 "Target reached" in status word ( **6041<sub>h</sub>**) to be set to "1".

## 6071h Target Torque

### Function

This object contains the target torque for the "Profile Torque" and the "Cyclic Synchronous Torque" mode.

### Object description

Index	6071 <sub>h</sub>
Object Name	Target Torque
Object Code	VARIABLE
Data type	INTEGER16
Savable	No
Access	Read/write
PDO Mapping	RX - PDO
Admissible Values	
Specified Value	0000 <sub>h</sub>
Firmware Version	FIR-v1426
Change History	

## 6072h Max Torque

### Function

The object describes the maximum torque.

### Object description

Index	6072 <sub>h</sub>
Object Name	Max Torque
Object Code	VARIABLE
Data type	UNSIGNED16
Savable	yes, category: application
Access	Read/write
PDO Mapping	RX - PDO
Admissible Values	
Specified Value	0000 <sub>h</sub>
Firmware Version	FIR-v1426
Change History	

## 6074h Torque Demand

### Function

Current output value of the ramp generator (torque) for the internal control.

### Object description

Index	6074 <sub>h</sub>
Object Name	Torque Demand
Object Code	VARIABLE
Data type	INTEGER16
Savable	No
Access	Read only
PDO Mapping	TX - PDO
Admissible Values	
Specified Value	0000 <sub>h</sub>
Firmware Version	FIR-v1426
Change History	

## 607Ah Target Position

### Function

This object specifies the target position in the "Profile Position" the "Cyclic Synchronous Position" mode.

### Object description

Index	607A <sub>h</sub>
Object Name	Target Position
Object Code	VARIABLE

---

Data type	INTEGER32
Savable	No
Access	Read/write
PDO Mapping	RX - PDO
Admissible Values	
Specified Value	00000FA0 <sub>h</sub>
Firmware Version	FIR-v1426
Change History	

---

## 607Bh Position Range Limit

### Function

Contains the minimum and maximum position.

### Object description

---

Index	607B <sub>h</sub>
Object Name	Position Range Limit
Object Code	ARRAY
Data type	INTEGER32
Savable	yes, category: application
Firmware Version	FIR-v1426
Change History	

---

### Value description

---

Subindex	00 <sub>h</sub>
Name	Highest Sub-index Supported
Data type	UNSIGNED8
Access	Read only
PDO Mapping	No
Admissible Values	
Specified Value	02 <sub>h</sub>

---

Subindex	01 <sub>h</sub>
Name	Min Position Range Limit
Data type	INTEGER32
Access	Read/write
PDO Mapping	RX - PDO
Admissible Values	
Specified Value	80000001 <sub>h</sub>

---

Subindex	02 <sub>h</sub>
Name	Max Position Range Limit
Data type	INTEGER32
Access	Read/write
PDO Mapping	RX - PDO
Admissible Values	
Specified Value	7FFFFFFE <sub>h</sub>

---



## Description

If this range is exceeded or undercut, an overflow occurs. Limit values for the target position can be set in object **607D<sub>h</sub>** ("Software Position Limit") to prevent this overflow.

## 607Ch Home Offset

### Function

Specifies the difference between the zero position of the application and the reference point of the machine. This object is computed in the same unit used for calculation for object **607A<sub>h</sub>** (see "**User-defined units**").

### Object description

Index	607C <sub>h</sub>
Object Name	Home Offset
Object Code	VARIABLE
Data type	INTEGER32
Savable	yes, category: application
Access	Read/write
PDO Mapping	RX - PDO
Admissible Values	
Specified Value	00000000 <sub>h</sub>
Firmware Version	FIR-v1426
Change History	

## 607Dh Software Position Limit

### Function

Limit values for the target position.

### Object description

Index	607D <sub>h</sub>
Object Name	Software Position Limit
Object Code	ARRAY
Data type	INTEGER32
Savable	yes, category: application
Firmware Version	FIR-v1426
Change History	

### Value description

Subindex	00 <sub>h</sub>
Name	Highest Sub-index Supported
Data type	UNSIGNED8
Access	Read only
PDO Mapping	No
Admissible Values	
Specified Value	02 <sub>h</sub>

Subindex	01 <sub>h</sub>
Name	Min Position Limit
Data type	INTEGER32
Access	Read/write
PDO Mapping	RX - PDO
Admissible Values	
Specified Value	80000000 <sub>h</sub>
Subindex	02 <sub>h</sub>
Name	Max Position Limit
Data type	INTEGER32
Access	Read/write
PDO Mapping	RX - PDO
Admissible Values	
Specified Value	7FFFFFFF <sub>h</sub>

### Description

The target position must lie within the limits set here. Before the check, the home offset ( 607C<sub>h</sub>) is deducted in each case:

Corrected min position limit = min position limit - home offset

Corrected max position limit = max position limit - home offset.

## 607Eh Polarity

### Function

This object can be used to reverse the direction of rotation.

### Object description

Index	607E <sub>h</sub>
Object Name	Polarity
Object Code	VARIABLE
Data type	UNSIGNED8
Savable	yes, category: application
Access	Read/write
PDO Mapping	No
Admissible Values	
Specified Value	00 <sub>h</sub>
Firmware Version	FIR-v1426
Change History	

### Description

The general rule for direction reversal is: Reversal is activated if a bit is set to the value "1". If the value is "0", the direction of rotation is as specified in the respective mode

7	6	5	4	3	2	1	0
POS	VEL						

### VEL (Velocity)

Reversal of the direction of rotation in the following modes:

- Profile Velocity Mode
- Cyclic Synchronous Velocity Mode
- Velocity Mode

### POS (Position)

Reversal of the direction of rotation in the following modes:

- Profile Position Mode
- Cyclic Synchronous Position Mode

## 6081h Profile Velocity

### Function

Specifies the maximum traveling speed in revolutions per second.

This object is computed with user-defined units (see " **User-defined units**"). The motor controller is delivered with the units set to revolutions per minute.

### Object description

Index	6081 <sub>h</sub>
Object Name	Profile Velocity
Object Code	VARIABLE
Data type	UNSIGNED32
Savable	yes, category: application
Access	Read/write
PDO Mapping	RX - PDO
Admissible Values	
Specified Value	000001F4 <sub>h</sub>
Firmware Version	FIR-v1426
Change History	

## 6082h End Velocity

### Function

Specifies the speed at the end of the traveled ramp.

This object is computed with user-defined units (see " **User-defined units**"). The motor controller is delivered with the units set to revolutions per minute.

### Object description

Index	6082 <sub>h</sub>
Object Name	End Velocity
Object Code	VARIABLE
Data type	UNSIGNED32
Savable	yes, category: application
Access	Read/write

PDO Mapping	RX - PDO
Admissible Values	
Specified Value	00000000 <sub>h</sub>
Firmware Version	FIR-v1426
Change History	

## 6083h Profile Acceleration

### Function

Specifies the maximum acceleration in revolutions/s<sup>2</sup>.

### Object description

Index	6083 <sub>h</sub>
Object Name	Profile Acceleration
Object Code	VARIABLE
Data type	UNSIGNED32
Savable	yes, category: application
Access	Read/write
PDO Mapping	RX - PDO
Admissible Values	
Specified Value	000001F4 <sub>h</sub>
Firmware Version	FIR-v1426
Change History	

## 6084h Profile Deceleration

### Function

Specifies the maximum deceleration in revolutions/s<sup>2</sup>.

### Object description

Index	6084 <sub>h</sub>
Object Name	Profile Deceleration
Object Code	VARIABLE
Data type	UNSIGNED32
Savable	yes, category: application
Access	Read/write
PDO Mapping	RX - PDO
Admissible Values	
Specified Value	000001F4 <sub>h</sub>
Firmware Version	FIR-v1426
Change History	

## 6085h Quick Stop Deceleration

### Function

Specifies the maximum Quick Stop deceleration in revolutions/s<sup>2</sup>.

### Object description

Index	6085 <sub>h</sub>
Object Name	Quick Stop Deceleration
Object Code	VARIABLE
Data type	UNSIGNED32
Savable	yes, category: application
Access	Read/write
PDO Mapping	RX - PDO
Admissible Values	
Specified Value	00001388 <sub>h</sub>
Firmware Version	FIR-v1426
Change History	

## 6086h Motion Profile Type

### Function

Specifies the ramp type.

### Object description

Index	6086 <sub>h</sub>
Object Name	Motion Profile Type
Object Code	VARIABLE
Data type	INTEGER16
Savable	yes, category: application
Access	Read/write
PDO Mapping	RX - PDO
Admissible Values	
Specified Value	0000 <sub>h</sub>
Firmware Version	FIR-v1426
Change History	

### Description

Value = "0": = trapezoid ramp

Value = "3": Jerk-limited ramp

## 6087h Torque Slope

### Function

This object contains the torque slope in torque mode.

### Object description

Index	6087 <sub>h</sub>
Object Name	Torque Slope
Object Code	VARIABLE
Data type	UNSIGNED32
Savable	yes, category: application

Access	Read/write
PDO Mapping	RX - PDO
Admissible Values	
Specified Value	00000000 <sub>h</sub>
Firmware Version	FIR-v1426
Change History	

## 608Fh Position Encoder Resolution

### Function

Encoder cycles per revolution.

### Object description

Index	608F <sub>h</sub>
Object Name	Position Encoder Resolution
Object Code	ARRAY
Data type	UNSIGNED32
Savable	yes, category: application
Firmware Version	FIR-v1426
Change History	

### Value description

Subindex	00 <sub>h</sub>
Name	Highest Sub-index Supported
Data type	UNSIGNED8
Access	Read only
PDO Mapping	No
Admissible Values	
Specified Value	02 <sub>h</sub>

Subindex	01 <sub>h</sub>
Name	Encoder Increments
Data type	UNSIGNED32
Access	Read/write
PDO Mapping	No
Admissible Values	
Specified Value	000007D0 <sub>h</sub>

Subindex	02 <sub>h</sub>
Name	Motor Revolutions
Data type	UNSIGNED32
Access	Read/write
PDO Mapping	No
Admissible Values	
Specified Value	00000001 <sub>h</sub>

## Description

Position encoder resolution = encoder cycles (608F<sub>h</sub>:01<sub>h</sub>)/motor revolutions (608F<sub>h</sub>:02<sub>h</sub>)

## 6091h Gear Ratio

### Function

Number of motor revolutions per revolution of the output axis.

### Object description

Index	6091 <sub>h</sub>
Object Name	Gear Ratio
Object Code	ARRAY
Data type	UNSIGNED32
Savable	yes, category: application
Firmware Version	FIR-v1426
Change History	

### Value description

Subindex	00 <sub>h</sub>
Name	Highest Sub-index Supported
Data type	UNSIGNED8
Access	Read only
PDO Mapping	No
Admissible Values	
Specified Value	02 <sub>h</sub>
Subindex	01 <sub>h</sub>
Name	Motor Revolutions
Data type	UNSIGNED32
Access	Read/write
PDO Mapping	No
Admissible Values	
Specified Value	00000001 <sub>h</sub>
Subindex	02 <sub>h</sub>
Name	Shaft Revolutions
Data type	UNSIGNED32
Access	Read/write
PDO Mapping	No
Admissible Values	
Specified Value	00000001 <sub>h</sub>

### Description

Gear ratio = motor revolutions (6091<sub>h</sub>:01<sub>h</sub>) / shaft revolutions (6091<sub>h</sub>:02<sub>h</sub>)

## 6092h Feed Constant

### Function

Feed per revolution for a linear drive.

### Object description

Index	6092 <sub>h</sub>
Object Name	Feed Constant
Object Code	ARRAY
Data type	UNSIGNED32
Savable	yes, category: application
Firmware Version	FIR-v1426
Change History	

### Value description

Subindex	00 <sub>h</sub>
Name	Highest Sub-index Supported
Data type	UNSIGNED8
Access	Read only
PDO Mapping	No
Admissible Values	
Specified Value	02 <sub>h</sub>

Subindex	01 <sub>h</sub>
Name	Feed
Data type	UNSIGNED32
Access	Read/write
PDO Mapping	RX - PDO
Admissible Values	
Specified Value	00000001 <sub>h</sub>

Subindex	02 <sub>h</sub>
Name	Shaft Revolutions
Data type	UNSIGNED32
Access	Read/write
PDO Mapping	RX - PDO
Admissible Values	
Specified Value	00000001 <sub>h</sub>

### Description

Feed Constant = Feed (6092<sub>h</sub>:01<sub>h</sub>)/Shaft Revolutions (6092<sub>h</sub>:02<sub>h</sub>)

## 6098h Homing Method

### Function

This object selects the homing mode.



## Object description

Index	6098 <sub>h</sub>
Object Name	Homing Method
Object Code	VARIABLE
Data type	INTEGER8
Savable	yes, category: application
Access	Read/write
PDO Mapping	RX - PDO
Admissible Values	
Specified Value	23 <sub>h</sub>
Firmware Version	FIR-v1426
Change History	

## 6099h Homing Speed

### Function

Specifies the speeds for the Homing Mode ( **6098<sub>h</sub>** ) in revolutions/s.

This object is computed with user-defined units (see " **User-defined units** "). The motor controller is delivered with the units set to revolutions per minute.

### Object description

Index	6099 <sub>h</sub>
Object Name	Homing Speed
Object Code	ARRAY
Data type	UNSIGNED32
Savable	yes, category: application
Firmware Version	FIR-v1426
Change History	

### Value description

Subindex	00 <sub>h</sub>
Name	Highest Sub-index Supported
Data type	UNSIGNED8
Access	Read only
PDO Mapping	No
Admissible Values	
Specified Value	02 <sub>h</sub>
Subindex	01 <sub>h</sub>
Name	Speed During Search For Switch
Data type	UNSIGNED32
Access	Read/write
PDO Mapping	RX - PDO
Admissible Values	
Specified Value	00000032 <sub>h</sub>
Subindex	02 <sub>h</sub>

Name	Speed During Search For Zero
Data type	UNSIGNED32
Access	Read/write
PDO Mapping	RX - PDO
Admissible Values	
Specified Value	00000001 <sub>h</sub>

### Description

This value is computed with the numerator in object **2061<sub>h</sub>** and the denominator in object **2062<sub>h</sub>**.

The speed for the search of the switch is specified in subindex 1.

The (lower) speed for the search for the reference position is specified in Subindex 2.

#### Note

- The speed in Subindex 2 is also the starting speed for starting the acceleration ramp. If this is set too high, the motor loses steps or does not rotate at all. An excessive setting leads to the index marking being overlooked. The speed in subindex 2 should therefore be below 1000 steps per second.
- The speed in subindex 1 must be greater than the speed in subindex 2.

## 609Ah Homing Acceleration

### Function

Specifies the acceleration ramp for homing mode in steps/s<sup>2</sup>.

### Object description

Index	609A <sub>h</sub>
Object Name	Homing Acceleration
Object Code	VARIABLE
Data type	UNSIGNED32
Savable	yes, category: application
Access	Read/write
PDO Mapping	RX - PDO
Admissible Values	
Specified Value	000001F4 <sub>h</sub>
Firmware Version	FIR-v1426
Change History	

### Description

The ramp is only used when starting off. When the switch is reached, the unit is automatically switched to the lower speed and is stopped as soon as it reaches the limit position.

## 60A4h Profile Jerk

### Function

In case of a jerk-limited ramp, the magnitude of the jerk can be entered in this object. An entry with the value "0" means that the jerk is not limited.

### Object description

Index	60A4 <sub>h</sub>
Object Name	Profile Jerk
Object Code	ARRAY
Data type	UNSIGNED32
Savable	yes, category: application
Firmware Version	FIR-v1426
Change History	

### Value description

Subindex	00 <sub>h</sub>
Name	Highest Sub-index Supported
Data type	UNSIGNED8
Access	Read only
PDO Mapping	No
Admissible Values	
Specified Value	04 <sub>h</sub>

Subindex	01 <sub>h</sub>
Name	Begin Acceleration Jerk
Data type	UNSIGNED32
Access	Read/write
PDO Mapping	No
Admissible Values	
Specified Value	000003E8 <sub>h</sub>

Subindex	02 <sub>h</sub>
Name	End Acceleration Jerk
Data type	UNSIGNED32
Access	Read/write
PDO Mapping	No
Admissible Values	
Specified Value	000003E8 <sub>h</sub>

Subindex	03 <sub>h</sub>
Name	Begin Deceleration Jerk
Data type	UNSIGNED32
Access	Read/write
PDO Mapping	No
Admissible Values	
Specified Value	000003E8 <sub>h</sub>

Subindex	04 <sub>h</sub>
Name	End Deceleration Jerk
Data type	UNSIGNED32
Access	Read/write
PDO Mapping	No
Admissible Values	

Specified Value	000003E8 <sub>h</sub>
-----------------	-----------------------

## 60C2h Interpolation Time Period

### Function

This object contains the interpolation time in milliseconds squared.

### Object description

Index	60C2 <sub>h</sub>
Object Name	Interpolation Time Period
Object Code	RECORD
Data type	INTERPOLATION_TIME_PERIOD
Savable	yes, category: application
Access	Read only
PDO Mapping	No
Admissible Values	
Specified Value	
Firmware Version	FIR-v1426
Change History	

### Value description

Subindex	00 <sub>h</sub>
Name	Highest Sub-index Supported
Data type	UNSIGNED8
Access	Read only
PDO Mapping	No
Admissible Values	
Specified Value	02 <sub>h</sub>

Subindex	01 <sub>h</sub>
Name	Interpolation Time Period Value
Data type	UNSIGNED8
Access	Read/write
PDO Mapping	No
Admissible Values	
Specified Value	01 <sub>h</sub>

Subindex	02 <sub>h</sub>
Name	Interpolation Time Index
Data type	INTEGER8
Access	Read/write
PDO Mapping	No
Admissible Values	
Specified Value	FD <sub>h</sub>

### Description

The subindices have the following functions:

- 01<sub>h</sub>: Interpolation time, units: Specifies the interpolation time; at this time, only times that are powers of two are supported, such as 1, 2, 4, 8, 16, etc.
- 02<sub>h</sub>: Interpolation time, index: must hold the value of -3 (corresponds to the time basis in milliseconds).

## 60C5h Max Acceleration

### Function

This object contains the maximum admissible acceleration ramp.

For the braking ramp: see object **60C6<sub>h</sub>** "Max Deceleration".

### Object description

Index	60C5 <sub>h</sub>
Object Name	Max Acceleration
Object Code	VARIABLE
Data type	UNSIGNED32
Savable	yes, category: application
Access	Read/write
PDO Mapping	RX - PDO
Admissible Values	
Specified Value	00001388 <sub>h</sub>
Firmware Version	FIR-v1426
Change History	

## 60C6h Max Deceleration

### Function

This object contains the maximum admissible braking ramp.

For the acceleration ramp: See object **60C5<sub>h</sub>** "Max Acceleration".

### Object description

Index	60C6 <sub>h</sub>
Object Name	Max Deceleration
Object Code	VARIABLE
Data type	UNSIGNED32
Savable	yes, category: application
Access	Read/write
PDO Mapping	RX - PDO
Admissible Values	
Specified Value	00001388 <sub>h</sub>
Firmware Version	FIR-v1426
Change History	

## 60F2h Positioning Option Code

### Function

This object defines the positioning behaviour in "Profile Position" mode.

### Object description

Index	60F2 <sub>h</sub>
Object Name	Positioning Option Code
Object Code	VARIABLE
Data type	UNSIGNED16
Savable	No
Access	Read/write
PDO Mapping	RX - PDO
Admissible Values	
Specified Value	0000 <sub>h</sub>
Firmware Version	FIR-v1446
Change History	

### Description

At the moment only bit 0, 1, 6 and 7 are supported.

15	14	13	12	11	10	9	8	7	6	5	4	3	2	1	0
MS	RESERVED [3]			IP OPTION [4]				RADO [2]	RRO [2]	CIO [2]		REL. OPT. [2]			

### REL. OPT. (Relative Option)

These Bits determine relative rotation behaviour in the "Profile Position" mode when bit 6 of the controlword **6040<sub>h</sub>** = "1" is set.

Bit 1	Bit 0	Definition
0	0	Positioning moves is performed relative to the preceding (internal absolute) target position (rsp. relative to 0 if there is no preceding target position).
0	1	Positioning moves is performed relative to the actual position demand value—output of the trajectory generator.
1	0	Positioning moves is performed relative to the position actual value (object <b>6064<sub>h</sub></b> ).
1	1	Reserved

### RADO (Rotary Axis Direction Option)

These Bits determine the rotation in the "Profile Position" mode.

Bit 7	Bit 6	Definition
0	0	Normal positioning similar to linear axis; If reaching or exceeding the position range limits ( <b>607B<sub>h</sub></b> ) the input value shall wrap automatically to the other end of the range. Positioning can be relative or absolute. Only with this bit combination, the movement greater than a modulo value is possible.

Bit 7	Bit 6	Definition
0	1	Positioning only in negative direction; if target position is higher than actual position, axis moves over the min position limit <b>607D<sub>h</sub>:01<sub>h</sub></b> to the target position.
1	0	Positioning only in positive direction; if target position is lower than actual position, axis moves over the max position limit <b>607D<sub>h</sub>:02<sub>h</sub></b> to the target position.
1	1	Positioning with the shortest way to the target position.
		<p><b>Note</b></p> <p>If the difference between actual value and target position in a 360° system is 180°, the axis moves in positive direction.</p>

## 60F4h Following Error Actual Value

### Function

This object contains the current following error.

### Object description

Index	60F4 <sub>h</sub>
Object Name	Following Error Actual Value
Object Code	VARIABLE
Data type	INTEGER32
Savable	No
Access	Read only
PDO Mapping	TX - PDO
Admissible Values	
Specified Value	00000000 <sub>h</sub>
Firmware Version	FIR-v1426
Change History	

### Description

This object is computed with user-defined units (see " **User-defined units**").

## 60FDh Digital Inputs

### Function

The digital inputs of the motor can be read with this object.

### Object description

Index	60FD <sub>h</sub>
Object Name	Digital Inputs
Object Code	VARIABLE
Data type	UNSIGNED32
Savable	No
Access	Read only

PDO Mapping	TX - PDO
Admissible Values	
Specified Value	00000000 <sub>h</sub>
Firmware Version	FIR-v1426
Change History	

### Description

31	30	29	28	27	26	25	24	23	22	21	20	19	18	17	16
								IN 8	IN 7	IN 6	IN 5	IN 4	IN 3	IN 2	IN 1
15	14	13	12	11	10	9	8	7	6	5	4	3	2	1	0
													HS	PLS	NLS

#### NLS (Negative Limit Switch)

Negative limit switch

#### PLS (Positive Limit Switch)

Positive limit switch

#### HS (Home Switch)

Reference switch

#### IN n (Input n)

Input n - the number of used bits is depending on the respective motor controller.

## 60FEh Digital Outputs

### Function

The digital outputs of the motor can be written with this object.

### Object description

Index	60FE <sub>h</sub>
Object Name	Digital Outputs
Object Code	ARRAY
Data type	UNSIGNED32
Savable	No
Firmware Version	FIR-v1426
Change History	

### Value description

Subindex	00 <sub>h</sub>
Name	Highest Sub-index Supported
Data type	UNSIGNED8
Access	Read only
PDO Mapping	No
Admissible Values	
Specified Value	01 <sub>h</sub>

Subindex	01 <sub>h</sub>
Name	Digital Outputs #1



Data type	UNSIGNED32
Access	Read/write
PDO Mapping	RX - PDO
Admissible Values	
Specified Value	00000000 <sub>h</sub>

### Description

The entries in object **3250<sub>h</sub>**, subindex 02<sub>h</sub> to 05<sub>h</sub> still have to be taken into account for writing the outputs.

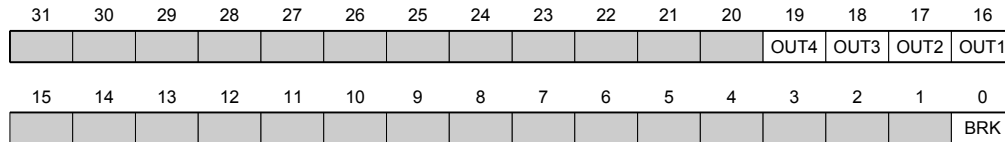

#### BRK (Brake)

Bit brake output if the controller supports this functionality.

#### OUT n (Output No n)

Bit for the respective digital output, the exact number of digital outputs is dependent on the motor controller.

## 60FFh Target Velocity

### Function

The target speed for the "Profile Velocity" the "Cyclic Synchronous Torque" mode is entered in this object.

This object is computed with user-defined units (see " **User-defined units**"). The motor controller is delivered with the units set to revolutions per minute.

### Object description

Index	60FF <sub>h</sub>
Object Name	Target Velocity
Object Code	VARIABLE
Data type	INTEGER32
Savable	No
Access	Read/write
PDO Mapping	RX - PDO
Admissible Values	
Specified Value	00000000 <sub>h</sub>
Firmware Version	FIR-v1426
Change History	

## 6502h Supported Drive Modes

### Function

The object specifies the supported drive modes.

## Object description

Index	6502 <sub>h</sub>
Object Name	Supported Drive Modes
Object Code	VARIABLE
Data type	UNSIGNED32
Savable	No
Access	Read only
PDO Mapping	TX - PDO
Admissible Values	
Specified Value	000000AF <sub>h</sub>
Firmware Version	FIR-v1426
Change History	

## Description

A set bit specifies whether the respective mode is supported. The mode is not supported if the value of the bit is "0".

31	30	29	28	27	26	25	24	23	22	21	20	19	18	17	16
15	14	13	12	11	10	9	8	7	6	5	4	3	2	1	0
						CST	CSV	CSP	IP	HM		TQ	PV	VL	PP

### PP

Profile Position mode

### VL

Velocity mode

### PV

Profile Velocity mode

### TQ

Torque mode

### HM

Homing (reference run) mode

### IP

Interpolated Position mode

### CSP

Cyclic Synchronous Position mode

### CSV

Cyclic Synchronous Velocity mode

### CST

Cyclic Sync Torque mode

## 6503h Drive Catalogue Number

### Function

This object contains the MAC address of the motor controller as a string.

### Object description

---

Index	6503 <sub>h</sub>
Object Name	Drive Catalogue Number
Object Code	VARIABLE
Data type	VISIBLE_STRING
Savable	No
Access	Read only
PDO Mapping	No
Admissible Values	
Specified Value	
Firmware Version	FIR-v1426
Change History	

---

## 6505h Http Drive Catalogue Address

### Function

This object contains the web address of the manufacturer as a string.

### Object description

---

Index	6505 <sub>h</sub>
Object Name	Http Drive Catalogue Address
Object Code	VARIABLE
Data type	VISIBLE_STRING
Savable	No
Access	Read only
PDO Mapping	No
Admissible Values	
Specified Value	<a href="http://www.nanotec.de">http://www.nanotec.de</a>
Firmware Version	FIR-v1426
Change History	

---

## 12 Copyright notice

### 12.1 Introduction

Components from external software manufacturers are integrated in the Nanotec software. In this section you will find copyright information on the external sources of software components.

### 12.2 AES

FIPS-197 compliant AES implementation

Based on XySSL: Copyright (C) 2006-2008 Christophe Devine

Copyright (C) 2009 Paul Bakker <polarssl\_maintainer at polarssl dot org>

All rights reserved.

Redistribution and use in source and binary forms, with or without modification, are permitted provided that the following conditions are met:

- Redistributions of source code must retain the above copyright notice, this list of conditions and the following disclaimer.
- Redistributions in binary form must reproduce the above copyright notice, this list of conditions and the following disclaimer in the documentation and/or other materials provided with the distribution; or, the application vendor's website must provide a copy of this notice.
- Neither the names of PolarSSL or XySSL nor the names of its contributors may be used to endorse or promote products derived from this software without specific prior written permission.

THIS SOFTWARE IS PROVIDED BY THE COPYRIGHT HOLDERS AND CONTRIBUTORS "AS IS" AND ANY EXPRESS OR IMPLIED WARRANTIES, INCLUDING, BUT NOT LIMITED TO, THE IMPLIED WARRANTIES OF MERCHANTABILITY AND FITNESS FOR A PARTICULAR PURPOSE ARE DISCLAIMED. IN NO EVENT SHALL THE COPYRIGHT OWNER OR CONTRIBUTORS BE LIABLE FOR ANY DIRECT, INDIRECT, INCIDENTAL, SPECIAL, EXEMPLARY, OR CONSEQUENTIAL DAMAGES (INCLUDING, BUT NOT LIMITED TO, PROCUREMENT OF SUBSTITUTE GOODS OR SERVICES; LOSS OF USE, DATA, OR PROFITS; OR BUSINESS INTERRUPTION) HOWEVER CAUSED AND ON ANY THEORY OF LIABILITY, WHETHER IN CONTRACT, STRICT LIABILITY, OR TORT (INCLUDING NEGLIGENCE OR OTHERWISE) ARISING IN ANY WAY OUT OF THE USE OF THIS SOFTWARE, EVEN IF ADVISED OF THE POSSIBILITY OF SUCH DAMAGE.

The AES block cipher was designed by Vincent Rijmen and Joan Daemen.

<http://csrc.nist.gov/encryption/aes/rijndael/Rijndael.pdf>

<http://csrc.nist.gov/publications/fips/fips197/fips-197.pdf>

### 12.3 Arcfour (RC4)

Copyright (c) April 29, 1997 Kalle Kaukonen.

All Rights Reserved.

Redistribution and use in source and binary forms, with or without modification, are permitted provided that this copyright notice and disclaimer are retained.

THIS SOFTWARE IS PROVIDED BY KALLE KAUKONEN AND CONTRIBUTORS ``AS IS'' AND ANY EXPRESS OR IMPLIED WARRANTIES, INCLUDING, BUT NOT LIMITED TO, THE IMPLIED WARRANTIES OF MERCHANTABILITY AND FITNESS FOR A PARTICULAR PURPOSE ARE DISCLAIMED. IN NO EVENT SHALL KALLE KAUKONEN OR CONTRIBUTORS BE LIABLE FOR ANY DIRECT, INDIRECT, INCIDENTAL, SPECIAL, EXEMPLARY, OR CONSEQUENTIAL DAMAGES (INCLUDING, BUT NOT LIMITED TO, PROCUREMENT OF SUBSTITUTE GOODS OR SERVICES; LOSS OF USE, DATA, OR PROFITS; OR BUSINESS INTERRUPTION) HOWEVER CAUSED

AND ON ANY THEORY OF LIABILITY, WHETHER IN CONTRACT, STRICT LIABILITY, OR TORT (INCLUDING NEGLIGENCE OR OTHERWISE) ARISING IN ANY WAY OUT OF THE USE OF THIS SOFTWARE, EVEN IF ADVISED OF THE POSSIBILITY OF SUCH DAMAGE.

## 12.4 MD5

MD5C.C - RSA Data Security, Inc., MD5 message-digest algorithm

Copyright (C) 1991-2, RSA Data Security, Inc. Created 1991. All rights reserved.

License to copy and use this software is granted provided that it is identified as the "RSA Data Security, Inc. MD5 Message-Digest Algorithm" in all material mentioning or referencing this software or this function.

License is also granted to make and use derivative works provided that such works are identified as "derived from the RSA Data Security, Inc. MD5 Message-Digest Algorithm" in all material mentioning or referencing the derived work.

RSA Data Security, Inc. makes no representations concerning either the merchantability of this software or the suitability of this software for any particular purpose. It is provided "as is" without express or implied warranty of any kind.

These notices must be retained in any copies of any part of this documentation and/or software.

## 12.5 uIP

Copyright (c) 2005, Swedish Institute of Computer Science

All rights reserved.

Redistribution and use in source and binary forms, with or without modification, are permitted provided that the following conditions are met:

1. Redistributions of source code must retain the above copyright notice, this list of conditions and the following disclaimer.
2. Redistributions in binary form must reproduce the above copyright notice, this list of conditions and the following disclaimer in the documentation and/or other materials provided with the distribution.
3. Neither the name of the Institute nor the names of its contributors may be used to endorse or promote products derived from this software without specific prior written permission.

THIS SOFTWARE IS PROVIDED BY THE INSTITUTE AND CONTRIBUTORS ``AS IS" AND ANY EXPRESS OR IMPLIED WARRANTIES, INCLUDING, BUT NOT LIMITED TO, THE IMPLIED WARRANTIES OF MERCHANTABILITY AND FITNESS FOR A PARTICULAR PURPOSE ARE DISCLAIMED. IN NO EVENT SHALL THE INSTITUTE OR CONTRIBUTORS BE LIABLE FOR ANY DIRECT, INDIRECT, INCIDENTAL, SPECIAL, EXEMPLARY, OR CONSEQUENTIAL DAMAGES (INCLUDING, BUT NOT LIMITED TO, PROCUREMENT OF SUBSTITUTE GOODS OR SERVICES; LOSS OF USE, DATA, OR PROFITS; OR BUSINESS INTERRUPTION) HOWEVER CAUSED AND ON ANY THEORY OF LIABILITY, WHETHER IN CONTRACT, STRICT LIABILITY, OR TORT (INCLUDING NEGLIGENCE OR OTHERWISE) ARISING IN ANY WAY OUT OF THE USE OF THIS SOFTWARE, EVEN IF ADVISED OF THE POSSIBILITY OF SUCH DAMAGE.

## 12.6 DHCP

Copyright (c) 2005, Swedish Institute of Computer Science

All rights reserved.

Redistribution and use in source and binary forms, with or without modification, are permitted provided that the following conditions are met:

1. Redistributions of source code must retain the above copyright notice, this list of conditions and the following disclaimer.

2. Redistributions in binary form must reproduce the above copyright notice, this list of conditions and the following disclaimer in the documentation and/or other materials provided with the distribution.
3. Neither the name of the Institute nor the names of its contributors may be used to endorse or promote products derived from this software without specific prior written permission.

THIS SOFTWARE IS PROVIDED BY THE INSTITUTE AND CONTRIBUTORS ``AS IS" AND ANY EXPRESS OR IMPLIED WARRANTIES, INCLUDING, BUT NOT LIMITED TO, THE IMPLIED WARRANTIES OF MERCHANTABILITY AND FITNESS FOR A PARTICULAR PURPOSE ARE DISCLAIMED. IN NO EVENT SHALL THE INSTITUTE OR CONTRIBUTORS BE LIABLE FOR ANY DIRECT, INDIRECT, INCIDENTAL, SPECIAL, EXEMPLARY, OR CONSEQUENTIAL DAMAGES (INCLUDING, BUT NOT LIMITED TO, PROCUREMENT OF SUBSTITUTE GOODS OR SERVICES; LOSS OF USE, DATA, OR PROFITS; OR BUSINESS INTERRUPTION) HOWEVER CAUSED AND ON ANY THEORY OF LIABILITY, WHETHER IN CONTRACT, STRICT LIABILITY, OR TORT (INCLUDING NEGLIGENCE OR OTHERWISE) ARISING IN ANY WAY OUT OF THE USE OF THIS SOFTWARE, EVEN IF ADVISED OF THE POSSIBILITY OF SUCH DAMAGE.

## 12.7 CMSIS DSP Software Library

Copyright (C) 2010 ARM Limited. All rights reserved.

## 12.8 FatFs

FatFs - FAT file system module include file R0.08 (C)ChaN, 2010

FatFs module is a generic FAT file system module for small embedded systems.

This is a free software that opened for education, research and commercial developments under license policy of following terms.

Copyright (C) 2010, ChaN, all right reserved.

The FatFs module is a free software and there is NO WARRANTY.

No restriction on use. You can use, modify and redistribute it for personal, non-profit or commercial product UNDER YOUR RESPONSIBILITY.

Redistributions of source code must retain the above copyright notice.

## 12.9 Protothreads

Protothread class and macros for lightweight, stackless threads in C++.

This was "ported" to C++ from Adam Dunkels' protothreads C library at: <http://www.sics.se/~adam/pt/>

Originally ported for use by Hamilton Jet ([www.hamiltonjet.co.nz](http://www.hamiltonjet.co.nz)) by Ben Hoyt, but stripped down for public release. See his blog entry about it for more information: <http://blog.micropledge.com/2008/07/protothreads/>

Original BSD-style license

Copyright (c) 2004-2005, Swedish Institute of Computer Science.

All rights reserved.

Redistribution and use in source and binary forms, with or without modification, are permitted provided that the following conditions are met:

1. Redistributions of source code must retain the above copyright notice, this list of conditions and the following disclaimer.
2. Redistributions in binary form must reproduce the above copyright notice, this list of conditions and the following disclaimer in the documentation and/or other materials provided with the distribution.
3. Neither the name of the Institute nor the names of its contributors may be used to endorse or promote products derived from this software without specific prior written permission.

This software is provided by the Institute and contributors "as is" and any express or implied warranties, including, but not limited to, the implied warranties of merchantability and fitness for a particular purpose are disclaimed. In no event shall the Institute or contributors be liable for any direct, indirect, incidental, special, exemplary, or consequential damages (including, but not limited to, procurement of substitute goods or services; loss of use, data, or profits; or business interruption) however caused and on any theory of liability, whether in contract, strict liability, or tort (including negligence or otherwise) arising in any way out of the use of this software, even if advised of the possibility of such damage.

## 12.10 Lightweight IP

Copyright (c) 2001-2004 Swedish Institute of Computer Science.

All rights reserved.

Redistribution and use in source and binary forms, with or without modification, are permitted provided that the following conditions are met:

1. Redistributions of source code must retain the above copyright notice, this list of conditions and the following disclaimer.
2. Redistributions in binary form must reproduce the above copyright notice, this list of conditions and the following disclaimer in the documentation and/or other materials provided with the distribution.
3. The name of the author may not be used to endorse or promote products derived from this software without specific prior written permission.

THIS SOFTWARE IS PROVIDED BY THE AUTHOR ``AS IS" AND ANY EXPRESS OR IMPLIED WARRANTIES, INCLUDING, BUT NOT LIMITED TO, THE IMPLIED WARRANTIES OF MERCHANTABILITY AND FITNESS FOR A PARTICULAR PURPOSE ARE DISCLAIMED. IN NO EVENT SHALL THE AUTHOR BE LIABLE FOR ANY DIRECT, INDIRECT, INCIDENTAL, SPECIAL, EXEMPLARY, OR CONSEQUENTIAL DAMAGES (INCLUDING, BUT NOT LIMITED TO, PROCUREMENT OF SUBSTITUTE GOODS OR SERVICES; LOSS OF USE, DATA, OR PROFITS; OR BUSINESS INTERRUPTION) HOWEVER CAUSED AND ON ANY THEORY OF LIABILITY, WHETHER IN CONTRACT, STRICT LIABILITY, OR TORT (INCLUDING NEGLIGENCE OR OTHERWISE) ARISING IN ANY WAY OUT OF THE USE OF THIS SOFTWARE, EVEN IF ADVISED OF THE POSSIBILITY OF SUCH DAMAGE.

This file is part of the lwIP TCP/IP stack.

Author: Adam Dunkels <adam@sics.se>