

Technical Manual

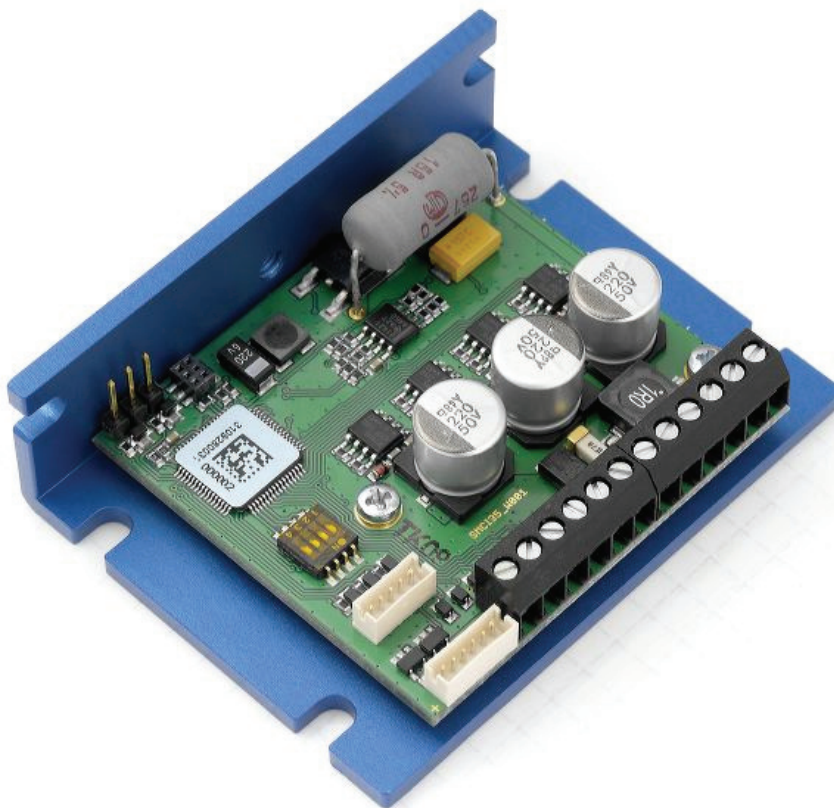

Controller for stepper and BLDC motors **SMC135**

NANOTEC ELECTRONIC GmbH & Co. KG
Kapellenstraße 6
D-85622 Feldkirchen b. Munich, Germany

Tel. +49 (0)89-900 686-0
Fax +49 (0)89-900 686-50
info@nanotec.com

Editorial

© 2011

Nanotec[®] Electronic GmbH & Co. KG
Kapellenstraße 6
D-85622 Feldkirchen b. Munich, Germany

Tel.: +49 (0)89-900 686-0
Fax: +49 (0)89-900 686-50

Internet: www.nanotec.com

All rights reserved!

MS-Windows 2000/XP/Vista are registered trademarks of Microsoft Corporation.

Translation of the original operation manual

Version/Change overview

Version	Date	Changes
1.0	01/25/2010	New issue C+P
1.1	03/05/2010	New picture on cover page
1.2	03/22/2010	Various changes
1.3	11/03/2010	BLDC use
1.4	11/03/2011	Revision C+P

About this manual

Target group

This technical manual is aimed at designers and developers who need to operate a Nanotec[®] motor without much experience in stepper motor technology.

Important information

This technical manual must be carefully read before installation and commissioning of the controller.



Nanotec[®] reserves the right to make technical alterations and further develop hardware and software in the interests of its customers to improve the function of this product without prior notice.

This manual was created with due care. It is exclusively intended as a technical description of the product and as commissioning instructions. The warranty is exclusively for repair or replacement of defective equipment, according to our general terms and conditions; liability for subsequent damage or errors is excluded. Applicable standards and regulations must be complied with during installation of the device.

For criticisms, proposals and suggestions for improvement, please contact the above address or send an email to: info@nanotec.com

Additional manuals

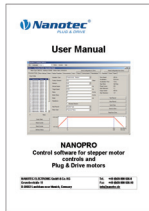
Please also note the following manuals from Nanotec:

<p>NanoPro User Manual</p>	<p>Configuration of controllers with the NanoPro software</p>	
<p>Programming manual</p>	<p>Controller programming</p> <ul style="list-style-type: none"> • Command reference • NanoJ • COM interface 	

The manuals are available for download at www.nanotec.com.

Contents

1	Overview	5
2	Connection and commissioning	7
2.1	Overview	7
2.2	Stepper motor	8
2.3	BLDC motor	9
2.4	Commissioning.....	10
3	Connections and circuits	12
3.1	Inputs and outputs: Connector X4 and X5.....	12
3.2	Encoder connection: Connector X2	14
3.3	Motor and voltage supply connection: Connector X3	16
3.3.1	Pin assignment.....	16
3.3.2	Stepper motor connection	16
3.3.3	BLDC motor connection.....	16
3.3.4	Power supply connection	17
3.4	Setting the motor current	18
3.5	RS232 interface: Connector X1	19
4	Operating modes.....	20
5	Troubleshooting.....	22
6	Technical data	23
	Index.....	27

1 Overview

Introduction

Motor control SMCI35 is an extremely compact and cost-effective constant current power output stage with integrated Closed-Loop current control.

Due to the great capacity and functions available, it offers designers and developers a rapid and simple method of resolving numerous drive requirements with less programming effort.

It is used for controlling standard stepper motors (including with attached encoders) or motors with an integrated encoder. BLDC motors are also supported.

The SMCI35 is ideal for device installation due to its open, economical design and TTL signal level (5 V). For machine integration, we recommend the closed controllers SMCI33 and SMCI47-S-2, which can also process 24 V signals and are built on the same software basis.

SMCI35 functions

The SMCI35 controller contains the following functions:

- 12-48 V supply voltage, max. 6 A eff. phase current
- Microstep -1/1 – 1/64 final output stage (step resolution of up to 0.014° in motors with a step angle of 0.9° in 1/64 step mode)
- Closed-Loop current control (sinusoidal commutation via the encoder)
- Sinus commutation for BLDC motors with hall sensors for better running smoothness and higher speed ranges
- Microstep emulation in full step operation for smoother running
- Powerful DSP microprocessor for flexible I/O
- Sequence programs with NanoJ
- Easy programming with the NanoPro Windows software



Closed-Loop current control (sinusoidal commutation via the encoder):

In contrast to conventional controllers where only the motor is actuated or the position adjusted via the encoder, sinusoidal commutation controls the stator magnetic field via the rotary encoder as in a servomotor. The stepper motor acts in this operating mode as nothing more than a high pole servomotor, i.e. the classic stepper motor noises and resonances vanish. As the current is controlled, the motor can no longer lose any steps up to its maximum torque.

If the controller recognizes that the rotor is falling behind the stator field due to overload, adjustments are made with optimal field angle and increased current. In the opposite case, i.e. if the rotor is running forward due to the torque, the current is automatically reduced so that current consumption and heat development in the motor and controller are much lower compared to normal controlled operation.

dspDrive[®]

With dspDrive[®], the motor current is controlled directly by a digital signal processor. Unlike conventional ICs, which resolve the winding current measurement and the target current value with only 6 or 8 bit, the new dspDrive[®] performs the entire control with a resolution of 12 bit. The parameters of the PI current controller can be adjusted to the motor and by the user as a function of the rpm.

This has the following application advantages:

- Very smooth, low-resonance operation with a sinusoidal current in the windings, even at low speeds.
- Very good step angle accuracy and synchronization, even in open-loop operation.
- BLDC motors can be controlled as well.

NanoJ

The integrated programming language NanoJ, based on the Java standard, means complete application programs can be realized on the drivers that can be executed independently without a higher-order controller.

The programs can be created, compiled directly and written to the controller with the free NanoJEasy editor.

More detailed information can be found in the separate programming manual.

Presettings

When the SMCI35 is delivered, it is preconfigured to clock direction mode. Connection to the PC is not necessary. The phase current can be set in 10% steps on a DIP switch (10% = 400 mA, max. 150% = 6 A).

The inputs for the clock, direction and enable signal are already preconfigured on the X4 connector.

The step mode can only be changed via software. Full step is preset. Microstep emulation, however, means extremely smooth running and very good performance of the stepper motor is already achieved in the full step.

Further settings

The operating behavior of the motor can be set and optimized according to individual requirements by setting the motor-related parameters. The parameters can be set using the NanoPro software and significantly reduce commissioning time.

An RS232 (3.3 V) to USB converter is required for this (Nanotec item number: ZK-RS232-USB-3.3V).

More detailed information on this can be found in the separate NanoPro user manual.

2 Connection and commissioning

2.1 Overview

Plug connections

The controller has the following connectors:

X1: RS232 interface (3.3 V)

X2: Encoder interface

X3: Motor and power supply connection

X4 and X5: Inputs and outputs

Configuration

The following figure shows the configuration of the connectors on the printed circuit board.

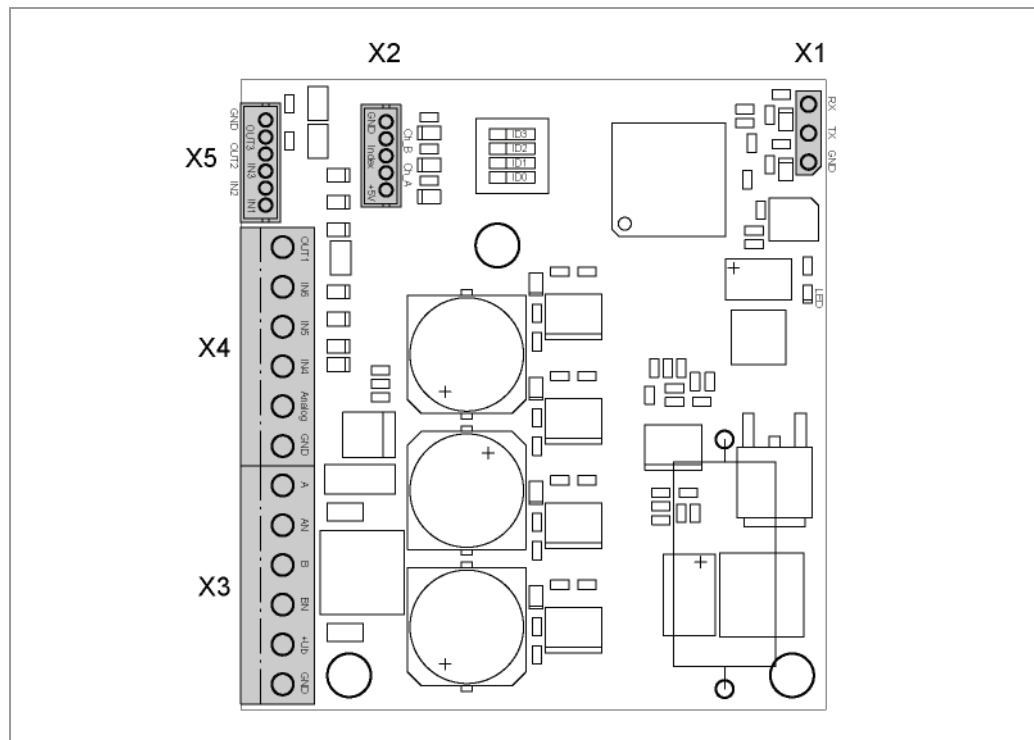

2.2 Stepper motor

Connection diagram

To operate a stepper motor with the SMC135, the wiring must be implemented according to the following connection diagram.

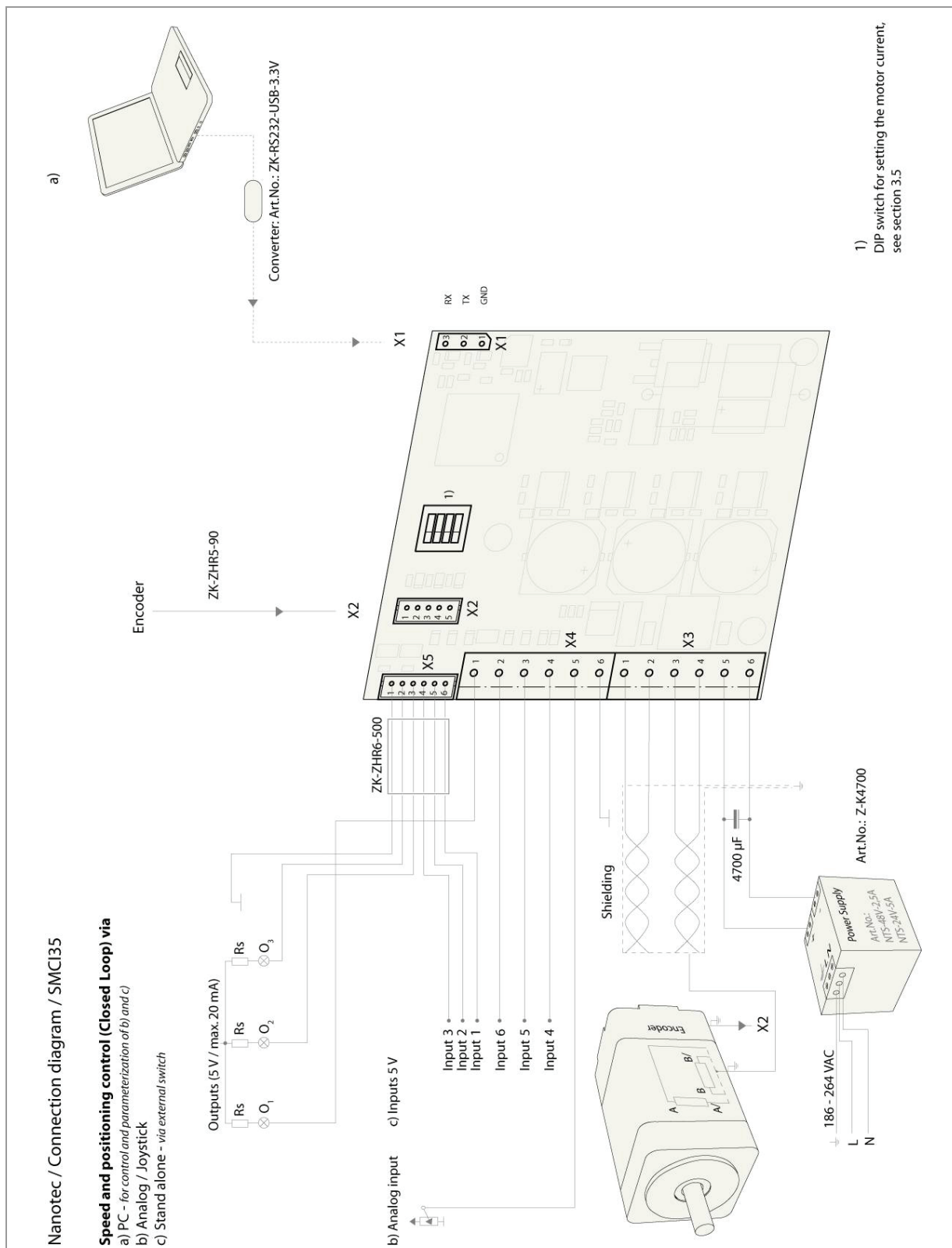

The pin configuration for the motor can be found on the motor data sheet, which can be downloaded from www.nanotec.com.

2.3 BLDC motor

Connection diagram

In order to operate a BLDC motor using the SMCI35, you must carry out the wiring in accordance with the connection diagram below.

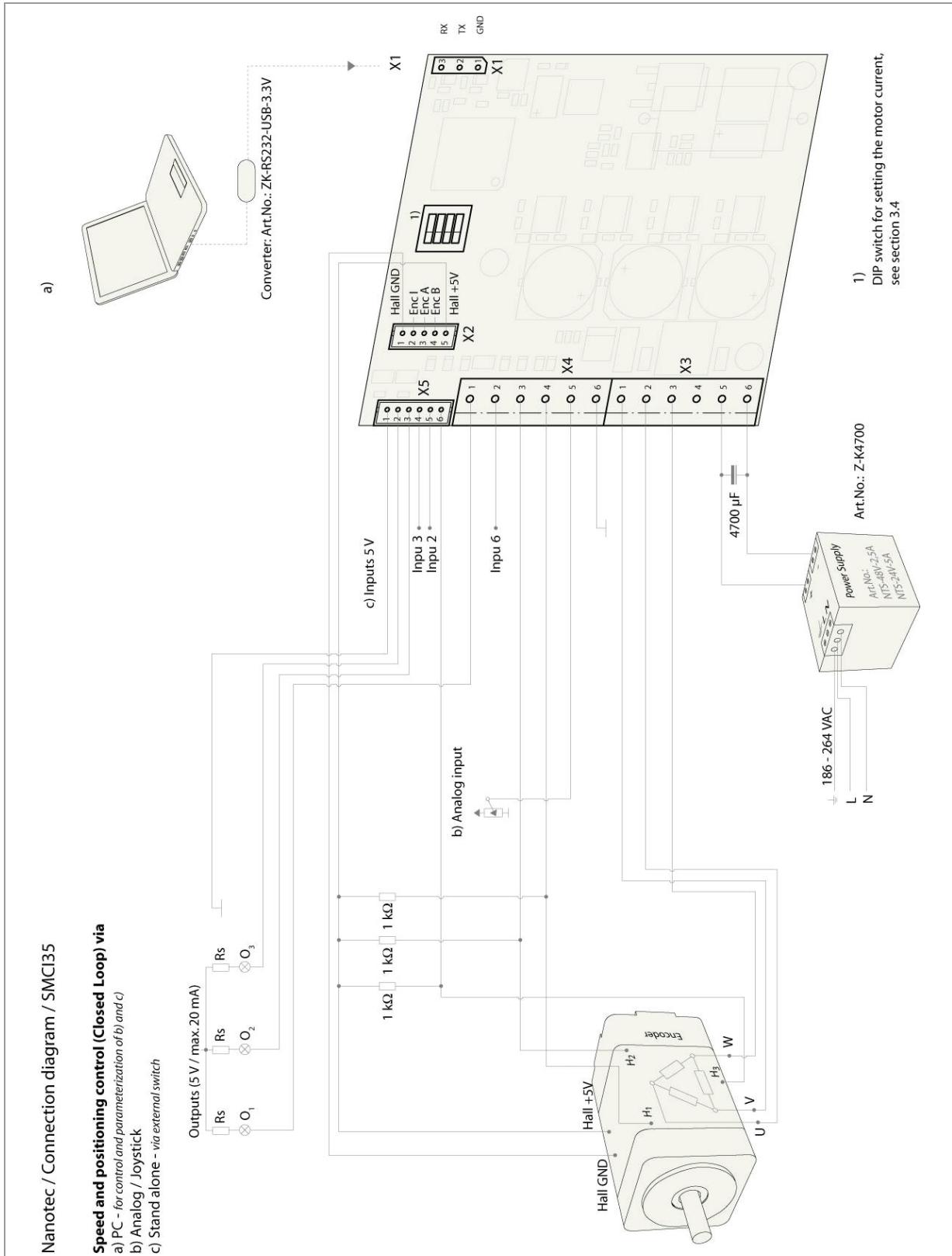

The pin configuration for the motor can be found on the motor data sheet, which can be downloaded from www.nanotec.com.

2.4 Commissioning

Operation with presets

The SMCI35 is delivered with the following presets:

- Operating mode: Clock direction
- Stepper mode: Full step (with microstep emulation)
- Inputs on X4 connector (all 5 V):
 - Input 6 = clock signal
 - Input 5 = direction signal
 - Input 4 = enable (low or open = disable)
- Current level: 10%

The phase current is set on a DIP switch, see Section “3.4 Setting the motor current”.

For a controller in its delivered state, if you now apply clock signals to input 6, the connected motor will turn by one step with each clock signal (e.g. 1.8° mechanically for a standard stepper motor).

Configuration with NanoPro

The following steps are only necessary if the controller is not to be operated in the preset clock direction mode or if a BLDC motor is to be connected.

This section describes the main first steps you need to take to be able to quickly begin working with the SMCI35 if you are using the NanoPro software from a PC. You will find more detailed information in the separate NanoPro manual.

If you want to work with a PLC or your own program later, you will find the necessary information in the separate programming manual.

Familiarize yourself with the SMCI35 controller and the corresponding NanoPro control software before you configure the controller for your application.

Proceed as follows:

Step	Action	Note
1	Install the NanoPro control software on your PC. See the NanoPro separate manual.	Download of www.nanotec.com
2	Connect the controller to the stepper motor according to the connection diagram.	Connection diagram, see Section 2. Detailed information on connections can be found in Section 3.
3	Switch on the operating voltage (12 V DC ... 48 V DC).	The red LED lights up briefly.
4	If necessary, install the converter driver for the converter cable ZK-RS232-USB-3.3V.	Download www.nanotec.com in the Accessories/Converter menu item
5	Connect the controller to the USB port of your PC. Use the converter cable ZK-RS232-USB-3.3V.	Order identifier: <ul style="list-style-type: none">• ZK-RS232-USB-3.3V

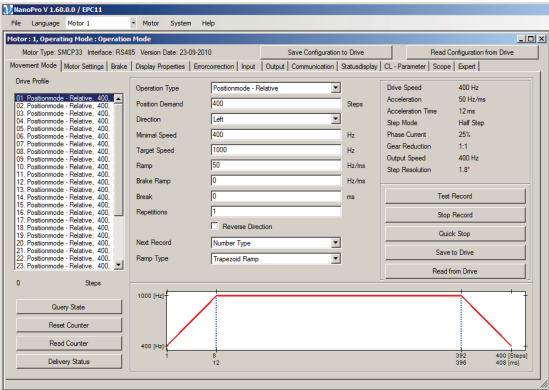
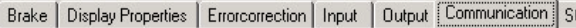
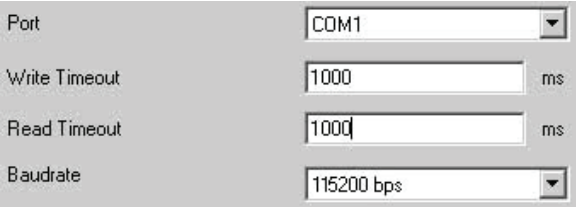
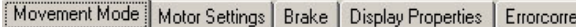
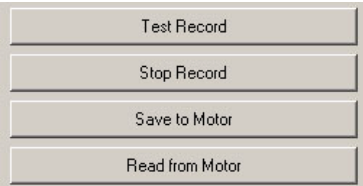
Step	Action	Note
6	<p>Start the NanoPro software.</p> 	The NanoPro main menu appears.
7	<p>Select the <Communication> tab.</p> 	
8	<p>In the "Port" field, select the COM port to which the SMCI35 is connected.</p> 	The number of the COM port to which the controller is connected can be found in the device manager of your Windows PC (System Control/System/Hardware).
9	<p>Select the "115200 bps" entry in the "Baudrate" selection field.</p>	
10	<p>Check the current setting using the motor data sheet.</p>	Under no circumstances may the current be set to a value higher than the rated current of the motor.
11	<p>Select the "Movement Mode" tab.</p> 	
12	<p>Click on the <Test Record> button to carry out the pre-set travel profile.</p> 	The connected motor operates with the pre-set travel profile (default travel profile after new installation).
13	<p>You can now enter your required settings. For instance, you can enter a new travel profile.</p>	See the NanoPro separate manual.

3 Connections and circuits

3.1 Inputs and outputs: Connector X4 and X5

Introduction

An overview of the assignments can be found in the connection diagram in Section 2. This section looks in detail at the assignments, functions and circuits of connectors X4 and X5.

Pin assignment X4

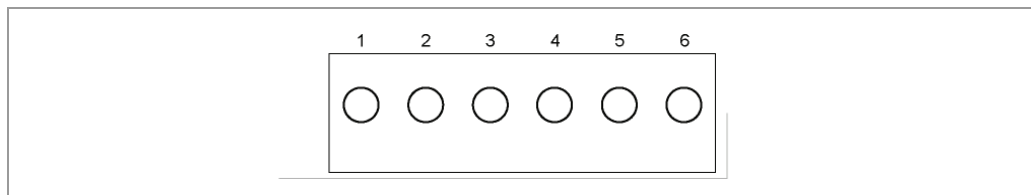

Pin no.	Name	Observations
1	Output 1	Digital output (max. +5 V)
2	Input 6	Digital inputs (max. 5 V); For BLDC motors: <ul style="list-style-type: none"> Input 5 = Hall sensor H2 Input 4 = Hall sensor H1
3	Input 5	
4	Input 4	
5	Analogue In 1	Analog input (−10 V ... +10 V)
6	GND	

Pin assignment X5

The X5 connector is a JST-ZHR6 connector.
Matching connection cable: ZK-ZHR6-500 (length 500 mm, single-conductor).

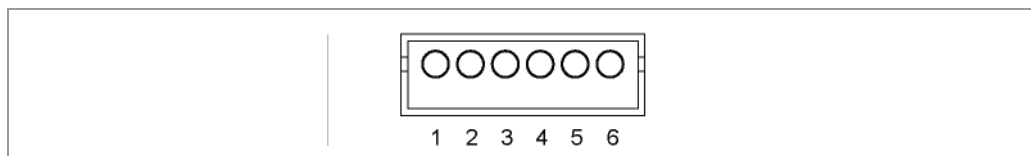

Pin no.	Name	Observations
1	GND	
2	Output 3	Digital outputs (max. +5 V)
3	Output 2	
4	Input 3	Digital inputs; For BLDC motors: <ul style="list-style-type: none"> Input 1 = Hall sensor H3
5	Input 2	
6	Input 1	

Function of the inputs

All digital inputs – with the exception of the "Clock" input in the clock directional mode – can be freely programmed using the NanoPro software (e.g. as a limit position switch, enable, etc.) and can be used for sequential control with NanoJ.

All inputs can be configured for “active-high” (PNP) or “active-low” (NPN) with NanoPro.

Signal states at the outputs

The following table shows the possible signal states at the outputs 1 to 3:

Signal states			Meaning
Output 3	Output 2	Output 1	
	0	0	Rotation monitoring (error) or limit switch
	0	1	Motor idle (waiting for new command)
	1	0	Busy (control processing last command)
	1	1	Reference point or zero point reached
1			Overtemperature

The outputs can be freely programmed using the NanoPro software.

Note:

Output 3 is also used to display errors and when switching on the controller.

Input circuits

Note:

The voltage must not exceed 5 V. It should drop below 2 V for safe switching off and be at least 4.5 V for safe switching on.

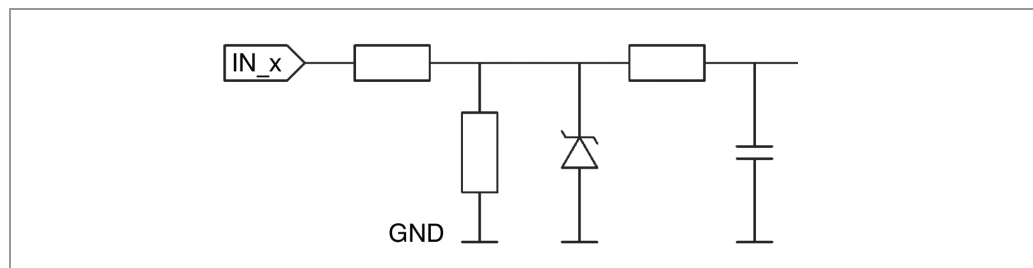

Circuitry of hall sensors in BLDC mode

See Section 2.3 “BLDC motor”.

Output circuits

The outputs are a TTL output circuit (5 V / max. 20 mA). To be able to test the output, an LED with a series resistance against earth can be integrated. The LED lights up when the output is active.

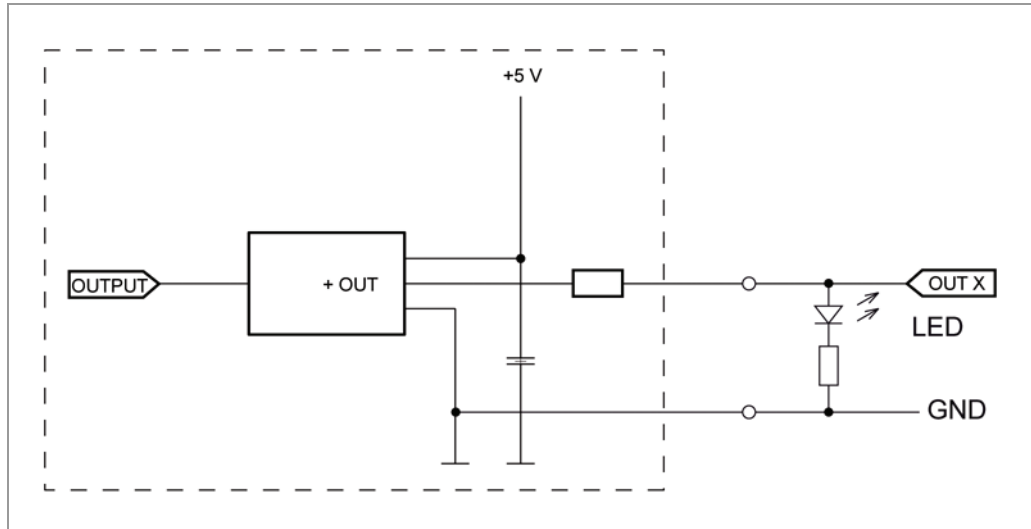

3.2 Encoder connection: Connector X2

Pin assignment

The X2 connector is a JST-ZHR5 connector.
Matching connection cable: ZK-ZHR5-90 (length 90 mm, single-conductor).

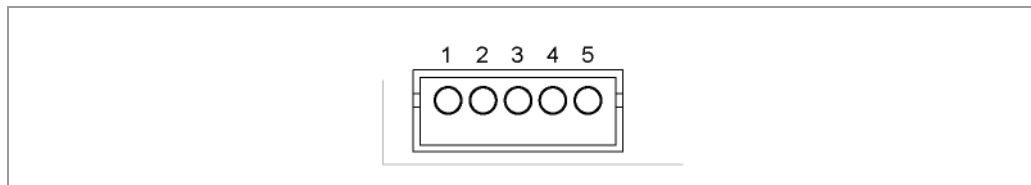

Pin no.	Name	Observations
1	GND	With BLDC motors, pin 1 (GND) and pin 5 (+5 V) are used for supplying the hall sensors, see Section 2.3 "BLDC motor".
2	Track (B)	
3	Index track (I)	
4	Track (A)	
5	+5 V	

Optional encoder

An optional encoder can be connected to the controller.

By default, the closed-loop control for a three-channel encoder is set up with 500 pulses/revolution in a 1.8° stepper motor. With an 0.9° stepper motor, you should use an encoder with 1000 pulses/revolution to achieve the same control quality. Depending on the application, it may make sense to use higher encoder resolutions (up to max. 2000 pulses/revolution) to improve control quality or to use a lower resolution (min. 200 pulses/revolution) for low-cost applications or for step monitoring alone.

The following encoder resolutions can normally be processed by the controller: 192, 200, 400, 500, 512, 1000, 1024, 2000, 2048.

Recommended

Where possible, use Nanotec encoders with the order number WEDS/WEDL-5541 Xxx.

If an encoder is **not** used, the "Disable" mode must be set in the <Error correction> tab in the "Rotation Direction Mode" selection menu. See the NanoPro separate manual.

Using encoders with line drivers

The encoders of the WEDL series with a line driver output an inverted signal in addition to the encoder signal; this leads to better interference immunity and is especially recommended for long lines lengths (> 500 mm) and neighboring interference sources. The differential signal can be evaluated with a line driver/encoder adapter.

Since the SMCI35 is designed for device installation, the differential signals are not evaluated so that only channels A, B and I need to be connected to perform position monitoring. We recommend shielding and twisting the encoder line to minimize interference with the encoder signal from the outside.

If the line length in your application exceeds 500 mm, or if there is interference on the lines due to other sources, we recommend the use of controller SMCI33 or SMCI47-S, for which there is an adapter for encoders with a line driver.

3.3 Motor and voltage supply connection: Connector X3

3.3.1 Pin assignment

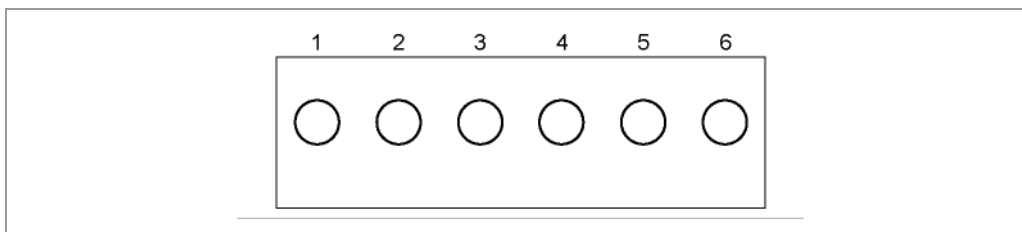

Pin no.	Name	Observations
1	A	See the data sheet of the connected stepper motor.
2	A/	For BLDC motors: <ul style="list-style-type: none"> • A = V • A/ = U • B = W • B/ = not connected
3	B	
4	B/	
5	Vcc	
6	GND	Earth (0 V)

3.3.2 Stepper motor connection

General information

The motor is connected to the SMCI35 with a 4-wire cable. Twisted wire pair cables with braided shields are recommended.



Danger of electrical surges

Mixing up the connections can destroy the output stage! See the data sheet of the connected stepper motor.

Never disconnect the motor when operating voltage is applied!

Never disconnect lines when live!

3.3.3 BLDC motor connection

See Section 2.3 "BLDC motor".

3.3.4 Power supply connection

Permissible operating voltage

The permissible operating voltage for the SMC135 lies between +12 and +48 V DC; it must not exceed 50 V or fall below 10 V.

A charging condenser with minimum 4700 μF (10000 μF) must be provided for the operating voltage to prevent exceeding the permissible operating voltage (e.g. during braking).

	<p>Danger of electrical surges</p> <p>Connect charging condenser with minimum 4700 μF!</p> <p>Connect a condenser with 10000 μF for motors with flange size 86x86 (series ST8918) or greater!</p> <p>An operating voltage > 50 V will destroy the output stage!</p> <p>Mixing up the connections can destroy the output stage! See the data sheet of the connected stepper motor.</p> <p>Never disconnect the motor when operating voltage is applied!</p> <p>Never disconnect lines when live!</p>
---	--

Connection diagram

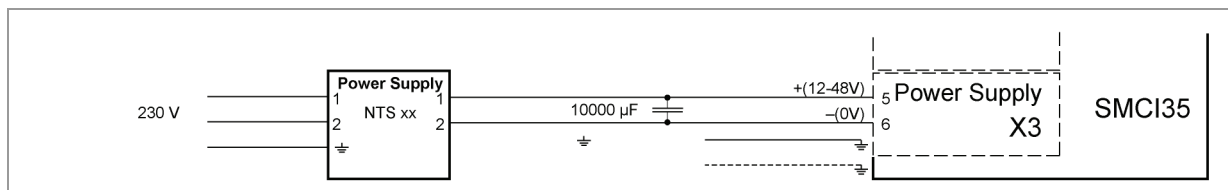

Note:
Complete connection diagram, see Section 2 "Connection and commissioning".

Accessories

Appropriate power packs and charging condensers are available as accessories:

Name	Order identifier
Power pack	NTS-xxV-yA (xx=voltage: 12, 24 or 48 V, y=current: 2.5, 5 or 10 A) Information on the selection of the required power supply unit can be found in our FAQ on www.nanotec.com .
Charging condenser	Z-K4700 or Z-K10000

Note:
Further information about accessories can be found on the Nanotec website www.nanotec.com.

3.4 Setting the motor current

Setting options

The motor current can be set either in the software (NanoPro) or in the hardware via the DIP switch on the board.

DIP switch

The DIP switches form the first four digits of the binary system, where the digit with the lowest value is set with switch "0" and the digit with the highest value is set with switch "3". In this way, the decimal values of 0 to 15 can be set.

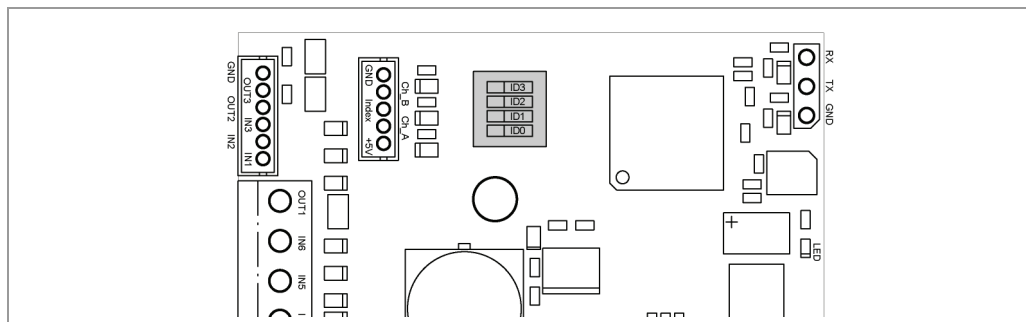

Procedure

If all DIP switches are set to OFF (decimal value 0), the motor current can be specified via NanoPro. For all other DIP switch settings, the motor current results from the following equation (in % of effective current 4 A):

$$\text{Motor current} = \text{dip switch decimal value} * 10\%$$

Example: switch 3 = ON, switch 2 = OFF, switch 1 = OFF, switch 0 = ON

→ Decimal value = 9

→ Motor current = 90% of effective current = 3.6 A

DIP switch				Phase current	
3	2	1	0	rel.	abs.
0	0	0	0	NanoPro	
0	0	0	1	10 %	0.4 A
0	0	1	0	20 %	0.8 A
0	0	1	1	30 %	1.2 A
0	1	0	0	40 %	1.6 A
0	1	0	1	50 %	2 A
0	1	1	0	60 %	2.4 A
0	1	1	1	70 %	2.8 A
1	0	0	0	80 %	3.2 A
1	0	0	1	90 %	3.6 A
1	0	1	0	100 %	4 A
1	0	1	1	110 %	4.4 A
1	1	0	0	120 %	4.6 A
1	1	0	1	130 %	4.8 A
1	1	1	0	140 %	5.2 A
1	1	1	1	150 %	6 A

3.5 RS232 interface: Connector X1

Introduction

The controller has a serial TTL RS232 interface (3.3 V) for connecting to a PC.

Converter cable

Use the converter cable
ZK-RS232-USB-3.3V for connection to the USB port of the PC.

Pin assignment

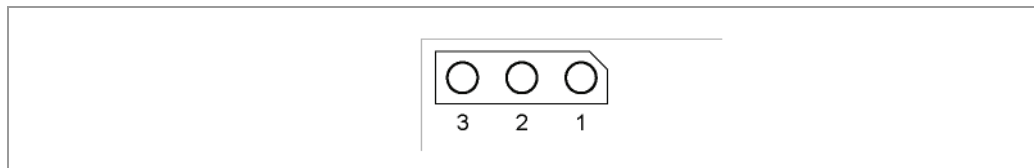

Pin no.	Name	Observations
1	GND	Black
2	Tx	Yellow
3	Rx	Orange

4 Operating modes

Introduction

Depending on the travel profile, the motor can be operated using different operating modes. Due to the great capacity and functions available, it offers designers and developers a rapid and simple method of resolving numerous drive requirements with less programming effort.

Select the required operating mode for each drive profile and configure the controller according to your requirements.

More detailed information can be found in the separate NanoPro manual.

Overview of operating modes and their areas of application

Operation mode	Application
Relative positioning	Use this mode when you wish to travel to a specific position. The motor travels according to a specified drive profile from a Position A to a Position B.
Absolute positioning	
Internal reference run	During the internal reference run, the motor travels to an internal reference point (the index mark of the encoder) at the set minimum speed.
External reference run	During an external reference run, the motor travels to a switch connected to the reference input.
Speed mode	Use this mode when you wish to travel with a specific speed (e.g. a conveyor belt or pump speed). In the speed mode, the motor accelerates with a specified ramp from the starting speed (start frequency "V Start") to the specified maximum speed (maximum frequency "V Normal"). Several inputs enable the speed to be changed on-the-fly to different speeds.
Flag positioning mode	The flag positioning mode offers a combination of the speed and positioning modes. The motor is initially operated in speed mode; when a trigger point is reached, it changes to the positioning mode and the specified setpoint position (relative to the trigger position) is approached. This operating mode is used for labeling, for example: the motor first travels with the set ramp to the synchronous speed of the conveyed goods. When the labels are detected, the preset distance (position) is traveled to apply the labels.

Operation mode	Application
Clock direction mode left/right	Use this mode when you wish to operate the motor with a superordinate controller (e.g. CNC controller). In the clock direction mode, the motor is operated via two inputs with a clock and a direction signal from a superordinate positioning control (indexer).
Analog and joystick mode	The speed setting of the motor is performed in this operating mode simply with a potentiometer or a joystick (–10 V to +10 V). Use this mode if you want to use the motor in a simple application: <ul style="list-style-type: none"> • Setting a specific speed, e.g. via an external potentiometer, • Traveling synchronously with a superordinate controller with analog output (–10 V to +10 V).
Analogue positioning mode	Use this mode when you wish to travel to a specific position. The voltage level on the analog input is proportional to the required position.
Torque mode	Use this mode when you require a specific output torque independent of the speed as is the case in typical winding and unwinding applications. The maximum torque is specified via the analog input.

Selecting the operating mode in NanoPro

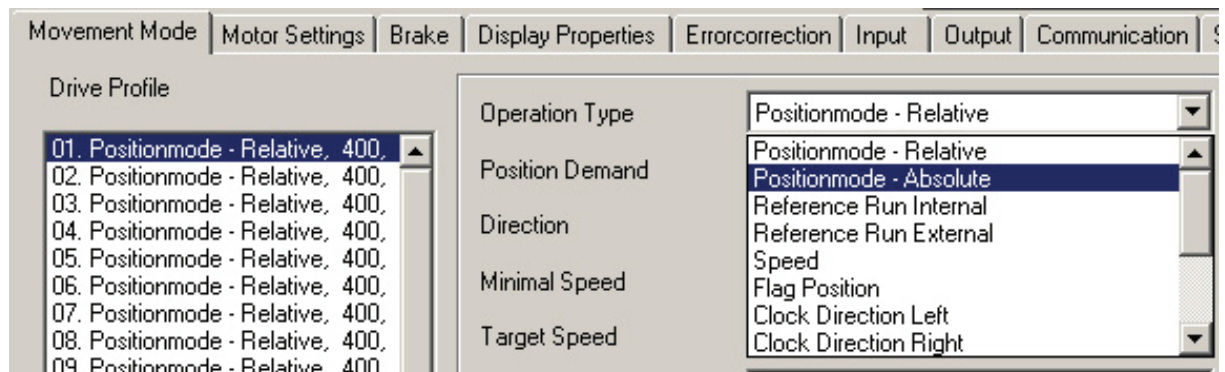

5 Troubleshooting

Troubleshooting procedure

Proceed with care during troubleshooting and error rectification to avoid damaging the controller.

	<p>Danger of electrical surges</p> <p>An operating voltage > 50 V and incorrect connections can destroy the end stage. Never disconnect the motor when operating voltage is applied! Never disconnect lines when live!</p>
---	--

Possible error

Error	Possible cause	Rectification
Controller is not ready	Data transmission to SMCI35 is not possible (communication error): Incorrect COM port selected.	In the <Communication> tab, select the PC port to which you connected the SMCI35 (e.g. "COM-1"). The port used can be found in the device manager of your PC.
	Wrong baud rate setting.	Select the baud rate 115200 bps in the <Communication> tab.
	Communication cable not connected or interrupted (incorrect converter used).	Use the recommended converter from Nanotec: <ul style="list-style-type: none"> Order identifier: ZK-RS232-USB-3.3V
	A non-existent motor number (module number) is set.	Set the correct module address. See the separate manual on NanoPro.
	The power supply of the SMCI35 is interrupted.	Check voltage supply, switch on if necessary.
	Another open program is blocking the COM port to which the SMCI35 is connected.	Close down other programs on your PC.
	Inadmissible data was sent to the controller during the output of a travel profile.	Click on the <Yes> button to stop the travel profile. The SMCI35 switches back to the "Ready" state. The data can then be resent to the controller.
Transmission error	Data transmission to the SMCI35 is disturbed (sender or receiver are disturbed).	Check the possible causes for the transmission error and rectify the cause of the error.
Position error	The motor cannot reach the position or the limit switch was overrun.	Click the <Yes> button in the error message; the error is reset.

6 Technical data

Electrical connections

Operating voltage V_b	DC 12 V to 48 V $\pm 4\%$
Max. phase current	Adjustable up to max. 6 A/phase Continuous current 4 A/phase
Current drop	Adjustable 0 to 150% of rated current
Interface	TTL-RS232 (3.3 V)

Controller parameters

Step resolution	Full step, half step, quarter step, fifth step, eighth step, tenth step, 16th step, 32nd step, 64th step, adaptive microstep, feed rate
Step frequency	16 kHz with a full step, corresponding multiples with a microstep (e.g. 1 MHz with 1/64) Max. input frequency, clock direction mode: 200 kHz
Position monitoring	depending on encoder resolution

Protective circuits

Overvoltage and undervoltage	Protection circuit for voltage > 50 V or < 10 V
Max. heat sink temperature	Approx. 80 °C
Max. ambient temperature	0 to 40 °C

Inputs and outputs

Inputs	<ul style="list-style-type: none"> • 6 digital inputs (TTL, max. 5 V) • 1 analog input (+10 V / -10 V)
Outputs	<ul style="list-style-type: none"> • 3 digital outputs (TTL, +5 V, 20 mA)

SMCI35 dimensions

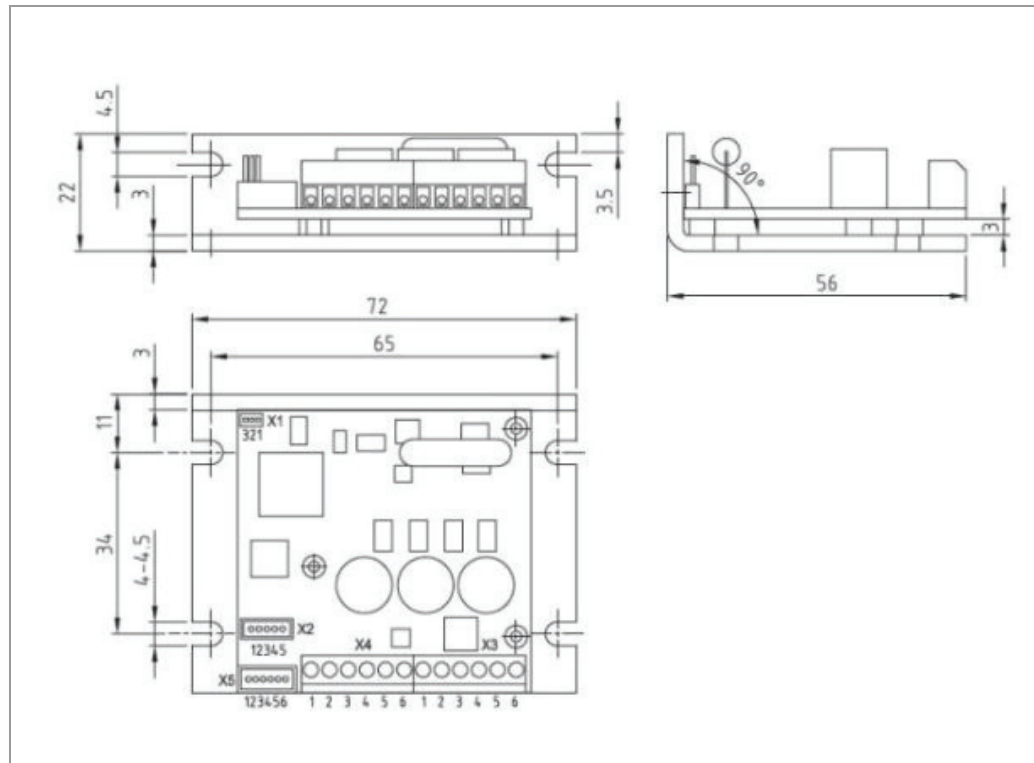

A complete set of datasheets is available for downloading at www.nanotec.com.

Connectors

The following connectors are available on the SMCI35:

- Connector X1: Pin connector 2.54
- Connector X2 and X5: JST-ZH
- Connector X3 and X4: RIA 059

Overtemperature protection

At a temperature of approx. 75°C, the power drive of the controller is switched off and output 3 is switch on. After the controller is cooled and restarted, it operates normally again.

Temperature tests were performed under the following conditions:

- Operating voltage: 24 V/48 V DC
- Motor current: 100% (4 A)/150% (6 A)
- Operation mode: Full step speed mode, 25 rpm and 0 rpm
- Operating environment: Binder FED 53 temperature cabinet, circulated air at 100% fan speed
- Ambient temperature: 45 °C (50 °C, 55 °C, 60 °C for the comparative measurement)
- Measurement point: Rear of controller for power transistors, on outside of housing

The following graphics show the temperature test results:

Operating voltage 24 V

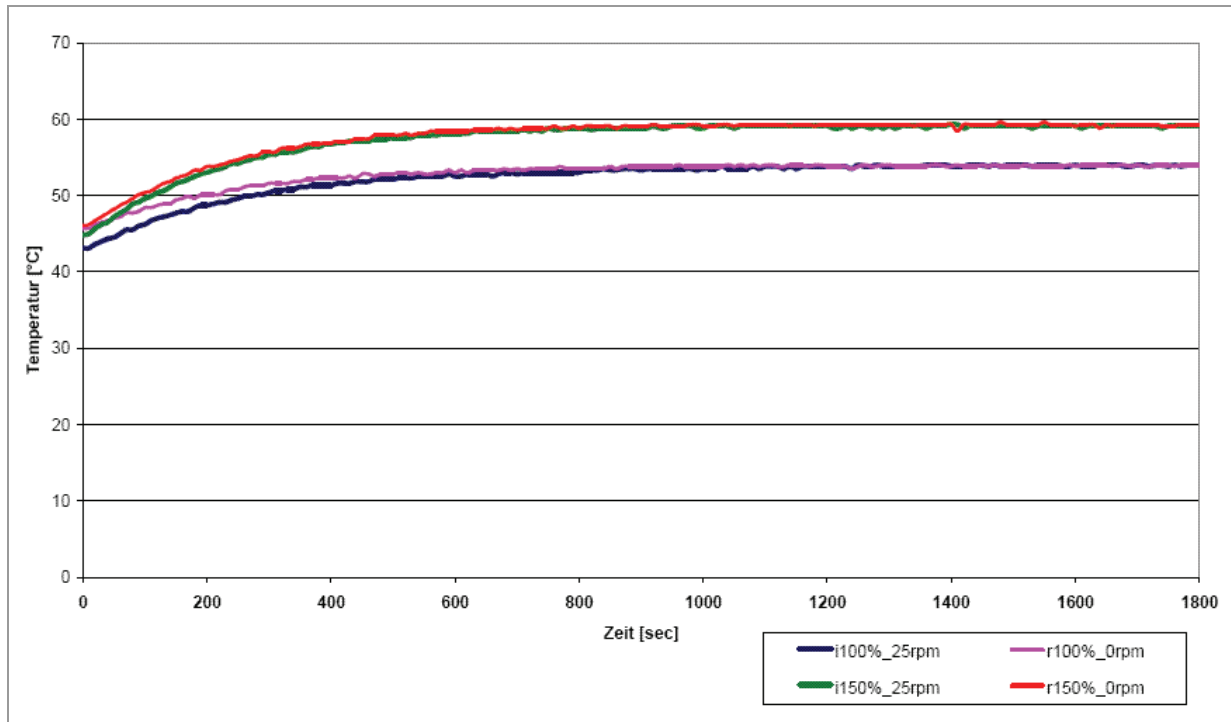

Operating voltage 48 V

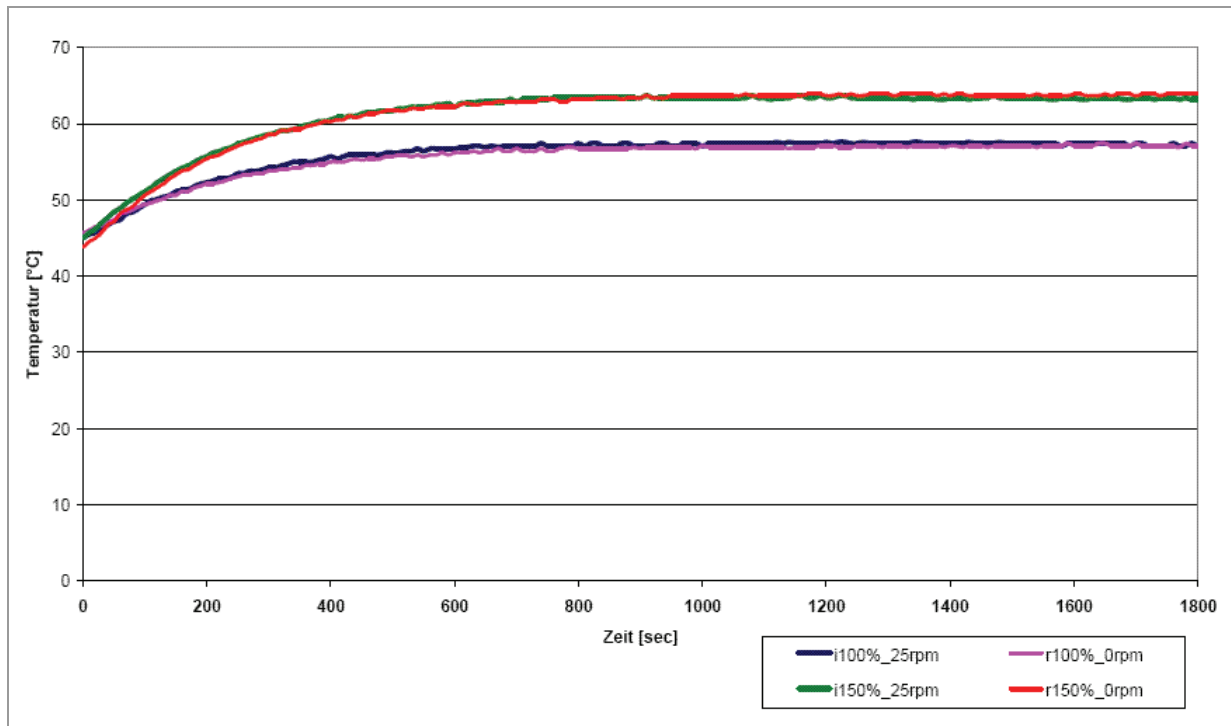

Comparative temperature measurement (48 V, motor current 150%)

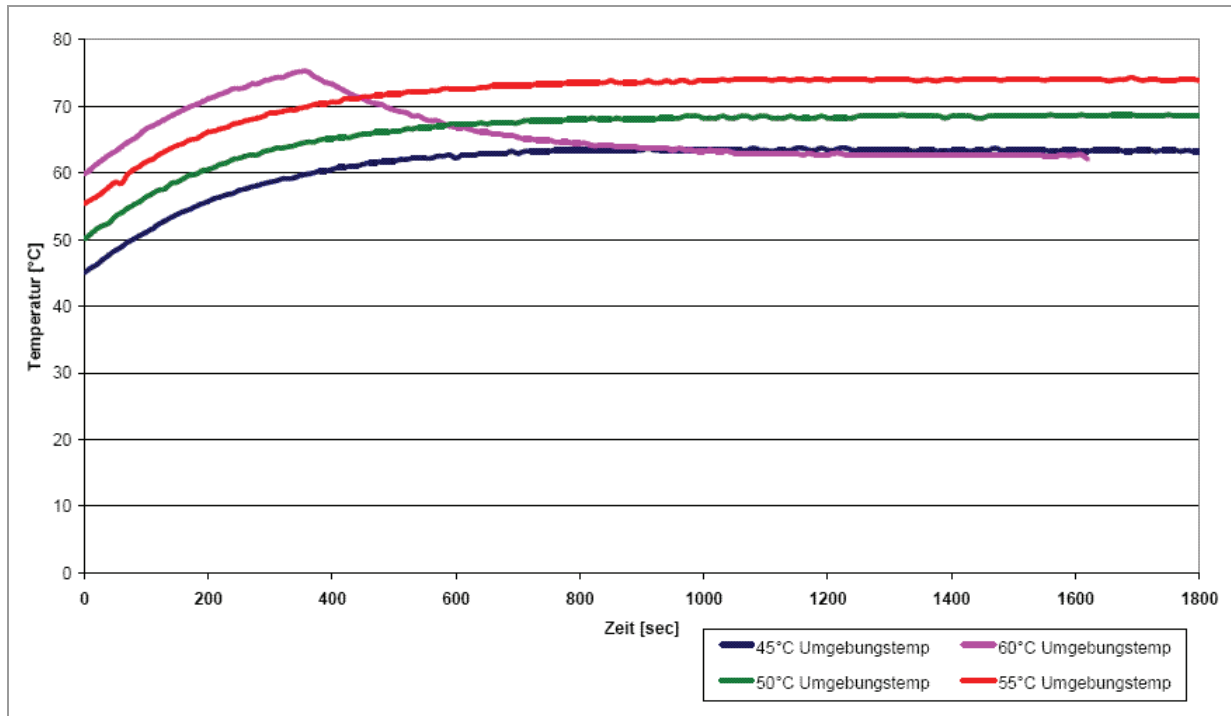

Index

A

Accessories for voltage supply 17

B

BLDC motor 9

C

Closed-Loop current control 5

Commissioning 10

D

DIP switch 18

dspDrive 6

E

Encoder 14

F

Functions 5

H

Hall sensors 13

I

Input circuits 13

Inputs 12

M

Motor connection

 BLDC motor 16

 Stepper motor 16

Motor current 18

N

NanoJ 6

O

Operating modes 20

Operating voltage 17

Output circuits 14

Outputs 12

Overtemperature protection 24

P

Phase current 18

Pin assignment of X1 connector 19

Pin assignment of X2 connector 14

Pin assignment of X3 connector 16

Pin assignment of X4 connector 12

Pin assignment of X5 connector 12

Plug connections 7

Protective circuits 23, 24

R

RS232 interface 19

V

Voltage supply 17