

Technical Manual



Stepper driver SMC147

NANOTEC ELECTRONIC GmbH & Co. KG
Gewerbstraße 11
D-85652 Landsham near Munich, Germany

Tel. +49 (0)89-900 686-0
Fax +49 (0)89-900 686-50
info@nanotec.com

Editorial/About this manual

© 2009

Nanotec® Electronic GmbH & Co. KG

Gewerbestraße 11

D-85652 Landsham / Pliening, Germany

Tel.: +49 (0)89-900 686-0

Fax: +49 (0)89-900 686-50

Internet: www.nanotec.com

All rights reserved!

MS-Windows 2000/XP/Vista are registered trademarks of Microsoft Corporation.

Thank you for choosing a Nanotec stepper driver!

Target group

This technical manual is aimed at designers and developers who need to operate a Nanotec® stepper motor without much experience in stepper motor technology.

About this manual

This technical manual must be carefully read before installation and commissioning of the driver.

Nanotec® reserves the right to make technical alterations and further develop hardware and software in the interests of its customers to improve the function of this product without prior notice.

This manual has been written with due care. It is exclusively intended as a technical description of the product and as commissioning instructions. The warranty is exclusively for repair or replacement of defective equipment, according to our general terms and conditions, liability for subsequent damage or errors is excluded. Applicable standards and regulations must be complied with during installation of the device.

For criticisms, proposals and suggestions for improvement, please contact the above address or send an email to: info@nanotec.com

Version/Change overview

Version	Date	Changes
0.7	2008-04-01	New issue/Previous version
1.0	2008-06-16	Revision C+P
1.1	2009-02-13	Revision C+P

Contents

1	Overview	5
2	Connection and commissioning	6
2.1	Connection diagram	6
2.2	Commissioning.....	8
3	Connections and circuits	10
3.1	Inputs and outputs (I/O): Connector X1	10
3.2	Encoder connection: Connector X2	12
3.3	Stepper motor connection: Connector X3.....	13
3.4	Voltage supply connection: Connector X4	15
3.5	Interface connection RS485 network: Connector X5.....	16
4	The NANOPRO driver software	19
4.1	General information.....	19
4.2	Installing NANOPRO.....	19
4.3	NANOPRO operating interface	20
4.3.1	Overview	20
4.3.2	The menu bar.....	20
4.3.3	The menu window	22
5	Operating modes.....	23
5.1	Overview	23
5.2	Entering profile parameters.....	25
5.3	Positioning mode.....	29
5.3.1	Description	29
5.3.2	Input and output assignments.....	30
5.3.3	Profile parameters.....	31
5.3.4	Signal curves in positioning mode	33
5.4	Speed mode.....	34
5.4.1	Description	34
5.4.2	Input and output assignments.....	35
5.4.3	Profile parameters.....	36
5.4.4	Signal curves in speed mode.....	37
5.5	Flag positioning mode.....	38
5.5.1	Description	38
5.5.2	Input and output assignments.....	39
5.5.3	Profile parameters.....	40
5.5.4	Signal curves in flag positioning mode.....	41
5.6	Clock direction mode.....	42
5.6.1	Description	42
5.6.2	Functions of the inputs and outputs.....	42
5.6.3	Profile parameters.....	43

5.6.4	Signal curves in clock direction mode.....	44
5.7	Analogue and Joystick mode.....	45
5.7.1	Description.....	45
5.7.2	Functions of the inputs and outputs.....	46
5.7.3	Circuit.....	47
5.7.4	Profile parameters.....	47
5.8	Analogue positioning mode (Beta version).....	48
5.8.1	Description.....	48
5.8.2	Functions of the inputs and outputs.....	48
5.8.3	Profile parameters.....	49
5.8.4	Motor Settings.....	49
6	Reference runs and limit switch behaviour	50
6.1	External and internal reference runs and limit switch behaviour.....	50
6.2	Setting the limit switch behaviour.....	53
7	Settings	54
7.1	Overview.....	54
7.2	"Motor Settings" tab.....	55
7.3	"Generic" tab.....	57
7.4	"Errorcorrection" tab.....	58
7.5	"I/O" tab (Beta version).....	61
7.6	"Communication" tab.....	64
7.7	"Statusdisplay" tab.....	65
7.8	Operating several motors.....	66
8	Troubleshooting.....	67
8.1	General information.....	67
8.2	Error messages.....	68
8.3	Troubleshooting.....	70
9	Technical data	71
9.1	Technical data.....	71
9.2	Dimensions and connectors.....	73
Index		74

1 Overview

Introduction

The stepper driver SMCI47 is an extremely compact and cost-effective constant current power end stage with integrated **Closed-Loop** positioning or speed control.

Due to the great capacity and functions available, it offers designers and developers a rapid and simple method of resolving numerous drive requirements with less programming effort.

It is used for controlling standard stepper motors (including with attached encoders) or motors with integrated encoders or brakes.

The SMCI47



SMCI47 functions

The stepper driver SMCI47 contains the following functions:

- Microstep 1/1 – 1/64 Final output stage (0.014° step resolution)
- Powerful DSP microprocessor for flexible I/O
- Rotation monitoring for optional encoder
- RS485 interface for parameterization and control (USB connection possible via converter cable ZK-RS485-USB)
- Network capability of up to 32 motors
- Easy programming with the Windows software NANOPRO

Operating modes

The following operating modes can be selected:

- Positioning
- Speed
- Flag positioning
- Clock direction
- Analogue or joystick operation (± 10 V)
- Analogue positioning mode

Function overview

The operating behaviour of the motor can be set and optimised according to individual requirements by setting the motor-related parameters such as phase current (selectable in 1% increments), step resolution (from 1.8° - 0.014°), as well as the adaptive microstep (automatic adaption of step width). Machine-related parameters can be set using the NANOPRO software and significantly reduce commissioning time:

- Distance in steps, degrees or mm
- Speed in Hertz, rpm or mm/s
- Feed constant in mm/revolution
- Gear reduction with reverse clearance

Three adjustable reference modes (external and internal) enable automatic machine settings, whereby external reference switches may be inapplicable if there is a shift $< 360^\circ$ possibly due to the index signal of the internal encoder.

Even if stepper motors do not lose steps during normal operation, the integrated speed control provides additional security in all operating modes, e.g. against motor stalling or other external sources of error. The monitoring function detects a stalled motor or step loss after half a step at the most (for 1.8° stepper motors).

Automatic error correction is possible after the drive profile is ended or during the drive.

2 Connection and commissioning

2.1 Connection diagram

Introduction

To operate a stepper motor with the SMC147 stepper driver, the wiring must be implemented according to the following connection diagram.

Inputs (Pin 1 to 6) on the connector X1 and the encoder input (connector X2) can be used optionally.

Connection diagram SMCI47

Nanotec / Connection diagram / SMCI 47-2 (RS 485)

Speed and positioning control (Closed Loop) via

- a) PC - for control and parameterization of c), d) and e)
- b) Industrial control system
- c) SPS - e.g. Logo or Easy
- d) Analog / Joystick
- e) Stand alone - via external switch

X 1 - Inputs and outputs

d) Analog input



e) Inputs (+5 V / 24V on request)

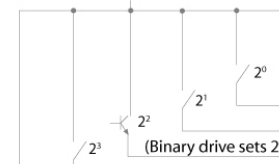

Outputs (5-30 V / max. 10 mA)

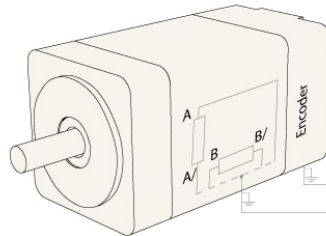
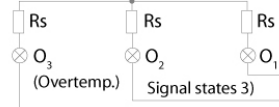

Shielding

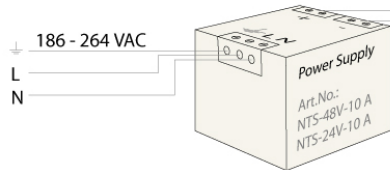

10000 µF
Art.No.: Z-K10000

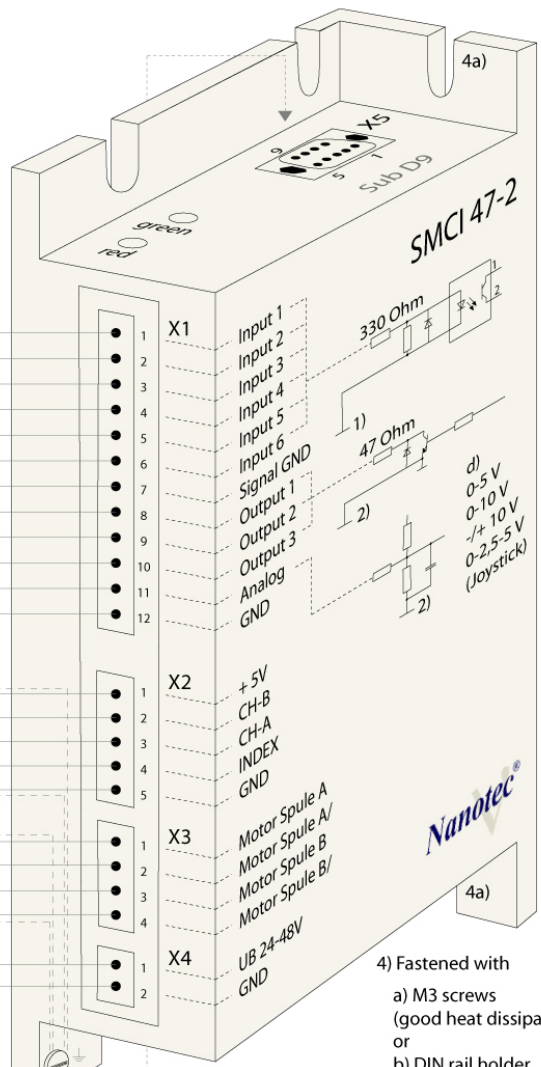

- 4) Fastened with
 - a) M3 screws (good heat dissipation)
 - or
 - b) DIN rail holder

X1 - X2 (mating connector)
Type Phoenix FK 5/12
X3 - X4 (mating connector)
Type Phoenix FK 2/4

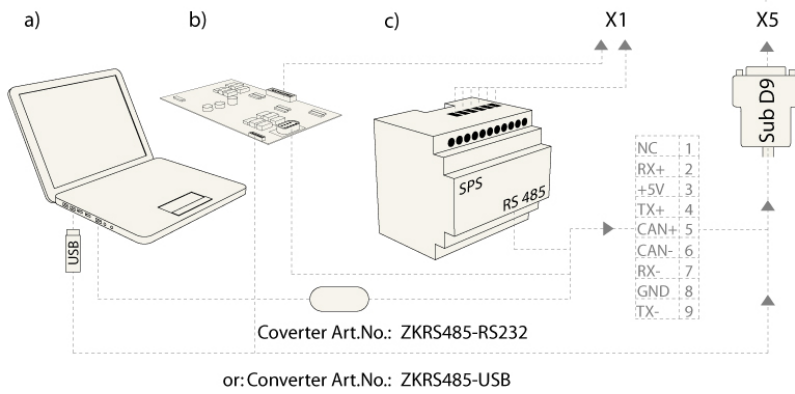

3)

O ₃	O ₂	O ₁	Signal states Output 1 and 2
0	0	0	Rotary monitoring (Error) or limit switch
0	0	1	Motor idle (waiting for new command)
1	0	0	Busy (control processing last command)
1	1	1	Reference point or zero point reached
1			Overtemperature

2.2 Commissioning

Provisions

The connection and commissioning of the SMCI47 stepper motor are described below.

You will find the main "First Steps" here to start working rapidly with the SMCI47 if you are using the NANOPRO software from a PC.

If you want to work at a later time with a PLC or your own program, you will find the necessary information in the separate "Command Reference".

Familiarise yourself with the SMCI47 stepper driver and the corresponding control software NANOPRO before you configure the driver for your application.

Procedure

Proceed as follows to commission the driver:

Step	Action	Note
1	Install the driver software NANOPRO on your PC.	Download from www.nanotec.com/downloads . See Section 4.2 „Installing NANOPRO“.
2	Connect the driver to the stepper motor according to the connection diagram.	Connection diagram, see Section 2.1. Detailed information on connections can be found in Chapter 3 „Connections and circuits“.
3	Switch on the operating voltage (24 V DC ... 48 V DC).	The green LED lights up.
4	Connect the driver with your PC. Use one of the following converter cables for this purpose: <ul style="list-style-type: none"> • ZK-RS485-RS232 for connection to the serial interface • ZK-RS485-USB for connection to the USB interface 	Order number: <ul style="list-style-type: none"> • ZK-RS485-RS232 • ZK-RS485-USB Note: Download the necessary driver from www.nanotec.com under the menu item Accessories/Converter.
5	Start the NANOPRO software.	The NANOPRO main menu appears.
6	Select the "Communication" tab.	

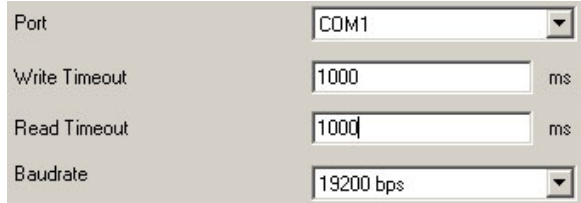
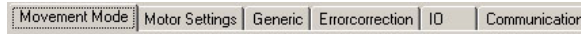
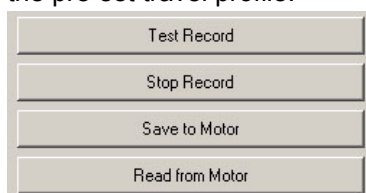
Step	Action	Note
7	<p>In the field "Port", select the COM port to which the SMCI47 is connected.</p> 	<p>The number of the COM port to which the driver is connected can be found in the device manager of your Windows' PC.</p>
8	<p>Select the entry "19200 bps" in the selection field "Baudrate".</p>	
9	<p>Select the "Movement Mode" tab.</p> 	
10	<p>Click on the button <Test Record> to carry out the pre-set travel profile.</p> 	<p>The connected motor operates with the pre-set travel profile (default travel profile after new installation).</p>
11	<p>You can now enter your required settings. For instance, you can enter a new travel profile.</p>	<p>To do this, see the following chapters in this manual:</p> <ul style="list-style-type: none"> • Chapter 4 „The NANOPRO driver software“, • Chapter 5 „Operating modes“, • Chapter 6 „Reference runs and limit switch behaviour“ or • Chapter 7 „Settings“.

3 Connections and circuits

3.1 Inputs and outputs (I/O): Connector X1

Introduction

An overview of the assignments can be found in the connection diagram in Section 2.1.. This section looks in detail at the assignment, functions and circuits of the connector X1..

The connectors and sockets used are from Phönix, Order number: FK-MC 2/4/5/12.

Connection diagram inputs and outputs (I/O) (X1)

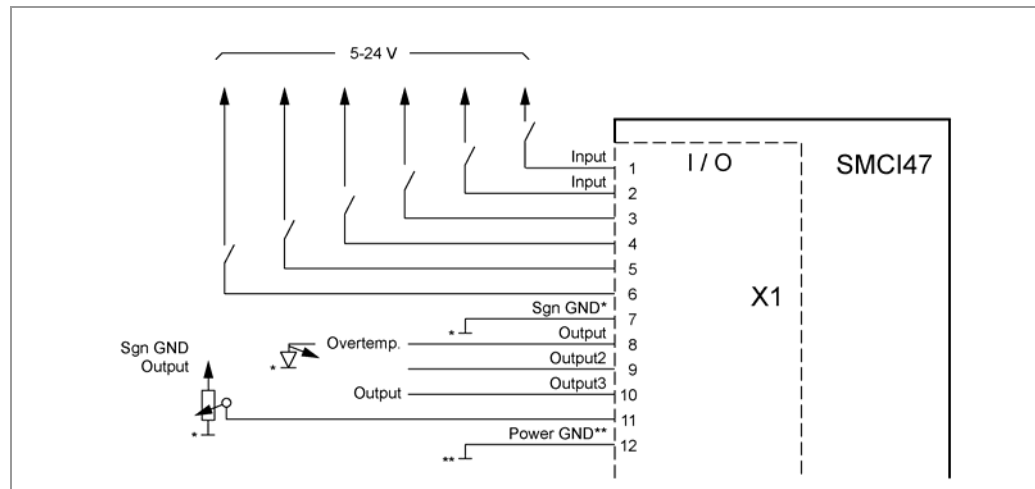

Pin assignment connector X1: Inputs and outputs (I/O)

Pin-No.	Name	Observations	Operating mode					
			Position	Speed	Flag position	Clock direction	Analogue	Joystick
1	Input1	+5 V Optocoupler	Start Reset	Enable	Start	Enable	Enable	Enable
2	Input2	+5 V Optocoupler	Travel profile	Speed	Travel profile	Manual mode	Speed	Speed
3	Input3	+5 V Optocoupler	Travel profile	Speed	Travel profile	Manual mode	Speed	Speed
4	Input4	+5 V Optocoupler	Travel profile	Speed	Travel profile	Ext. limit switch	Speed	Speed
5	Input5	+5 V Optocoupler	Travel profile	Speed	Trigger	Direction	Speed	Speed
6	Input6	+5 V Optocoupler	Ext. limit switch	Direction	Ext. limit switch	Clock	Direction	
7	Com	Signal GND						
8	Output1	Open-Collector						
9	Output2	Open-Collector						
10	Output3	Open-Collector						
11	Analogue In	-10 V ... +10 V					Analogue In	Analogue In
12	GND	Power & Analogue GND						

Note:

The Com and GND connections are not joined. Com provides the mass for the inputs and GND provides the mass for the outputs and the internal circuits.

Input circuits

All inputs (apart from the "Analogue In" input) are electrically isolated by optocouplers from the voltage supply of the SMC147 and designed for 5 V input signals at an input current of 10 mA. With the SMC147-S a new 24V version will also be introduced.

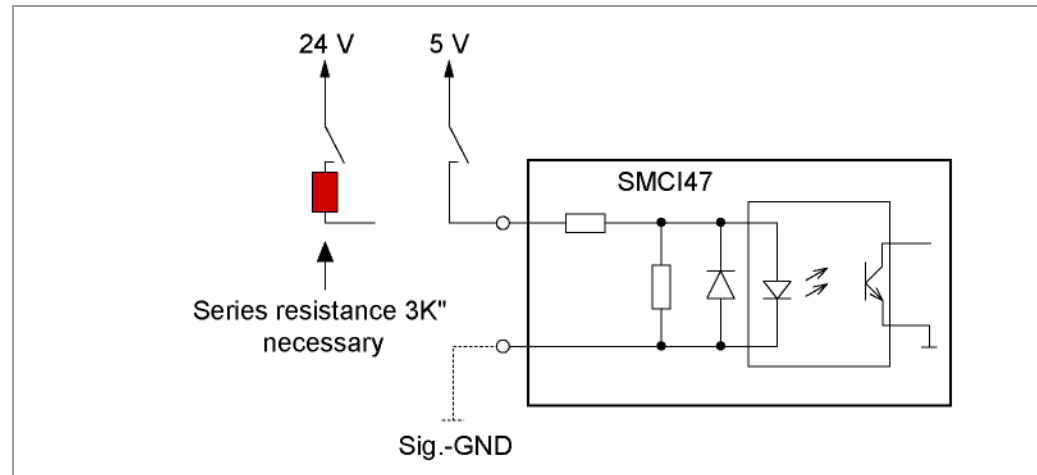

Output circuits

The outputs are transistor outputs in Open-Collector circuits (0 switching, max. 30 V / 10 mA). An LED can be integrated to test the output. The LED lights up when the output is active.

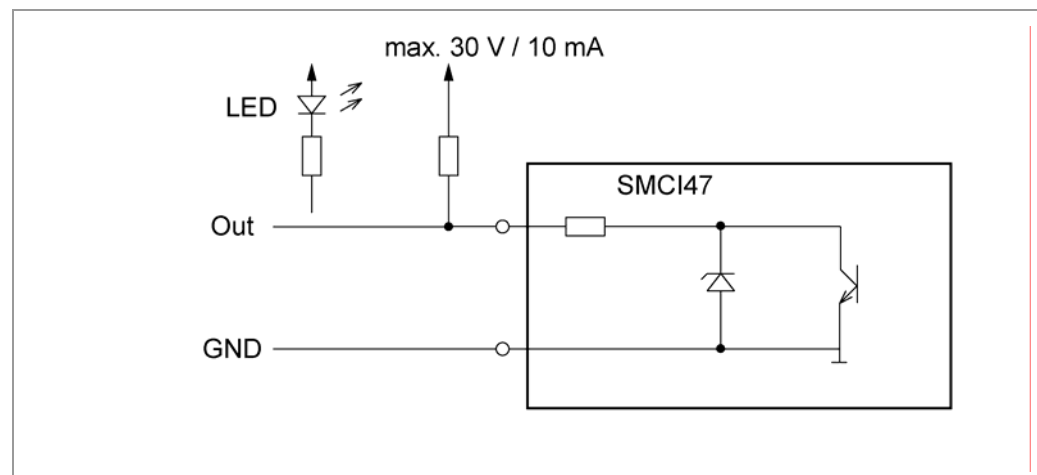

3.2 Encoder connection: Connector X2

Optional encoder

An optional encoder can be connected to the stepper driver.

Only 3-channel encoders with 500 pulses/revolution can be connected.

Recommended:

Where possible, use Nanotec encoders with the order number HEDS-5540 Axx.

If an encoder is **not** used, the mode "Ignore" must be set in the selection menu "Encoder monitoring mode" in the menu "Motor settings". Please refer to Section 7.4 „Errorcorrection" tab“.

Encoder connection diagram (X2)

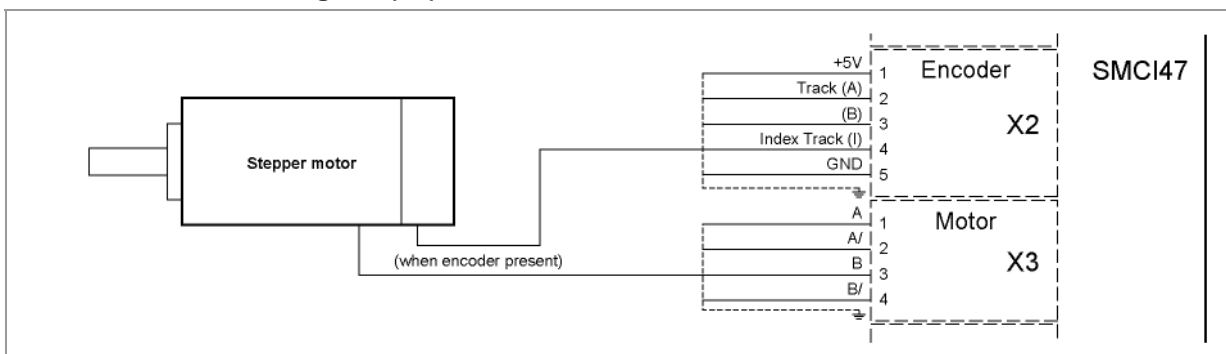

Note:

Complete connection diagram - see Section 2.1.

Pin assignment connector X2: Encoder

Pin-No.	Name	Observations
1	+5 V	
2	Track (A)	
3	Track (B)	
4	Index track (I)	
5	GND	

3.3 Stepper motor connection: Connector X3

General information

The motor is connected to the SMCI47 with a 4-wire cable. Twisted wire pair cables with braided shields are recommended.

	<p>Danger of electrical surges</p> <p>Mixing up the connections can destroy the output stage!</p> <p>Never disconnect the link when operating voltage is applied!</p> <p>Never disconnect lines when live!</p>
---	--

Connection diagram stepper motor (X3)

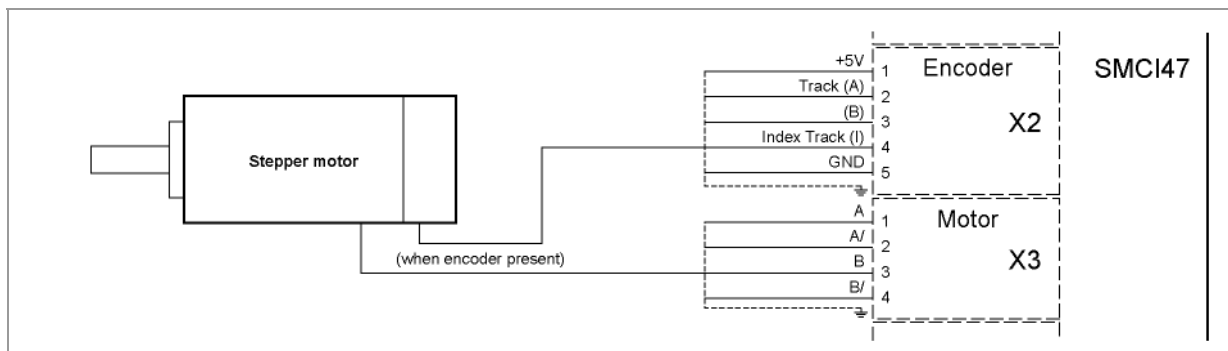

Note:
Complete connection diagram - see Section 2.1.

Pin assignment connector X3: Stepper motor

Pin-No.	Name	Observations
1	A	See also data sheet of connected stepper motor (colour code of 4 wires).
2	A/	
3	B	
4	B/	

If you are using a motor with 6 or 8 connections, you need to connect the windings.

The diagram on the next page shows four wiring plans for motors with 6 or 8 connections (page from the Nanotec product catalogue).

Details can be found on the Nanotec website www.nanotec.com.

8 lead wire - parallel for high frequency > 1 kHz

current per winding x 1,4 = current per Phase
 example: current / winding 1A = 1,4A / Phase

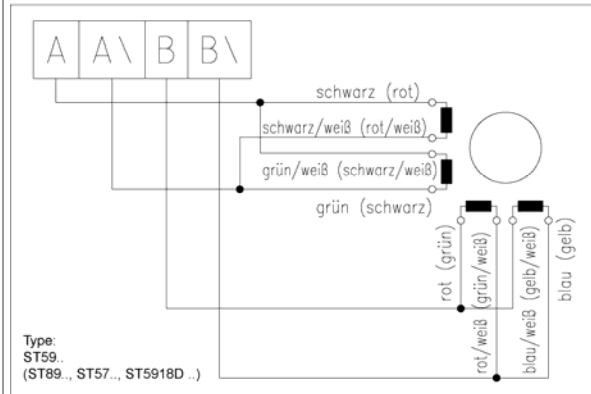

8 lead wire - serial for low frequency < 1 kHz

current per winding x 0,7 = current per Phase
 example: current / winding 1A = 0,7A / Phase

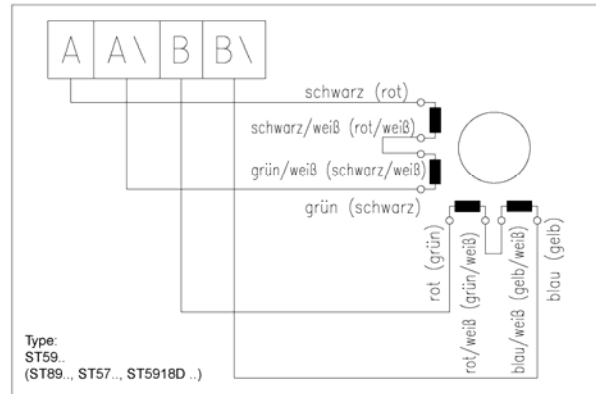

6 lead wire

current per winding = current per Phase
 example: current / winding 1A = 1A / Phase

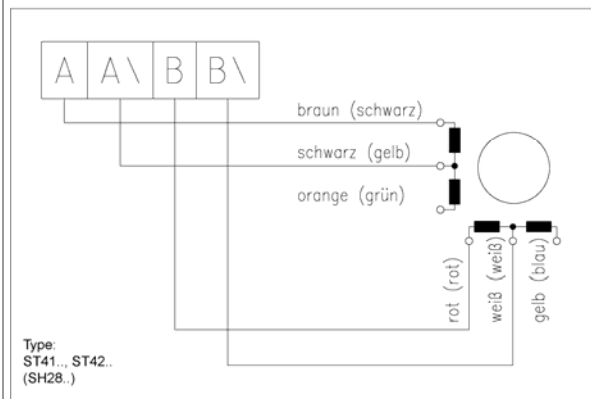

current per winding x 0,7 = current per Phase
 example: current / winding 1A = 0,7A / Phase

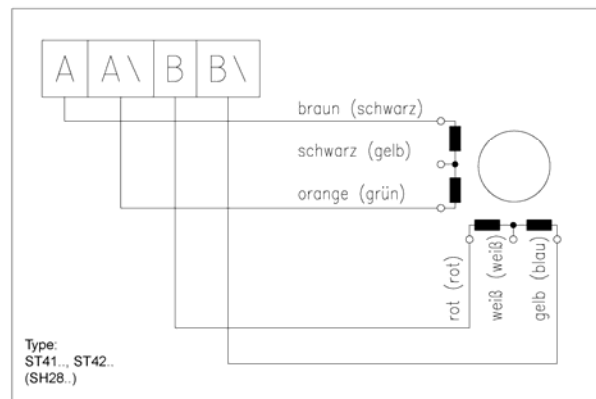

4 lead wire

current per winding = current per Phase
 example: current / winding 1A = 1A / Phase

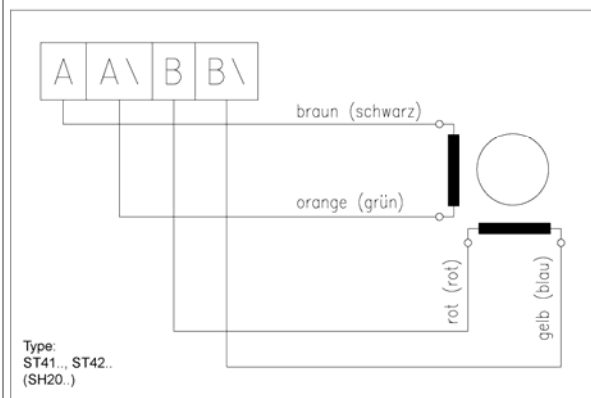

current per winding = current per Phase
 example: current / winding 1A = 1A / Phase

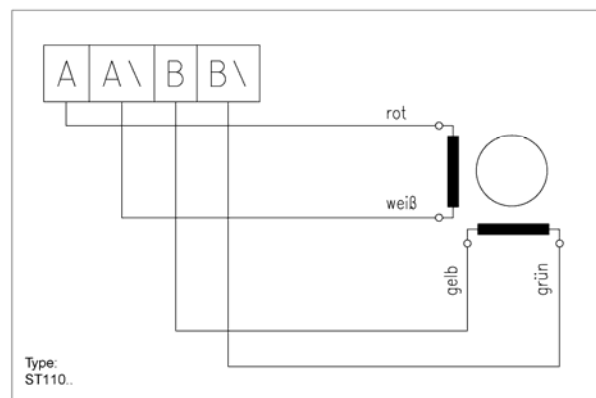

3.4 Voltage supply connection: Connector X4

Permissible operating voltage

The permissible operating voltage for the SMC147 stepper driver lies between +24 and +48 V DC; it must not exceed 50 V or fall below 21 V .

A charging condenser with minimum 4700 µF (10000 µF) must be provided for the operating voltage to prevent exceeding the permissible operating voltage (e.g. during braking).

	<p>Danger of electrical surges</p> <p>Connect charging condenser with minimum 4700 µF! Connect a condenser with 10000µF for motors with flange size 86x86 (series ST8918) or greater!</p> <p>An operating voltage > 50 V will destroy the output stage! Mixing up the connections can destroy the output stage! Never disconnect the link when operating voltage is applied! Never disconnect lines when live!</p>
---	---

Connection diagram voltage supply (X4)

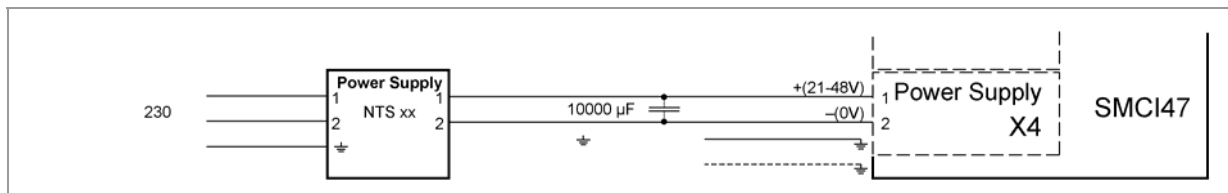

Note:
Complete connection diagram - see Section 2.1.

Voltage supply connections: Connector X4

Pin-No.	Name	Observations
1	Vcc	Switch on the operating voltage (+24 V DC ... +48 V DC)
2	GND	Earth (0 V)

Accessories for voltage supply

Appropriate power packs and charging condensers are available as accessories:

Name	Order number
Power pack	NTS-xxV-xA
Charging condenser	Z-K4700 or Z-K10000

Note:
Further information about accessories can be found on the Nanotec website:
www.nanotec.com

3.5 Interface connection RS485 network: Connector X5

SMCI47 in a network

Up to 32 stepper drivers can be controlled in a network from a PC or PLC.

These network connections are set up via the RS485 interface.

RS485 interface (D-Sub socket connector): Connector X5

A 9 pin D-Sub socket connector is located on the top of the SMCI47 (connector X5).
The connector X5 provides the optional connection to the RS485 network.

RS485 socket connector

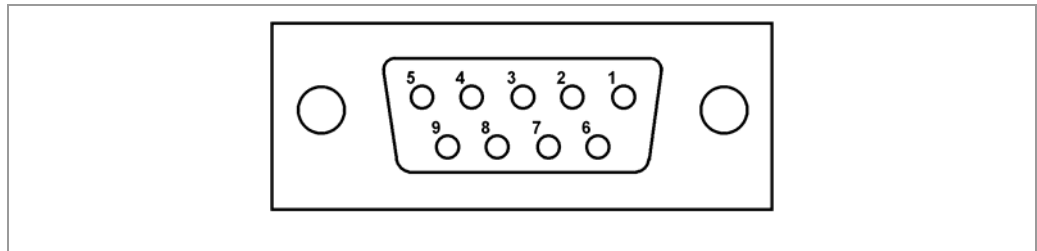

Pin assignment connector X5: RS485 interface

Pin-No.	Name	Observations
1	NC	not assigned
2	A	RS-485 Rx+
3	+5 V	Output +5 V
4	Y	RS-485 Tx+
5	NC	
6	NC	
7	B	RS-485 Rx-
8	GND	Output GND (0 V)
9	Z	RS-485 Tx-

Circuit diagram RS485 network

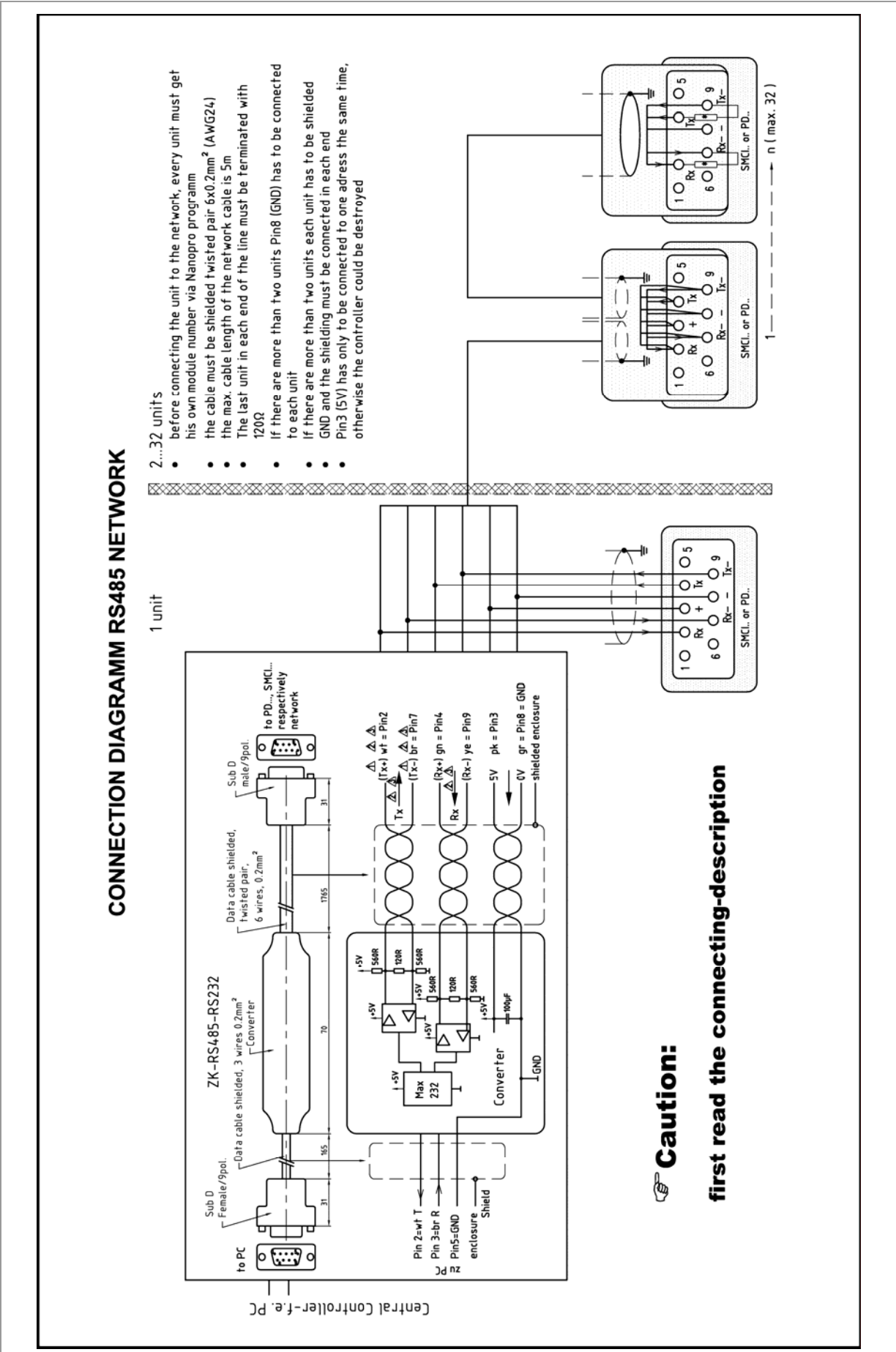

Connection requirements

- The RS485 4-wire bus is used as a pure Master-Slave application. All SMCI47 are connected in parallel as Slaves to the bus.
- Up to 32 stations can be operated on the network.
- The length of the connection lines (stub lines) must be as short as possible and should not exceed 5 m.
- To avoid reflections during data transmissions, both ends of the bus line should be fitted with a 120 Ω termination resistor (typical value of the characteristic impedance of a 24 AWG twisted cable) (R1 to R4).
- To ensure a defined quiescent level, the resistances R5 to R8 must be connected permanently to the bus according to the above diagram.
- If a converter is connected between the Master and the network, only resistances R3 and R4 are necessary.
- Note the connection diagram. The output stages can be destroyed if this is not complied with.
- Use the recommended ZK-RS485-RS232 converter from Nanotec. Reliable operation cannot be guaranteed with other converters.

Two-wire operation

To enable RS-485 two-wire transmission capability, all bus stations must have a direction control.

An intelligent converter, which automatically switches to transmission mode when a start bit is received at the RS-232 interface and returns to reception mode at the end of the stop bit, enables two-wire operation of the SMCI47. This solution does not require software support.

Talk to our Technical Hotline if you require support for this.

4 The NANOPRO driver software

4.1 General information

Introduction

The driver software NANOPRO can be used to configure and program the stepper driver SMCI47 with any standard Windows PC.

Transparent interfaces and simple test functions enable rapid entry into operation and programming of the SMCI47 and facilitate commissioning.

Due to the simple operating interface, not all functions are described in this manual. Many functions are self-explanatory. Only specific operating procedures are looked at in detail.

Familiarise yourself with the operating interface of the NANOPRO driver software before starting to commission and program the SMCI47 driver.

System requirements

- MS-Windows 2000 / XP / Vista
- Free COM port on your Windows PC

Accessories required

- ZK-RS485-RS232 converter or ZK-RS485-USB converter

4.2 Installing NANOPRO

Introduction

To install the driver software NANOPRO on your PC, you must first download the software from the Nanotec website.

Download from the Nanotec website

Proceed as follows:

Step	Action
1	Open the Nanotec website in your browser: http://www.nanotec.com
2	Go to the "Downloads" area and select the following software: „Windows Software NanoPro for Plug & Drive & SMCI (NEW) >>“
3	Download the file "NanoProNG V xxx.zip" onto your PC.
4	Unpack the zip file on your PC in the required directory.
5	Open the folder "NanoProNG V xxx" and start the setup program by double-clicking on the file "NanoProNG.msi".
6	Follow the installation instructions of the setup program.

4.3 NANOPRO operating interface

4.3.1 Overview

Introduction

This section gives a brief overview of the NANOPRO driver software.

Note: If you are using NANOPRO software for the first time, familiarise yourself first with the operating interface and the control functions before starting.

Layout of operating interface

The operating interface is basically set up with a menu bar ① and a separate menu window ② for each motor.

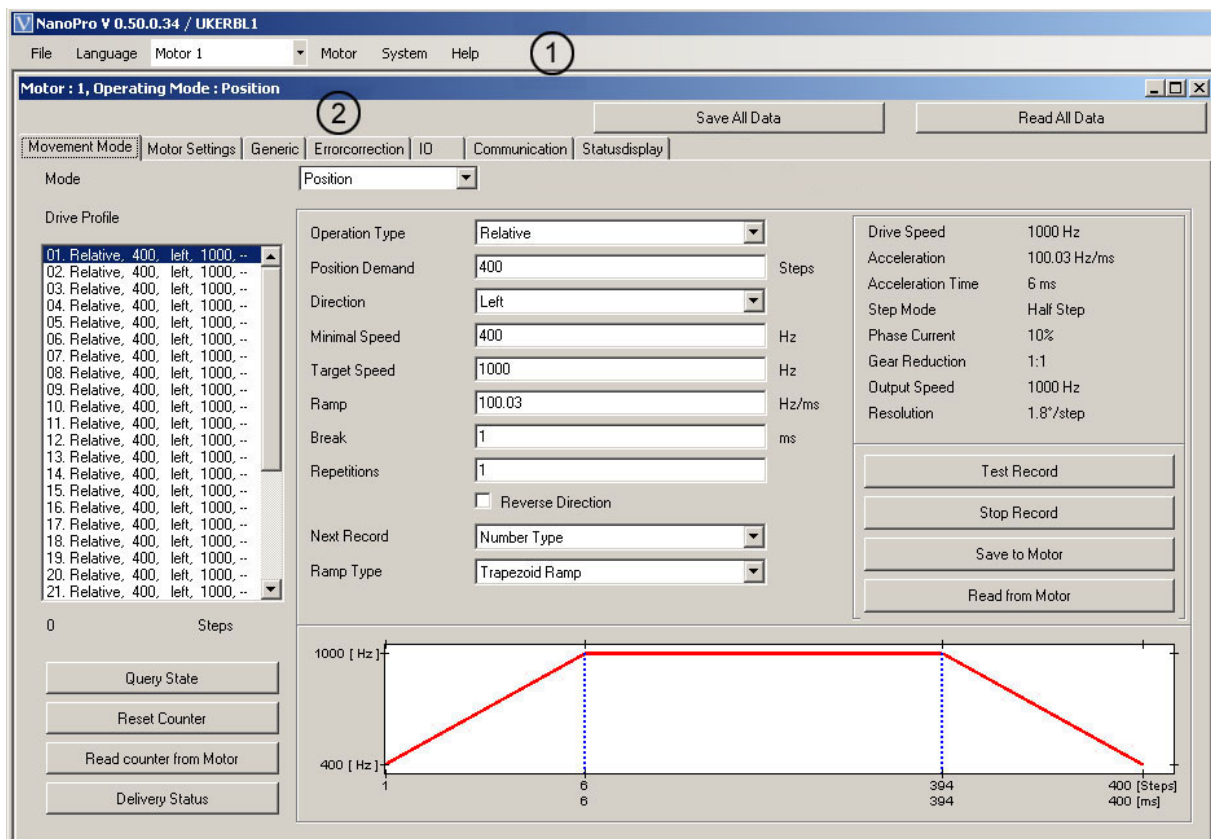

4.3.2 The menu bar

Menu <File>

Standard functions file editing.

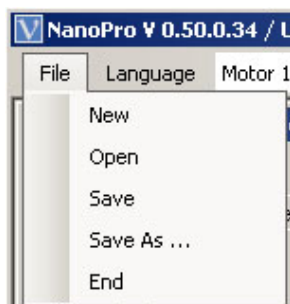

Menu <Language>

The operating interface language can be changed here (Deutsch/English).



Selection menu "Motor"

Selection of the required motor. In networks, up to 32 motors can be operated on a linked basis and actuated by the driver software NANOPRO.



Menu <Motor>

The menu <Motor> has the following menu items:

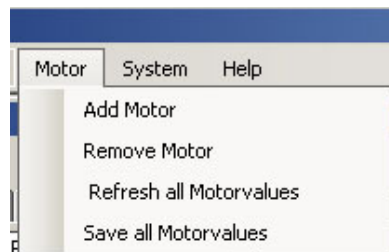

- <Add motor>:
New motors can be added via the menu item <Add motor>. This opens an input window for the motor address. The address must lie between 1 and 255.
- <Remove motor>
Motors that are no longer required can be removed from the driver in the menu item <Remove motor>. This opens a window with the query "Do you really want to delete the motor?“, which you can quit with the button <Yes>.

Menu <System>

The menu <System> has the following menu items:

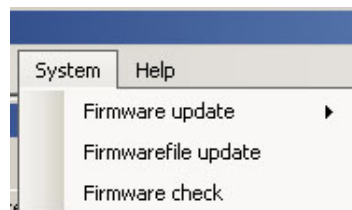

- Firmware update:
Updates the firmware for the selected motor or all motors; Downgrade for the selected motor.
- Firmwarefile update
- Firmware check

Menu <Help>

The menu <Help> has the following menu items:

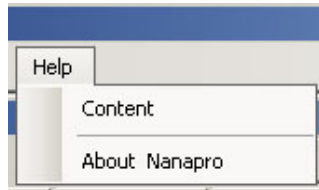

- Content:
Online help for NANOPRO
- About Nanapro:
Version information about latest installation of NANOPRO

4.3.3 The menu window

The menu window contains the following tabs:



Tab	See Section
Movement Mode	5 „Operating modes“
Motor Settings	7.2 „Motor Settings" tab“
Generic	7.3 „Generic" tab“
Errorcorrection	7.4 „Errorcorrection" tab“
I/O	7.5 „I/O" tab (Beta version)“
Communication	7.6 „Communication" tab“
Statusdisplay	7.7 „Statusdisplay" tab“

5 Operating modes

5.1 Overview

Introduction

The stepper driver can be operated in a total of six different operating modes. Due to the great capacity and functions available, it offers designers and developers a rapid and simple method of resolving numerous drive requirements with less programming effort.

Select the required operating mode for your stepper motor application and configure the driver according to your requirements.

Overview of operating modes and their areas of application

Operating mode	Application
Positioning mode	<p>Use this mode when you wish to travel to a specific position.</p> <p>In the positioning mode, the motor travels according to a specified travel profile from a Position A to a Position B.</p> <p>Please refer to Section 5.3 „Positioning mode“.</p>
Speed mode	<p>Use this mode, when you wish to travel with a specific speed (e.g. a conveyor belt or pump speed).</p> <p>In the speed mode, the motor accelerates with a specified ramp from the starting speed (start frequency "V Start") to the specified maximum speed (maximum frequency "V Normal").</p> <p>Please refer to Section 5.4 „Speed mode“.</p>
Flag positioning mode	<p>The flag positioning mode offers a combination of the speed and positioning modes. The motor is initially operated in speed mode; hen a trigger point is reached, it changes to the positioning mode and the specified setpoint position (relative to the trigger position) is approached</p> <p>This operating mode is used, e.g. for labelling: the motor first travels with the set ramp to the synchronous speed of the conveyed goods. When the labels are detected, the preset distance (position) is travelled to apply the labels.</p> <p>Please refer to Section 5.5 „Flag positioning mode“.</p>
Clock direction mode	<p>Use this mode, when you wish to operate the driver with a superordinate controller (e.b. CNC controller)</p> <p>In the clock direction mode, the SMCI32 is operated via two inputs with a clock and a direction signal from a superordinate positioning control (indexer).</p> <p>Please refer to Section 5.6 „Clock direction mode“.</p>

Operating mode	Application
Analogue and Joystick mode	<p>The motor is controlled in this operating mode simply with a potentiometer or a joystick (–10 V to +10 V). Use this mode if you want to use the stepper motor in simple applications:</p> <ul style="list-style-type: none"> • Setting a specific speed e.b. via an external potentiometer, • Travelling synchronously with a superordinate controller with analogue output (–10 V to +10 V). <p>Please refer to Section 5.7 „Analogue and Joystick mode“.</p>
Analogue positioning mode	<p>Use this mode when you wish to travel to a specific position. The voltage at the analogue input directly controls the position. Please refer to Section 5.8 „Analogue positioning mode (Beta version)“.</p>

5.2 Entering profile parameters

Introduction

Up to 32 travel profiles can be defined and programmed in the various operating modes. The last 16 records (records 17 to 32) cannot be called up via the inputs, but only via the programming interface.

You can assign important profile parameters to a travel profile using the NANOPRO software. The parameters listed below do not all have to be specified in all modes.

When the mode is activated or changed, the relevant fields are displayed in the "Movement Mode" tab.

The "Movement Mode" tab

The profile parameters for a specific operating mode are set in the tab "Movement Mode".

Selection menu "Mode":

- The operating mode can be selected here.

Drive profile selection list:

- This window displays the maximum possible 32 travel profiles.
- In operating mode "Position", a maximum of 32 travel profiles are available.
- In operating mode "Speed", a maximum of 32 speed profiles are available.
- After selecting the required travel profile, the corresponding profile parameters are displayed in the parameter area.

Profile parameters:

- Displays parameters dependent on the selected operating mode and travel profile.
- Settings of required parameters for the various profiles (max. 32).

Motor parameters:

- Displays parameters of the stepper motor connected to the driver.
- Settings of parameters, see 7.2 „"Motor Settings" tab“.

Buttons for communication with the driver:



- <Test Record>
Pressing the button <Test Record> transfers the current record to the driver and starts it. The parameters are not saved by the driver.
- <Stop Record>
The currently operating record is stopped.
- <Save to Motor>
Pressing the button <Save to Motor> permanently stores the set travel profile in the driver.
Transfer can take a few seconds and is visually displayed with a progress bar.
The travel profiles can then be selected and started via the driver inputs.
- <Read from Motor>
All data stored in the driver is loaded onto your PC.

Profile graph display:

- Not available in all operating modes.
- Display only with relative positioning.
- The displayed profile graph can be used to rapidly see the ramp times (acceleration time) and the overall actuating time for the applicable travel profile.
- The graphic is recalculated after every relevant input.

Buttons for communication with the optional encoder:



- <Query State>
Pressing the button <Query state> queries the actual state of the driver and displays the state on screen.
- <Reset Counter>
Pressing the button <Reset counter> resets the current counter value to zero.
- <Read counter from Motor>
Pressing the button <Read counter from Motor> queries the actual counter value and displays it on screen.
- <Delivery Status>
Pressing the button <Delivery Status> resets all parameter settings in the driver to the default condition.

Procedure

The following is an example description of entering profile parameters for a travel profile in the operating mode "Position". Other parameters must be defined in other operating modes.

Proceed as follows:

Step	Action	Note
1	In the selection menu "Mode", select the required operating mode, e.g. "Position".	Only the relevant parameter fields are shown according to the selected operating mode.
2	Select the required travel profile, e.g. "01. Relative, 400,-".	The parameter values of the selected travel profile are displayed. The travel profile is defined by the positioning mode (option field "Operation Type") and the distances in the field "Position Demand".
3	In the selection menu "Operation Type", select the required operation mode: <ul style="list-style-type: none"> • "Relative" for relative positioning. • "Absolute" for absolute positioning. • "Reference Run Internal", when the travel profile is used to move to the internal reference point. • "Reference Run External", when the travel profile is used to move to the external reference point. 	<ul style="list-style-type: none"> • Relative positioning: The travel profile is started from the actual position. • Absolute positioning: The travel profile starts from a specified setpoint position, irrespective of the actual position.
4	In the field "Position Demand", enter the required distances for the selected travel profile.	The control variable can be input in steps, degrees or mm. The units can be changed in the "Generic" tab. Please refer to Section 7.3.
5	In the selection menu "Direction" (only for relative positioning), select the rotation direction of the travel profile.	You can choose between "Left" and "Right".
6	In the field "Minimal Speed", enter the required starting speed of the driver.	The minimal speed is the start-up speed (start-stop frequency) of the driver. To avoid step losses, this should be higher than the intrinsic resonance of the motor. However, too high a minimum speed can also lead to step losses. The speed can be input in Hertz, rpm or mm/s. The units can be changed in the "Generic" tab. Please refer to Section 7.3.
7	Enter the required normal speed of the driver in the field "Target Speed".	The normal speed is the travel speed of the driver. To avoid step losses, it should lie outside resonance ranges. Too high a maximum speed can cause step losses and motor stalling.

Step	Action	Note
8	In the field "Ramp", enter the ramp gradient. In some operating modes, you will see the set travel profile in the graphic (profile graphic) in the lower section of the main menu, providing you with an aid to setting the correct values.	Values are entered in Hz/ms. The steeper the ramp, the faster the acceleration. Eventual resonance ranges must be traversed as fast as possible. However, it is possible, if the acceleration is too high, that the motor skips and loses steps. In this case, the ramp must be reduced incrementally. The maximum value is 3000 Hz/ms (which is displayed as 2988.3 Hz/ms due to the underlying conversion table). The minimum value is 0.1 Hz/ms.
9	In the field "Break", enter the length of the break (motor idle time) after the end of the movement.	The unit is ms. To set a break of e.g. one second, the value 1000 must be entered.
10	In the field "Repetitions", enter how often the selected travel profile should be implemented automatically in sequence without another start command.	The entry "0" corresponds to constant operation. Minimum number of operations = 1. Maximum number of operations = 254
11	Activate the option field "Reverse Direction" (only for relative positioning), if you want an automatic change of direction.	When the change of direction is activated, the rotation direction of the motor is automatically changed when the same record (operation > 1) is called up several times in sequence or when the same travel profile is called up again at a later time. The direction is changed each time the same travel profile is called up again.
12	If necessary, select a travel profile in the selection menu "Next Record" that will be called up when the record is finished.	In order to use this function, the travel profile must first be saved with the button <Save to Motor>.
13	If you want to test the entered travel profile: Click on the button <Test Record>.	The stepper motor then travels according to the selected operating mode and travel profile.
14	If you want to permanently store the entered settings: Click on the button <Save to Motor>.	The data are then saved in the driver.

5.3 Positioning mode

5.3.1 Description

Function

In the positioning mode, the motor travels according to a specified travel profile from a Position A to a Position B.

The positions can be defined as absolute or relative values.

The positioning mode is preferentially used when travel to a specific position is required.

Travel profile

In this mode, up to 32 travel profiles (including reference runs) can be programmed and saved. The last 16 records (records 17 to 32) cannot be called up via the inputs, but only via the programming interface.

Entering a travel profile is described in Section 5.2 „Entering profile parameters“.

Parameter fields in the operating mode "Position"

Mode	Position	
Drive Profile		
01. Relative, 400, left, 1000, --	Operation Type	Relative
02. Relative, 400, left, 1000, --	Position Demand	400 Steps
03. Relative, 400, left, 1000, --	Direction	Left
04. Relative, 400, left, 1000, --	Minimal Speed	400 Hz
05. Relative, 400, left, 1000, --	Target Speed	1000 Hz
06. Relative, 400, left, 1000, --	Ramp	100.03 Hz/ms
07. Relative, 400, left, 1000, --	Break	1 ms
08. Relative, 400, left, 1000, --	Repetitions	1
09. Relative, 400, left, 1000, --	<input type="checkbox"/> Reverse Direction	
10. Relative, 400, left, 1000, --	Next Record	Number Type
11. Relative, 400, left, 1000, --	Ramp Type	Trapezoid Ramp
12. Relative, 400, left, 1000, --		
13. Relative, 400, left, 1000, --		
14. Relative, 400, left, 1000, --		
15. Relative, 400, left, 1000, --		
16. Relative, 400, left, 1000, --		
17. Relative, 400, left, 1000, --		
18. Relative, 400, left, 1000, --		
19. Relative, 400, left, 1000, --		
20. Relative, 400, left, 1000, --		
21. Relative, 400, left, 1000, --		

Reference runs

This mode also includes the internal and external reference runs (see Chapter 6 „Reference runs and limit switch behaviour“).

5.3.2 Input and output assignments

Input 1: Start input / Error reset

A signal at input 1 starts the selected travel profile. A negative edge at input 1 can be used to reset an error (speed monitoring).

Inputs 2 to 5: Selection of travel profile

The profile numbers are called up using a binary code with the Inputs 2 to 5. When input 1 is activated, the value is read in and the corresponding profile is loaded and started.

Profile number	Input 2	Input 3	Input 4	Input 5
1	0	0	0	0
2	1	0	0	0
3	0	1	0	0
4	1	1	0	0
5	0	0	1	0
6	1	0	1	0
7	0	1	1	0
8	1	1	1	0
9	0	0	0	1
10	1	0	0	1
11	0	1	0	1
12	1	1	0	1
13	0	0	1	1
14	1	0	1	1
15	0	1	1	1
16	1	1	1	1

Input 6: External limit switch

Please refer to Section 6.1 „External and internal reference runs and limit switch behaviour“.

Outputs

Output 1	Output 2	State
0	1	Driver processing last command.
1	0	"Ready" Motor idle, waiting for new command.
0	0	Error (speed monitoring) or limit switch (normal operation).
1	1	Reference point (zero position) reached.

5.3.3 Profile parameters

Parameter descriptions

The following parameters can be set in the positioning mode:

Parameters	Function
Drive profile	Up to a maximum of 32 travel profiles can be defined for a motor. The travel profile is defined by the positioning mode (selection menu: "Operation Type"), the distance in the field "Position Demand" and the rotation direction (+/-). E.g.: "01. Relative, 400, - "
Operation Type	<ul style="list-style-type: none"> • "Relative" for relative positioning: The travel profile is started from the actual position. • "Absolute" for absolute positioning: The travel profile starts from a specified setpoint position, irrespective of the actual position. • "Reference Run Internal", when the travel profile is used to move to the internal reference point. • "Reference Run External", when the travel profile is used to move to the external reference point.
Position Demand	<ul style="list-style-type: none"> • Absolute or relative position for the selected travel profile (distance). • The control variable can be input in steps, degrees or mm. • The units can be changed in the "Generic" tab.
Direction	Rotation direction of the travel profile (only with relative positioning): <ul style="list-style-type: none"> • Left • Right
Minimal Speed	"Start speed" (V Start): <ul style="list-style-type: none"> • Start-up speed (start/stop frequency) of the SMCI32 in Hz. • To avoid step losses, this should be higher than the intrinsic resonance of the motor. • Too high a minimum speed can also lead to step losses.
Target Speed	"Normal speed" (V Normal): <ul style="list-style-type: none"> • Normal travel speed in Hz of the SMCI32. • To avoid step losses, it should lie outside resonance ranges. • Too high a maximum speed can cause step losses and motor stalling.
Ramp	Ramp gradient: <ul style="list-style-type: none"> • Values are entered in Hz/ms. • The steeper the ramp, the faster the acceleration, however, if the acceleration is too high, the motor can skip and lose steps. • Eventual resonance ranges must be traversed as fast as possible. • The maximum value is 3000 Hz/ms. The set value is output as the next possible speed due to the coding in the motor (at 3000 Hz/ms e.g. as 2988.3 Hz/ms). • The minimum value is 0.1 Hz/ms.

Parameters	Function
Break	<ul style="list-style-type: none"> The break indicates the idle time of the motor when several runs must be implemented in sequence (only with relative positioning). The unit is ms. The minimum duration of the adjustable break is 1 ms.
Repetitions	The parameter "Repetitions" indicates how often the selected travel profile should be implemented automatically in sequence without another start command.
Reverse Direction	<ul style="list-style-type: none"> In the option field "Reverse Direction", the automatic change of direction can be activated (only with relative positioning). In active change of direction, the rotation direction of the motor is automatically changed when the same record is called up several times in sequence. The direction is changed after each call up.
Next Record	A travel profile can be defined in this selection menu to be called up when the current record is ended.
Ramp Type	The following ramp types can be selected: <ul style="list-style-type: none"> Trapezoid ramp Sinus ramp

Display of profile graph (only with relative positioning)

The displayed profile graph shows the ramp times (acceleration time) and the overall actuating time for the applicable travel profile.

The graphic is recalculated after every relevant input. This allows you to continually check and, where necessary, correct the settings made.

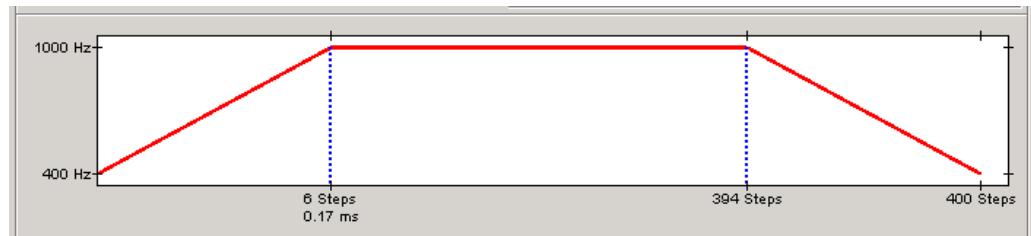

5.3.4 Signal curves in positioning mode

Example of a signal curve

In this example, profile number 5, then profile number 3, followed by profile number 16 (programmed as reference run) are started.

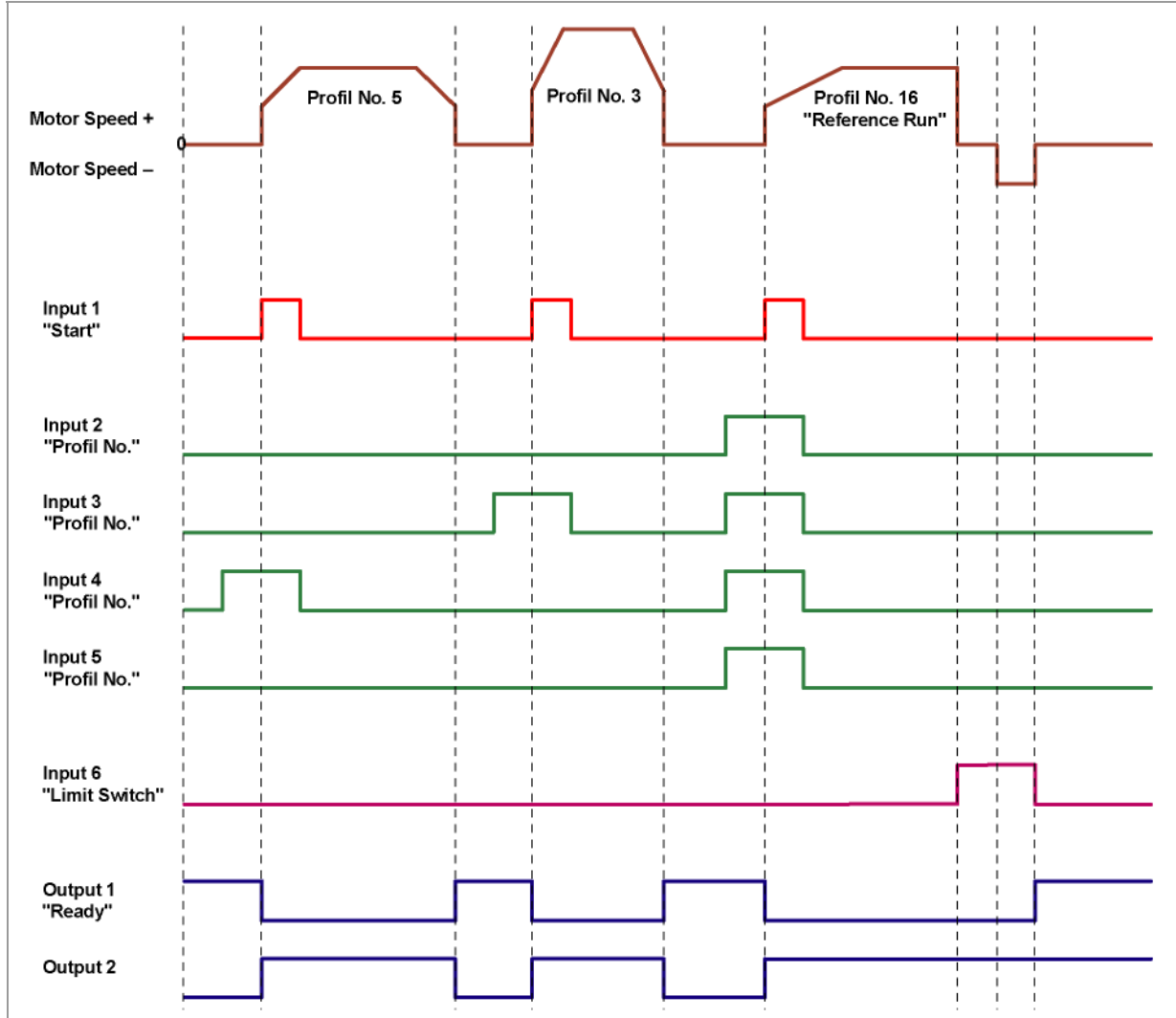

5.4 Speed mode

5.4.1 Description

Function

In the speed mode, the motor accelerates with a specified ramp from the starting speed (minimal speed/start frequency) to the specified maximum speed (target speed/maximum frequency).

The speed mode is generally used when a specific travel speed is required (e.g. for a conveyor belt or a pump).

Travel profile

In this mode, up to 32 travel profiles (speed profiles) can be programmed and saved. The last 16 records (records 17 to 32) cannot be called up via the inputs, but only via the programming interface. The direction is not saved in a travel profile. This is only possible via the corresponding input 6.

Parameter fields in the operating mode "Speed"

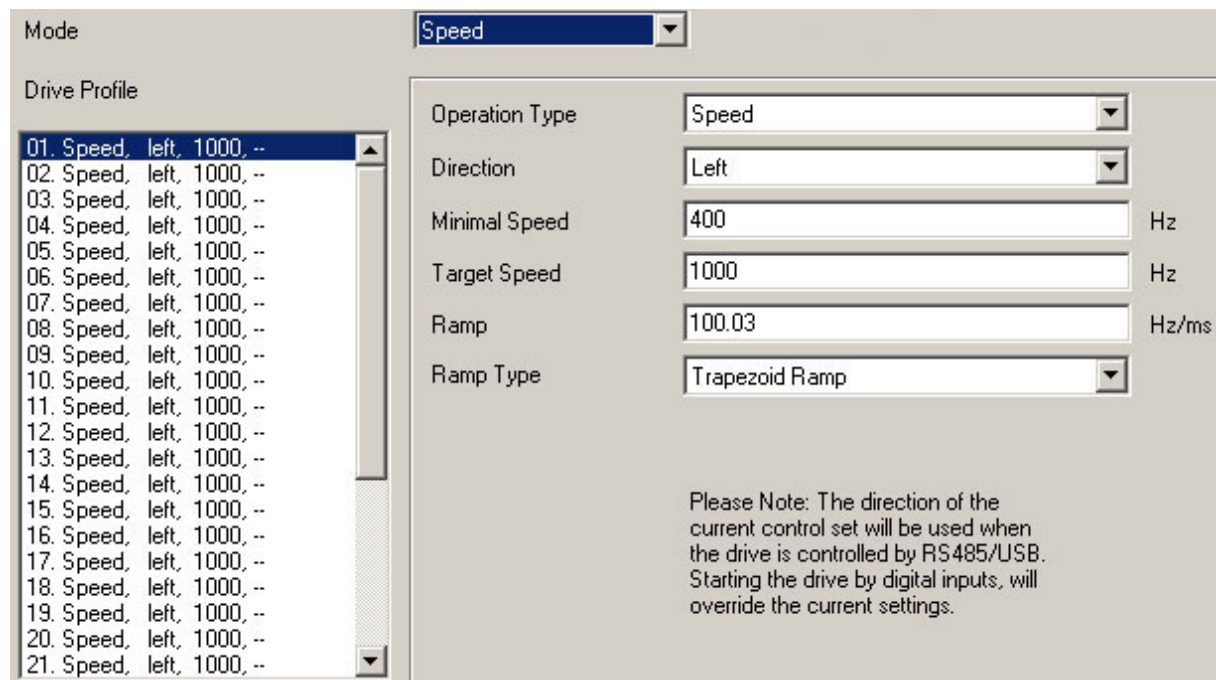

Mode: Speed

Drive Profile

- 01. Speed, left, 1000, --
- 02. Speed, left, 1000, --
- 03. Speed, left, 1000, --
- 04. Speed, left, 1000, --
- 05. Speed, left, 1000, --
- 06. Speed, left, 1000, --
- 07. Speed, left, 1000, --
- 08. Speed, left, 1000, --
- 09. Speed, left, 1000, --
- 10. Speed, left, 1000, --
- 11. Speed, left, 1000, --
- 12. Speed, left, 1000, --
- 13. Speed, left, 1000, --
- 14. Speed, left, 1000, --
- 15. Speed, left, 1000, --
- 16. Speed, left, 1000, --
- 17. Speed, left, 1000, --
- 18. Speed, left, 1000, --
- 19. Speed, left, 1000, --
- 20. Speed, left, 1000, --
- 21. Speed, left, 1000, --

Operation Type: Speed

Direction: Left

Minimal Speed: 400 Hz

Target Speed: 1000 Hz

Ramp: 100.03 Hz/ms

Ramp Type: Trapezoid Ramp

Please Note: The direction of the current control set will be used when the drive is controlled by RS485/USB. Starting the drive by digital inputs, will override the current settings.

Speed changes

Speed changes can be implemented at any time via the inputs or the interface.

If you start the motor for test purposes via the driver software NANOPRO (click on button <Test Record>), the following buttons change:

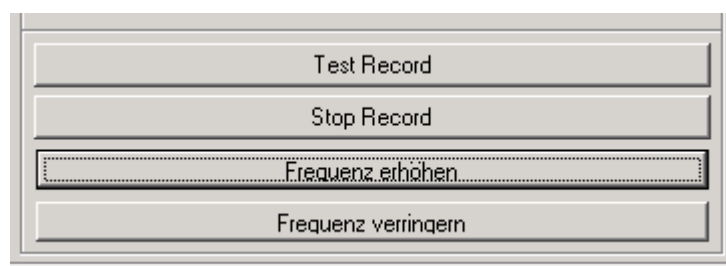

- The button <Save to Motor> changes to the button <Increase frequency>:
Clicking on the button increases the frequency (speed) of the motor by 100 Hz.
The actual frequency value is displayed in the field "Actual frequency".
- The button <Read from Motor> changes to the button <Decrease frequency>:
Clicking on the button decreases the frequency (speed) of the motor by 100 Hz.
The actual frequency value is displayed in the field "Actual frequency"

5.4.2 Input and output assignments

Input 1: Enable

Input 1 starts and stops the motor.

A negative edge at input 1 can be used to reset an error (speed monitoring).

Inputs 2 to 5: Speed

The speed is set with the inputs 2 to 5. The state of the inputs is continuously read and the corresponding speed parameter output. When the speed changes, the motor accelerates or brakes with the set ramp to the new setpoint speed. When the speed changes, the motor accelerates or brakes with the set ramp to the new setpoint speed.

Profile number	Input 2	Input 3	Input 4	Input 5
1	0	0	0	0
2	1	0	0	0
3	0	1	0	0
4	1	1	0	0
5	0	0	1	0
6	1	0	1	0
7	0	1	1	0
8	1	1	1	0
9	0	0	0	1
10	1	0	0	1
11	0	1	0	1
12	1	1	0	1
13	0	0	1	1
14	1	0	1	1
15	0	1	1	1
16	1	1	1	1

Input 6: Direction

Input 6 determines the rotation direction of the motor.

Outputs

Output 1	Output 2	State
0	1	Speed output running.
1	0	"Ready": Motor idle, waiting for new command.
0	0	Error (speed monitoring).
1	1	Zero position reached.

5.4.3 Profile parameters

Parameter descriptions

The following parameters can be set in the speed mode:

Parameters	Function
Operation Type	No selection option, only "Speed" possible.
Direction	Rotation direction of travel profile: <ul style="list-style-type: none"> • Left • Right <p>The rotation direction of the motor is only relevant when the motor is operated via the programming interface, otherwise the rotation direction is selected via an input.</p>
Minimal Speed	"Starting speed" <ul style="list-style-type: none"> • The minimum speed in Hz is the start-up speed (start-stop frequency) of the motor. • To avoid step losses, this should be higher than the intrinsic resonance of the motor. • Too high a minimum speed can also lead to step losses.
Target Speed	"Normal speed": <ul style="list-style-type: none"> • The maximum speed in Hz is the setpoint speed of the SMC132. • To avoid rough operation, it should lie outside resonance ranges. • Too high a maximum speed can cause step losses and motor stalling.
Ramp	Input of ramp gradient in Hz/ms.
Actual frequency	Display of actual speed with motor running.
Ramp Type	The following ramp types can be selected: <ul style="list-style-type: none"> • Trapezoid ramp • Sinus ramp

Profile graph display

The displayed profile graph shows the ramp times (acceleration time) and the setpoint speed for the applicable travel profile.

The graphic is recalculated after every relevant input. This allows you to continually check and, where necessary, correct the settings made.

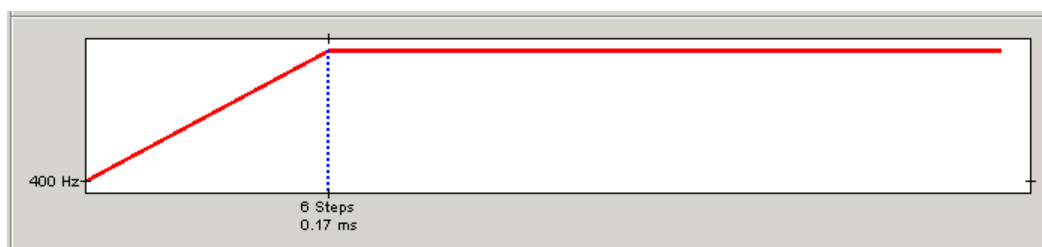

5.4.4 Signal curves in speed mode

Example of a signal curve

In this example, speed 4, speed 7 and then, after a change of direction, speed 13 are started.

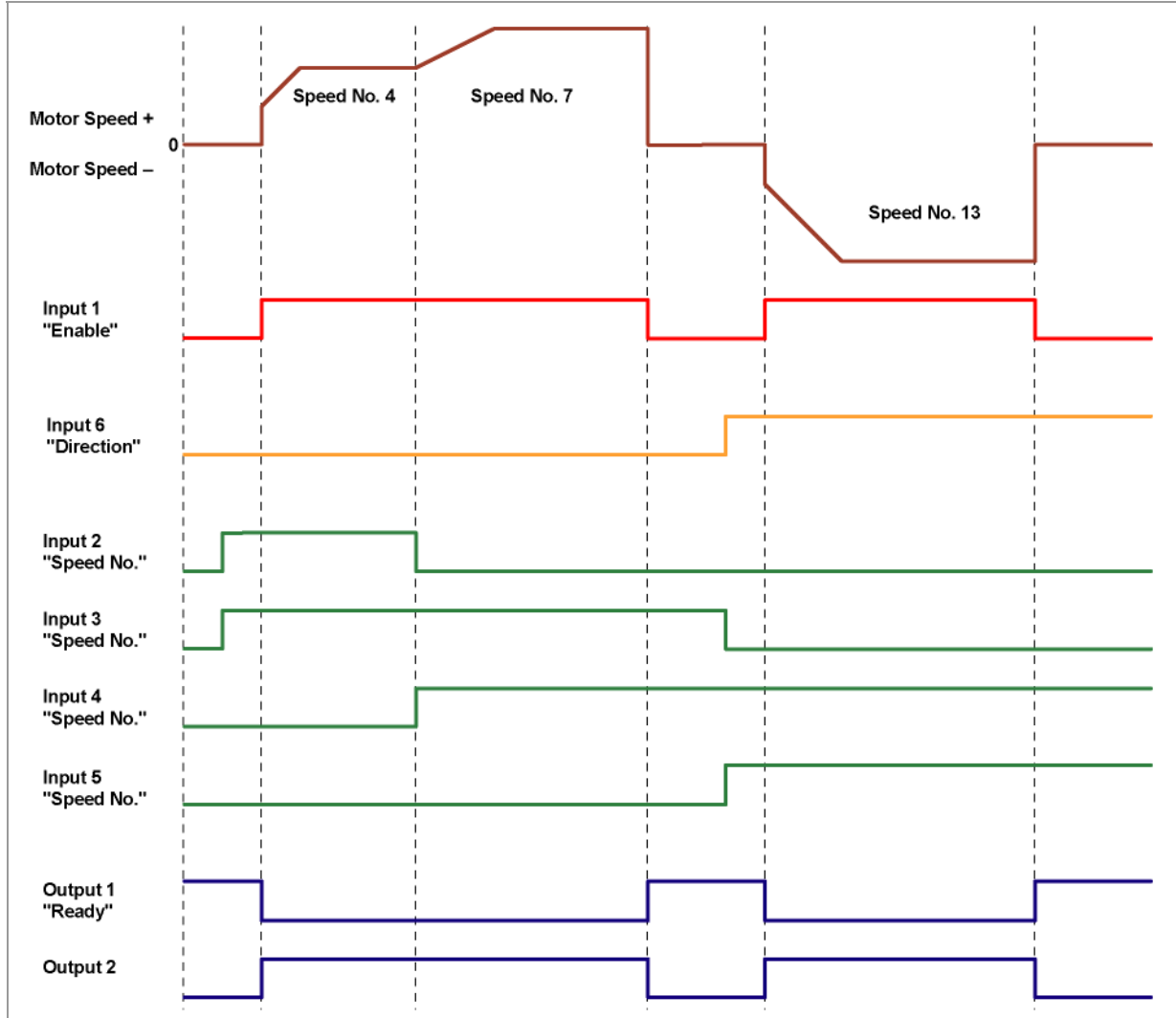

5.5 Flag positioning mode

5.5.1 Description

Function

The flag positioning mode offers a combination of the speed and positioning modes. The motor is first operated in speed mode to e.g. travel an undefined distance with a specific speed. When a trigger (trigger point) is reached, e.g. a limit switch, operation is switched to the positioning mode to travel to a defined setpoint position (relative to the trigger position).

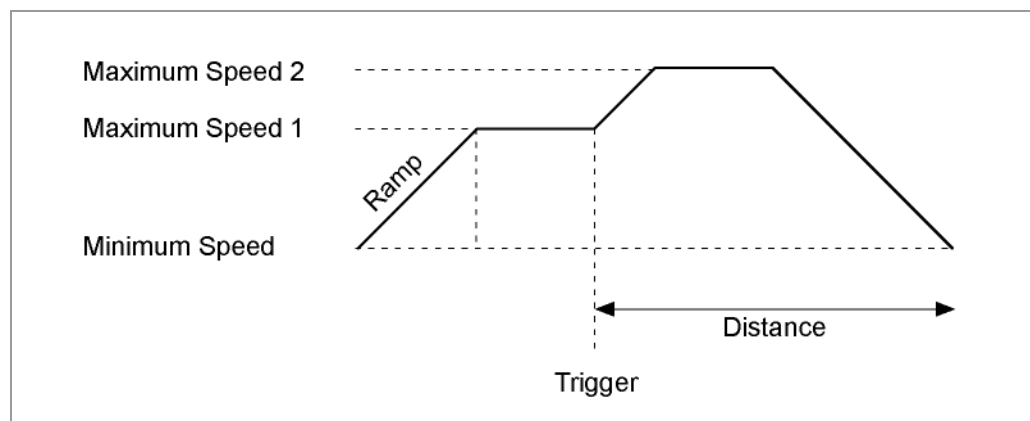

Travel profile

In this mode, up to 32 travel profiles (including reference runs) can be programmed and saved. The last 16 records (records 17 to 32) cannot be called up via the inputs, but only via the programming interface.

Parameter fields in the operating mode "Flag position"

Mode	Flag Position	
Drive Profile		
01. Flag Position, 400, left, 1000	Operation Type	Flag Position
02. Flag Position, 400, left, 1000	Position Demand	400 Steps
03. Flag Position, 400, left, 1000	Direction	Left
04. Flag Position, 400, left, 1000	Minimal Speed	400 Hz
05. Flag Position, 400, left, 1000	Target Speed	1000 Hz
06. Flag Position, 400, left, 1000	V Maximum	25001 Hz
07. Flag Position, 400, left, 1000	Ramp	100.03 Hz/ms
08. Flag Position, 400, left, 1000	Next Record	Number Type
09. Flag Position, 400, left, 1000		
10. Flag Position, 400, left, 1000		
11. Flag Position, 400, left, 1000		
12. Flag Position, 400, left, 1000		
13. Flag Position, 400, left, 1000		
14. Flag Position, 400, left, 1000		
15. Flag Position, 400, left, 1000		
16. Flag Position, 400, left, 1000		
17. Flag Position, 400, left, 1000		
18. Flag Position, 400, left, 1000		
19. Flag Position, 400, left, 1000		
20. Flag Position, 400, left, 1000		
21. Flag Position, 400, left, 1000		

Manually setting the trigger signal

The trigger signal can be set manually at input 5 via the NANOPRO driver software.

If you start the motor for test purposes (click on the button <Test Record>), the following button changes:

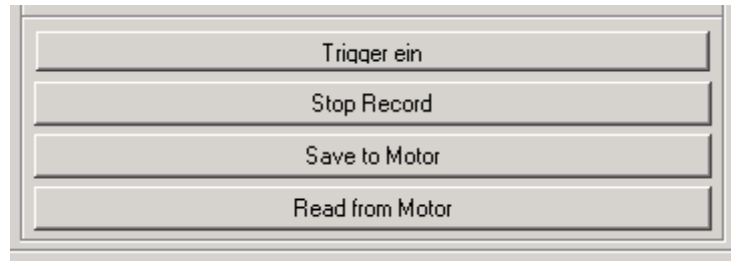

- The button <Test Record> changes to the button <Trigger on>:
By clicking on this button, the trigger signal is set and the motor changes from the speed mode to the positioning mode.

Reference runs

This mode also includes the internal and external reference runs (see Chapter 6 „Reference runs and limit switch behaviour“).

5.5.2 Input and output assignments

Input 1: Start

A signal at input 1 starts the speed mode.

A negative edge at input 1 can be used to reset an error (speed monitoring).

Inputs 2 to 4: Profile number

The profile number of the profile to be travelled is set with the inputs 2 to 4. When Input 1 is activated, the number is read in and the corresponding profile is loaded and started.

Profile number	Input 2	Input 3	Input 4
1	0	0	0
2	1	0	0
3	0	1	0
4	1	1	0
5	0	0	1
6	1	0	1
7	0	1	1
8	1	1	1

Input 5: Trigger

A signal at input 5 starts the positioning mode.

Input 6: External limit switch

Please refer to Section 6.1 „External and internal reference runs and limit switch behaviour“.

Outputs

Output 1	Output 2	State
0	1	Driver processing last command.
1	0	"Ready" Motor idle, waiting for new command.
0	0	Error (speed monitoring) or limit switch (normal operation).
1	1	Reference point reached.

5.5.3 Profile parameters

Parameter descriptions

The following parameters can be set in the flag positioning mode:

Parameters	Function
Operation Type	<ul style="list-style-type: none"> "Flag Position": The flag positioning mode is a combination of speed and positioning modes. "Reference Run Internal", when the travel profile is used to move to the internal reference point. "Reference Run External", when the travel profile is used to move to the external reference point.
Position Demand	<ul style="list-style-type: none"> Distance for the selected travel profile. The number of motor steps to be output can be selected up to 16,777,215 steps.
Direction	Rotation direction of travel profile: <ul style="list-style-type: none"> Left Right
Minimal Speed	"Starting speed" <ul style="list-style-type: none"> The minimum speed in Hz is the start-up speed (start-stop frequency) of the motor. To avoid step losses, this should be higher than the intrinsic resonance of the motor. Too high a minimum speed can also lead to step losses.
Target Speed	"Normal speed": <ul style="list-style-type: none"> The maximum "Speed 1" in Hz is the setpoint speed of the SMCI32. To avoid step losses, this should be higher than the intrinsic resonance of the motor. Too high a maximum speed can cause step losses and motor stalling.
V Maximum	<ul style="list-style-type: none"> Maximum "Speed 2" in Hz. Like maximum "Speed 1". Default set to 2000 Hz.
Ramp	Input of ramp gradient in Hz/ms.
Next Record	A travel profile can be defined in this selection menu to be called up when the current record is ended.

Profile graph display

The displayed profile graph shows the ramp times (acceleration time) and the overall actuating time for the applicable travel profile.

The graphic is recalculated after every relevant input. This allows you to continually check and, where necessary, correct the settings made.

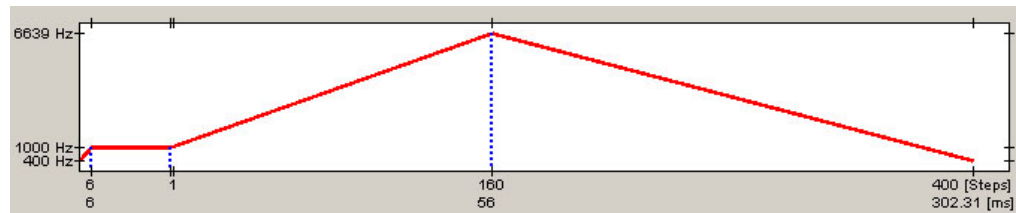

5.5.4 Signal curves in flag positioning mode

In this example, profile 4 is started and then a reference run (programmed as profile 8) is started.

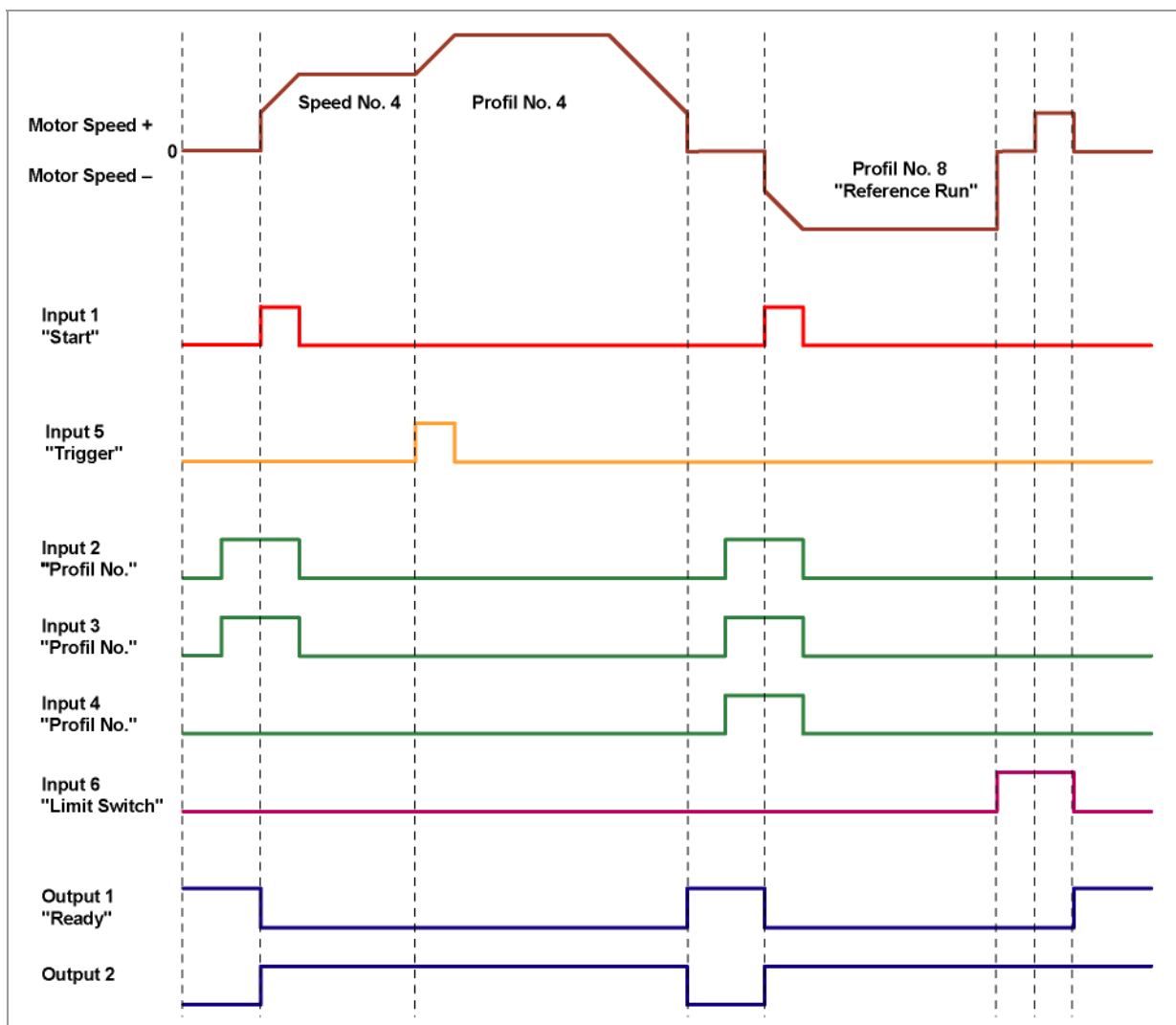

5.6 Clock direction mode

5.6.1 Description

Function

In the clock direction mode, the SMCI32 is operated via two inputs with a clock and a direction signal from a superordinate positioning control (indexer).

With every clock signal, the motor moves one step in the direction set by the direction signal.

Parameter fields in the operating mode "Clock direction"

Mode	Clock Direction		
Operation Type	Manual Left		
Minimal Speed	400		Hz
Target Speed	1000		Hz
Ramp	100.03		Hz/ms

Manual mode

The clock direction mode offers a manual mode which allows the motor to be operated manually for test purposes (rotation direction can be selected left or right).

After selecting the required direction in the field "Operation Type" (e.g. "Manual Left"), the motor can be started by clicking on the button <Test Record>.

Reference runs

This mode also includes the internal and external reference runs (see Chapter 6 „Reference runs and limit switch behaviour“).

5.6.2 Functions of the inputs and outputs

Input 1: Enable

The activation of Input 1, starts the manual mode selected in Inputs 2 and 3. The reference runs are also started by a signal at Input 1.

A negative edge at input 1 can be used to reset an error (speed monitoring).

Inputs 2 and 3: Manual mode

The manual mode is set with the Inputs 2 and 3. The settings are accepted when Input 1 is activated. The direction of the reference runs is also specified by the saved parameters. In manual modes 1 and 2 (left or right), the motor travels 10 steps with a frequency of ca. 2 Hz, then it accelerates to the programmed maximum frequency.

Mode selection

Number	Operation Type	Input 2	Input 3
1	Manual left	0	0
2	Manual right	1	0
3	Internal reference run	0	1
4	External reference run	1	1

Input 4: External limit switch

Please refer to Section 6.1 „External and internal reference runs and limit switch behaviour“.

Input 5: Direction

The direction input determines the rotation direction of the motor. A signal change at this input must be completed at least 150 µs before a clock signal.

Input 6: Clock (external)

With every positive edge at the clock input, the motor carries out a step in the direction set by the direction input.

Outputs

Output 1	Output 2	State
0	1	Driver processing last command.
1	0	Current reduction active.
0	0	Error (speed monitoring).
1	1	Reference point reached.

5.6.3 Profile parameters

Parameter descriptions

The following parameters can be set in the clock direction mode:

Parameters	Function
Operation Type	<ul style="list-style-type: none"> • "Manual Left": The motor is manually turned in the left direction. • "Manual Right": The motor is manually turned in the right direction. • "Reference Run Internal", when the travel profile is used to move to the internal reference point. • "Reference Run External", when the travel profile is used to move to the external reference point.
Minimal Speed	"Starting speed" <ul style="list-style-type: none"> • The minimum speed in Hz is the start-up speed (start-stop frequency) of the motor. • To avoid step losses, this should be higher than the intrinsic resonance of the motor. • Too high a minimum speed can also lead to step losses.

Parameters	Function
Target Speed	"Normal speed": <ul style="list-style-type: none"> • The maximum speed in Hz is the setpoint speed of the SMCI32. • To avoid step losses, this should be higher than the intrinsic resonance of the motor. • Too high a maximum speed can cause step losses and motor stalling.
Ramp	Input of ramp gradient in Hz/ms.

5.6.4 Signal curves in clock direction mode

In this example, the manual modes left and right are started after one another and then the external reference run is carried out.

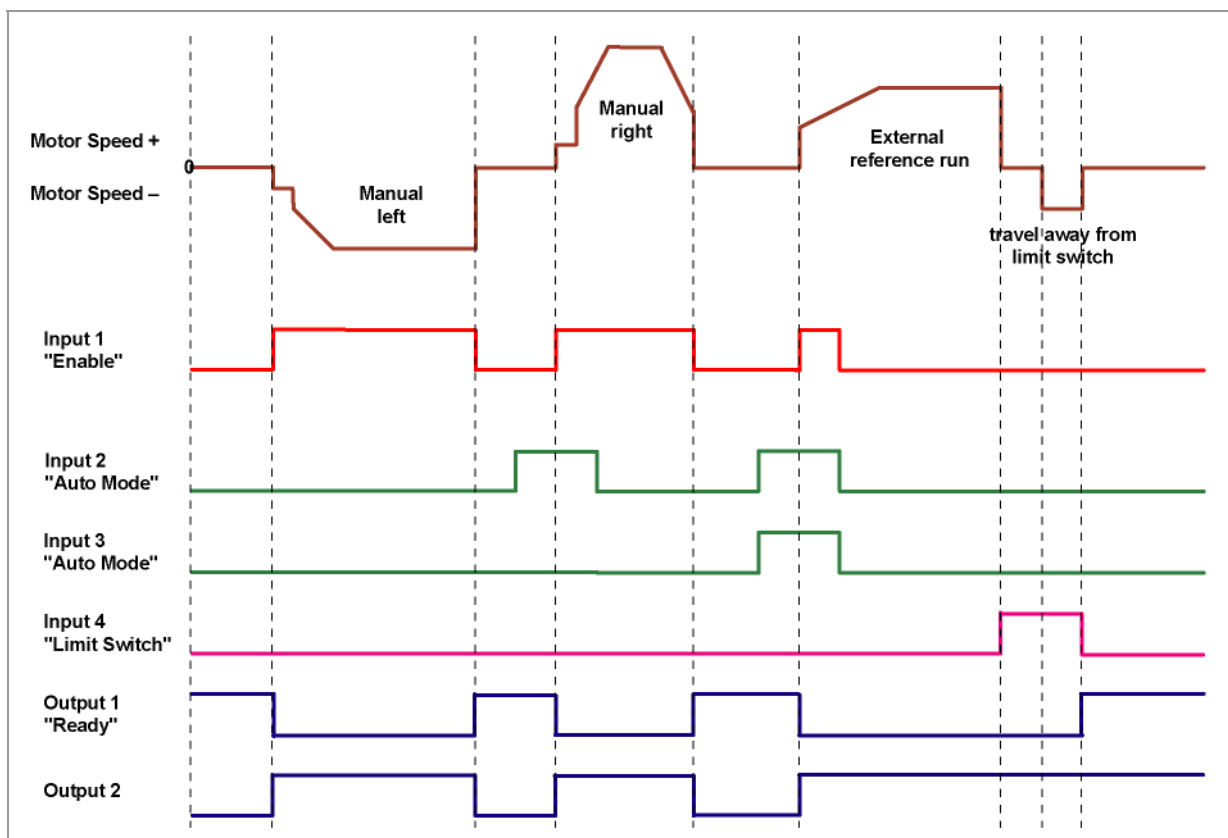

5.7 Analogue and Joystick mode

5.7.1 Description

Function

In the analogue or joystick mode, the stepper motor is operated in simple applications:

- with a specific speed, e.g. via an external potentiometer,
- or synchronously with a superordinate controller with analogue output (–10 V to +10 V).

The motor is simply actuated either by a potentiometer or an external power supply and a joystick (maximum –10 V to +10 V).

Note: The analogue and joystick modes differ only in a few points. Both modes are therefore described here in one section.

Parameter fields in the operating mode "Analogue"

Mode	Analogue		
Drive Profile	<ul style="list-style-type: none"> 01. Analogue, left, 1000, -- 02. Analogue, left, 1000, -- 03. Analogue, left, 1000, -- 04. Analogue, left, 1000, -- 05. Analogue, left, 1000, -- 06. Analogue, left, 1000, -- 07. Analogue, left, 1000, -- 08. Analogue, left, 1000, -- 09. Analogue, left, 1000, -- 		
Direction	Left		
Minimal Speed	400		Hz
Target Speed	1000		Hz
Ramp	100.03		Hz/ms

Parameter fields in the operating mode "Joystick"

Mode	Joystick		
Drive Profile	<ul style="list-style-type: none"> 01. Joystick 02. Joystick 03. Joystick 04. Joystick 05. Joystick 06. Joystick 07. Joystick 		
Minimal Speed	400		Hz
Target Speed	1000		Hz
Ramp	100.03		Hz/ms

5.7.2 Functions of the inputs and outputs

Input 1: Start

When input 1 is activated, the value is read in and the corresponding profile is loaded and started.

Inputs 2 to 5: Selection of travel profile

The profile number of the profile to be travelled is set with the inputs 2 to 5.

Profile number	Input 2	Input 3	Input 4	Input 5
1	0	0	0	0
2	1	0	0	0
3	0	1	0	0
4	1	1	0	0
5	0	0	1	0
6	1	0	1	0
7	0	1	1	0
8	1	1	1	0
9	0	0	0	1
10	1	0	0	1
11	0	1	0	1
12	1	1	0	1
13	0	0	1	1
14	1	0	1	1
15	0	1	1	1
16	1	1	1	1

Input 6: Direction

In analogue mode, the direction cannot be defined via the record as the digital inputs/outputs have a higher priority. The direction must however be defined via input 6.

In joystick mode, the direction of the motor is dependent on a defined voltage range. The direction is changed in the middle of the voltage range (e.g. at +5 V in a voltage range of 0 V to +10 V).

Please refer to Section 7.5 „I/O" tab (Beta version)“.

Analogue In

The analogue input "Analogue In" on Pin 11 (connector X1) can be actuated with max. -10 V to +10 V.

The motor operates at a speed proportional to the applied voltage. The voltage is resolved with an accuracy of 8 bits. The smaller the selected voltage range is, the worse the resolution of the speed will be.

Refer to the example in Section 7.5 „I/O" tab (Beta version)“.

5.7.3 Circuit

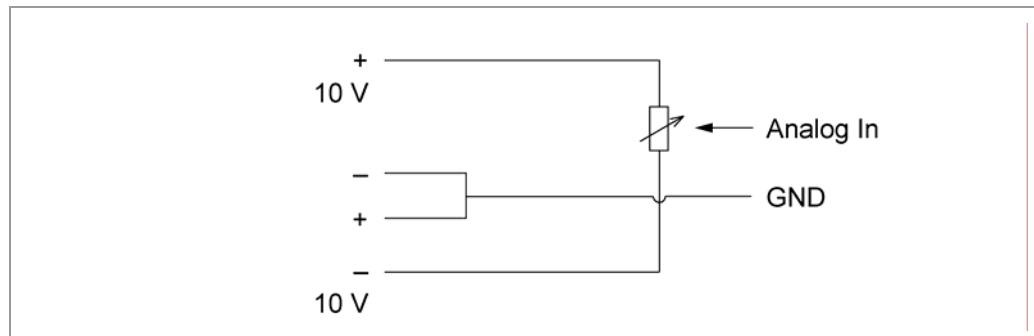

5.7.4 Profile parameters

Parameter descriptions

The following parameters can be set in the analogue or joystick mode:

Parameters	Function
Operation Type	<ul style="list-style-type: none"> "Analogue" The motor is operated in analogue mode. "Joystick" The motor is operated in joystick mode.
Direction	Rotation direction of the travel profile (only in analogue mode): <ul style="list-style-type: none"> Left Right <p>Note: In joystick mode, the voltage sign determines the rotation direction (– means "rotate left", + means "rotate right").</p>
Minimal Speed	"Starting speed" <ul style="list-style-type: none"> The minimum speed in Hz is the start-up speed (start-stop frequency) of the motor. To avoid step losses, this should be higher than the intrinsic resonance of the motor. Too high a minimum speed can also lead to step losses.
Target Speed	"Normal speed": <ul style="list-style-type: none"> The maximum speed in Hz is the setpoint speed of the SMC147. To avoid step losses, this should be higher than the intrinsic resonance of the motor. Too high a maximum speed can cause step losses and motor stalling.
Ramp	Input of ramp gradient in Hz/ms. In the analogue and joystick modes, the ramp determines the maximum acceleration. If the voltage changes too fast, e.g. by turning the potentiometer too rapidly, this ramp is used to accelerate to the maximum speed.

5.8 Analogue positioning mode (Beta version)

5.8.1 Description

Function

A specific position can be approached in this mode. The voltage at the analogue input directly controls the position.

Parameter fields

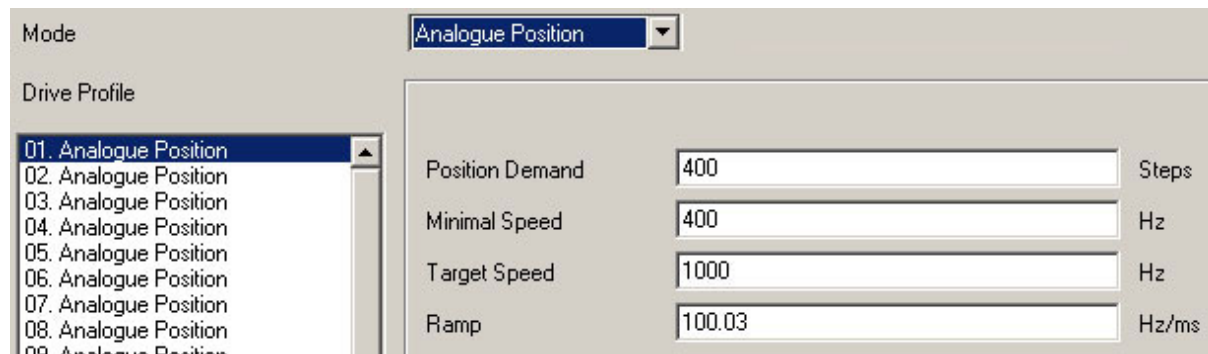

Mode: Analogue Position

Drive Profile:

- 01. Analogue Position
- 02. Analogue Position
- 03. Analogue Position
- 04. Analogue Position
- 05. Analogue Position
- 06. Analogue Position
- 07. Analogue Position
- 08. Analogue Position
- 09. Analogue Position

Position Demand: 400 Steps

Minimal Speed: 400 Hz

Target Speed: 1000 Hz

Ramp: 100.03 Hz/ms

5.8.2 Functions of the inputs and outputs

Input 1: Start

When input 1 is activated, the value is read in and the corresponding profile is loaded and started.

Inputs 2 to 5: Selection of travel profile

The profile number of the profile to be travelled is set with the inputs 2 to 5.

Profile number	Input 2	Input 3	Input 4	Input 5
1	0	0	0	0
2	1	0	0	0
3	0	1	0	0
4	1	1	0	0
5	0	0	1	0
6	1	0	1	0
7	0	1	1	0
8	1	1	1	0
9	0	0	0	1
10	1	0	0	1
11	0	1	0	1
12	1	1	0	1
13	0	0	1	1
14	1	0	1	1
15	0	1	1	1
16	1	1	1	1

Analogue In

The analogue input "Analogue In" on Pin 11 (connector X1) can be actuated with max. –10 V to +10 V. The voltage at the analogue input directly controls the position.

5.8.3 Profile parameters

Parameter descriptions

The following parameters can be set in the analogue positioning mode:

Parameters	Function
Position Demand	<ul style="list-style-type: none"> Distance for the selected travel profile. The number of motor steps to be output can be selected up to 16,777,215 steps.
Minimal Speed	"Starting speed" <ul style="list-style-type: none"> The minimum speed in Hz is the start-up speed (start-stop frequency) of the motor. To avoid step losses, this should be higher than the intrinsic resonance of the motor. Too high a minimum speed can also lead to step losses.
Target Speed	"Normal speed": <ul style="list-style-type: none"> The maximum speed in Hz is the setpoint speed of the SMC147. To avoid step losses, this should be higher than the intrinsic resonance of the motor. Too high a maximum speed can cause step losses and motor stalling.
Ramp	Input of ramp gradient in Hz/ms. In the analogue positioning mode, the ramp determines the maximum acceleration. If the voltage changes too fast, e.g. by turning the potentiometer too rapidly, this ramp is used to accelerate to the maximum speed.

5.8.4 Motor Settings

See Section 7.5 „I/O" tab (Beta version)“.

6 Reference runs and limit switch behaviour

6.1 External and internal reference runs and limit switch behaviour

Function description "External reference run"

During an external reference run, the motor travels to a switch connected to the reference input.

Note: The input varies according to the mode. See description of the input and output signals of the respective modes in Chapter 5 „Operating modes“.

After the start of the external reference run, the motor accelerates with the set ramp from the minimum to the maximum speed. When the reference switch is reached, movement is stopped for a break of 100 ms and then, according to the setting "Positioning behaviour at the limit switch", travel is recommenced away from the switch at the minimum speed (start/stop speed).

The reference switch can be an opener or a closer. This must be set with the software during programming.

Function description "Internal reference run"

During the internal reference run, the motor travels to an internal reference point at the set minimum speed. This reference point is on the motor shaft and is therefore reached with each full motor revolution.

As with external reference runs, the behaviour of the SMCI47 on recognising the reference point in normal operation (positioning and flag positioning modes) can be defined.

Positioning behaviour at the limit switch

The behaviour of the SMCI47 on recognising the reference switch can be defined separately for normal operation (positioning and flag positioning modes) and for reference runs.

There are four types of positioning behaviour at the limit switch:

- "Free backwards" (reference run and normal operation)
- "Free forwards" (reference run and normal operation)
- "Stop" (only for normal operation)
- "Disable" (only for normal operation)

These four types of positioning behaviour are described below.

Setting the limit switch behaviour

Please refer to Section 6.2 „Setting the limit switch behaviour“.

"Free backwards"

The motor changes direction on recognition of the limit switch and leaves the limit switch.

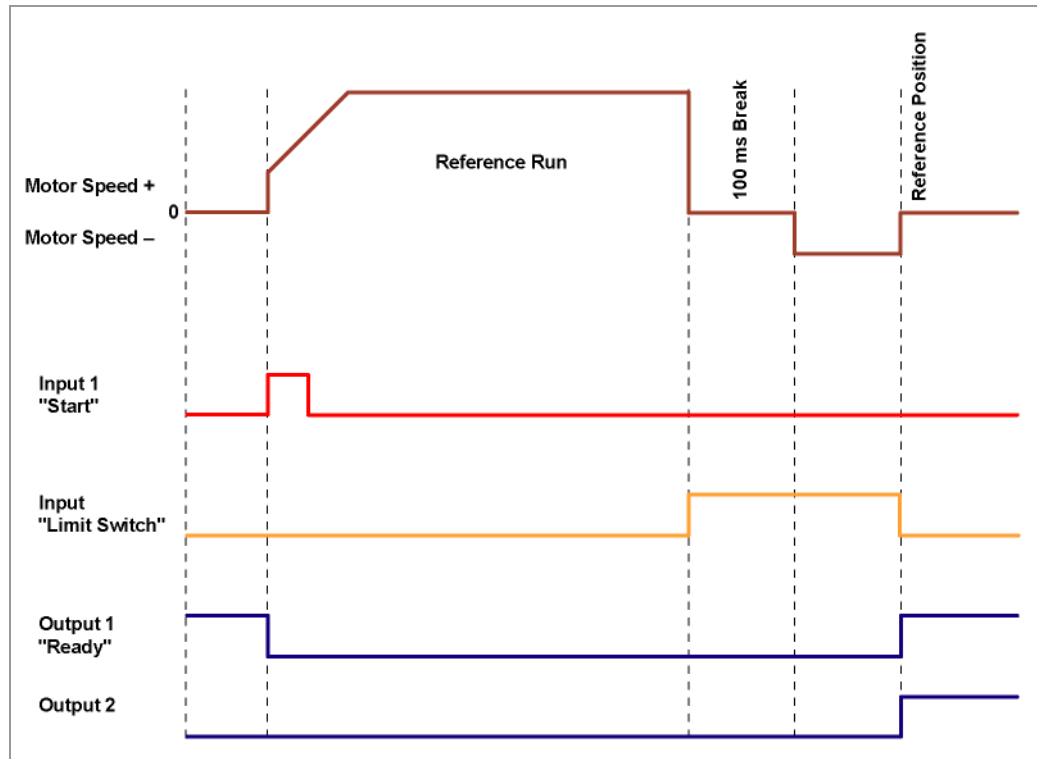

"Free forwards"

The motor continues in the same direction after recognising the limit switch and leaves the limit switch.

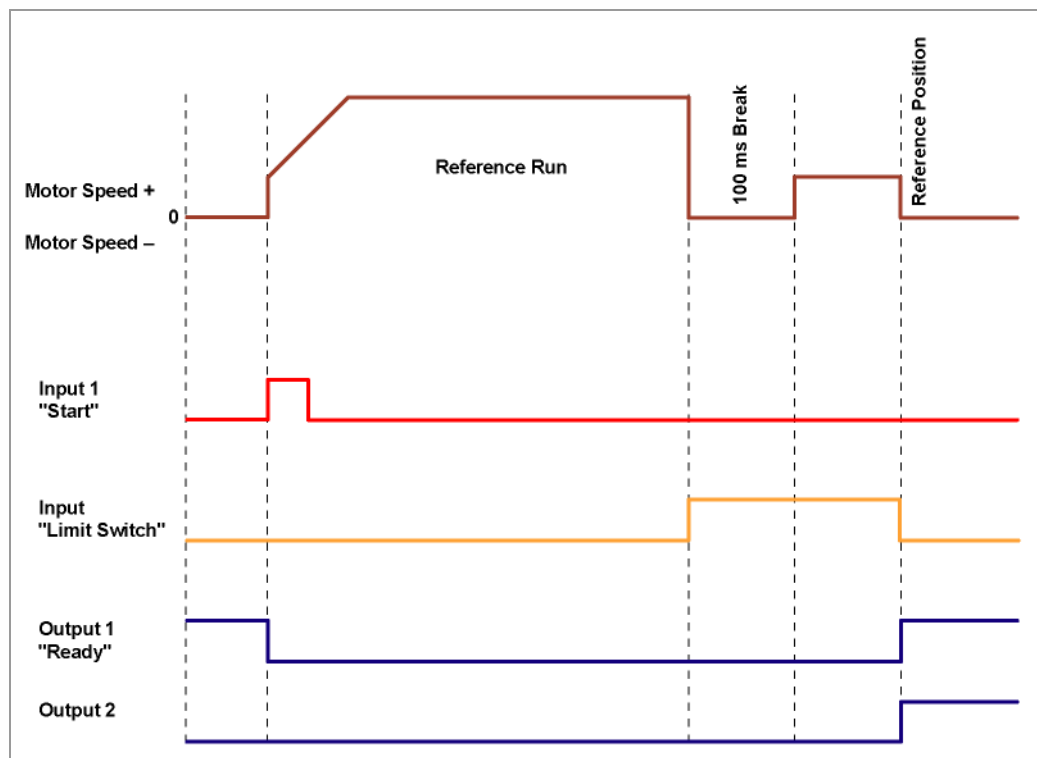

"Stop"

The motor stops immediately on recognition of the limit switch. A reference run must then be implemented as the motor may have lost steps (overflow).

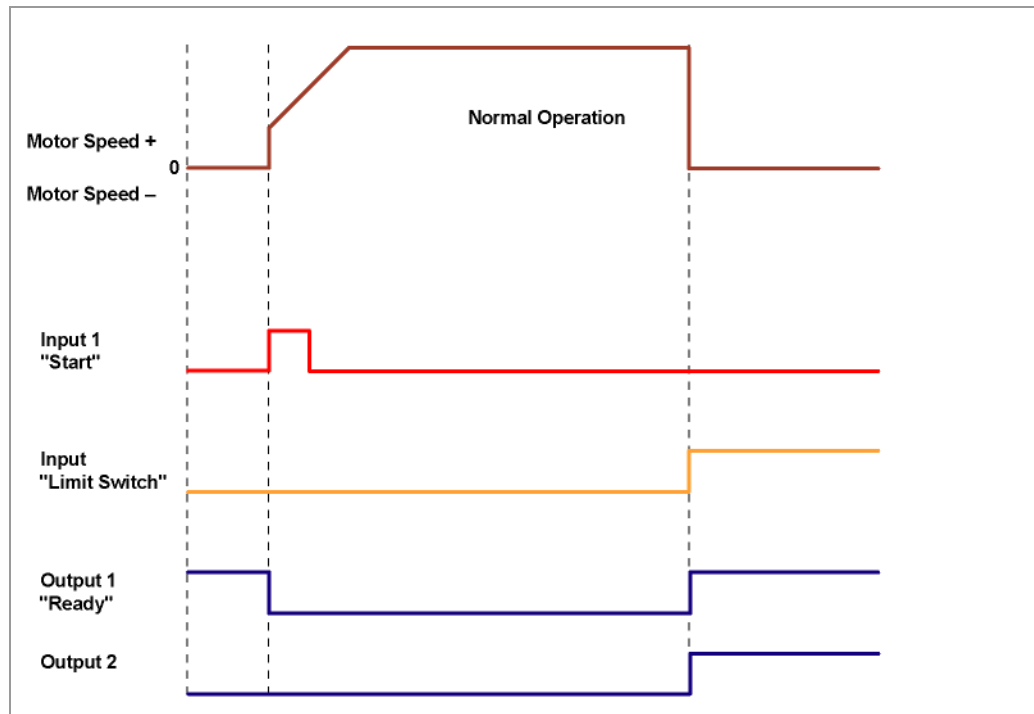

"Disable"

The limit switch has no function.

When a reference position is reached, outputs 1 and 2 are simultaneously switched on both in reference runs and in normal operation.

6.2 Setting the limit switch behaviour

General information

The SMCI47 stepper driver offers various possibilities of defining behaviour at the external and internal limit switches (see Section 6.1 „External and internal reference runs and limit switch behaviour“). The behaviour of the limit switch during reference runs and in normal operation can be defined in the “Generic” tab.

Behaviour during reference runs

Data on whether the limit switch (external and internal) should be approached during the reference run free forwards (without direction change) or backwards (in the opposite direction).

Behaviour during normal operation

Data on how the SMCI47 should behave when recognising the limit switch (external and internal) during normal operation (no reference run).

"Generic" tab

Procedure

Proceed as follows to set the limit switch behaviour:

Step	Action	Note
1	Select the "Generic" tab.	
2	Set the parameters according to your requirements.	
3	Click on the button <Save Data>.	The settings are saved.

7 Settings

7.1 Overview

User guidance

The transparent operating interface and simple test functions enable rapid entry into operation and programming of the SCMI47.

Due to the simple operating interface, not all functions are described in this manual. Many functions are self-explanatory. Only specific operating procedures are looked at in detail.

Familiarise yourself with the operating interface of the NANOPRO driver software before starting to commission and program the SMCI47 driver.

Setting options

In addition to the travel profile parameters which can be set in the "Mode" tab, you can implement further settings in the following tabs:

- "Motor Settings": General motor parameters.
- "Generic": Limit switch behaviour (internal/external) and display settings.
- "Errorcorrection": Settings for speed monitoring and error correction.
- "I/O": Settings for analogue mode and user-controlled inputs and outputs.
- "Communication": Settings for interface parameters and motor addresses.
- "Statusdisplay": Status display for the selected motor.

The tabs are described in the following sections.

7.2 "Motor Settings" tab

Display

The general motor parameters are set in the "Motor Settings" tab.

The screenshot shows the 'Motor Settings' tab with the following parameters:

- Step Mode: Half Step
- Drive Step Angle: 1.8°/step
- Phase Current: 10% (Current: 0.7, Peak Current: 0.90)
- Phase Current During Idleness: 10% (Current: 0.7, Peak Current: 0.90)
- Reverse clearance: 0 Steps
- Reverse Encoder Direction:
- Send State Byte Automatically Upon End of Record:
- Rotation Encoder Resolution: 500
- Motor Type: SMCI47 RS485
- External Brake:
 - Time ta: 0 ms
 - Time tb: 0 ms
 - Time tc: 0 ms

A 'Save Data' button is located at the bottom left of the settings panel.

Parameter descriptions

The following parameters can be set for the motor:

Parameters	Function	Note
Motor Type	Selection of motor type.	The user interface is modified to correspond to the selected motor type.
Step Mode	The following step modes can be selected: <ul style="list-style-type: none"> • Full step • Half step • Quarter step • Fifth step • Eighth step • Tenth step • 16th step • 32th step • 64th step • Adaptive microstep 	The smaller the selected step size is, the larger the resolution: E.g. with a 1.8° stepper motor, a half step is 0.9° and a tenth step is 0.18°. Adaptive microstep means that the step angle automatically increases with increasing speed. Example: at 30 rpm, the motor runs in 64th step mode and at 3000 rpm at full step as a higher speed is possible here and in general accuracy plays a subordinate role.
Drive Step Angle (step width full step)	Setting the step angle of the connected motor	In general, the motor is a 1.8° stepper motor (default). Another step angle can be selected if necessary in the selection menu.

Parameters	Function	Note
Phase current	The phase current can be set in steps of 1 %. The corresponding absolute value is automatically calculated and displayed in the display fields "Current" and "Peak Current".	The surge current is less in full step mode than in the other step modes. To achieve the same output as in full step mode, the motor needs higher surge currents in smaller step modes.
Phase Current During Idleness	Input of phase current at standstill in percent. The corresponding absolute value is automatically calculated and displayed in the display fields "Current" and "Peak Current". It is recommended to select the highest possible current reduction for standstill.	This current reduction serves to minimise the heat generated by the dissipation loss of the motor windings and the output stage of the driver. However, if the full holding torque is required during standstill, then the current reduction should not be activated or the phase current not reduced.
Reverse clearance	Input of steps to compensate for the reverse clearance of the mechanics, e.g. in linear axles or gears.	The steps entered here are added to every change of direction.
Reverse Encoder Direction	Option field for activating the encoder rotation direction change.	In some cases, an incorrect rotation direction is defined. This can be seen when the error message "Position error" is always displayed when testing records. Please refer also to Chapter 8.2 „Error messages“. This function can be used to change the A/B track in the software.
Send State Byte Automatically Upon End Of Record	If the option field is activated, status bytes are automatically sent at the end of a run.	The use of this option is sensible when just one motor is actuated and the end of the run must be evaluated. Note: This option must not be used when a network is set up as this could lead to conflicts and therefore to transmission errors.

7.3 "Generic" tab

Display

The settings are made in the "Generic" tab.

The screenshot shows the 'Generic' tab of the software interface. The 'Display Properties' section is highlighted, containing the following settings:

- Distance: Steps
- Speed: Hertz
- Position: Steps
- Feed Rate: 0 mm/rev
- Gear Reduction: :1

Other visible settings include:

- During Homing: Free backwards
- During Normal Operation: Disable
- Type: Closer
- During Homing: Free backwards
- During Normal Operation: Disable

Limit switch behaviour internal and external

The settings for the following parameters are described in the Section 6.2 "Setting the limit switch behaviour":

- Limit switch behaviour internal
- Limit switch behaviour external

Display settings

The following parameters can be set:

Parameters	Function	Note
Distance	The distance can be displayed in: <ul style="list-style-type: none"> • Steps • Degrees • mm 	The units of measure set here are inserted in the parameter fields of the various operating modes.
Speed	The speed can be displayed in: <ul style="list-style-type: none"> • Hz • Rpm • mm/s 	The units of measure set here are inserted in the parameter fields of the various operating modes.
Position	The counter reading can be displayed in: <ul style="list-style-type: none"> • Steps • Degrees • mm 	The units of measure set here are inserted in the parameter fields of the various operating modes.
Feed Rate	Definition of feed rate in mm/rev.	If one of the above parameters is set to "mm", then the corresponding feed must be entered in the field "Feed rate".
Gear Reduction	Option field for activating the field "Gear Reduction". Input of gear Reduction when field activated.	When the option field is set, the field "Gear reduction" is activated and the reduction value can be entered.

7.4 "Errorcorrection" tab

Display

The settings for speed monitoring and error correction are made in the "Errorcorrection" tab.

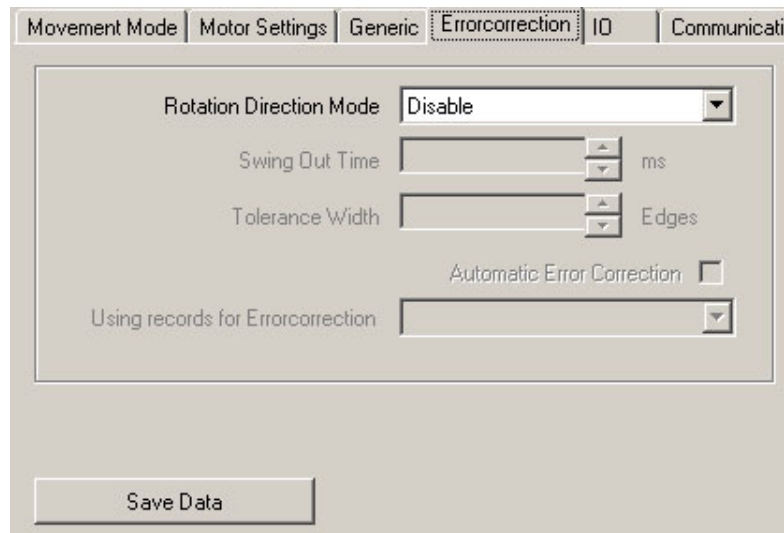

The screenshot shows the 'Errorcorrection' tab of a software interface. The tab is selected and highlighted. The interface includes the following elements:

- Rotation Direction Mode:** A dropdown menu set to 'Disable'.
- Swing Out Time:** A numeric input field with up and down arrows, followed by the unit 'ms'.
- Tolerance Width:** A numeric input field with up and down arrows, followed by the unit 'Edges'.
- Automatic Error Correction:** A checkbox that is currently unchecked.
- Using records for Errorcorrection:** A dropdown menu.
- Save Data:** A button located at the bottom of the tab.

Motor function test

The SMCI32 has an integrated encoder signal evaluation for checking motor functions and to signal step losses. If the motor loses more than 1 half step (0.9° with a 1.8° stepper motor), output 2 signals an error.

It is possible to compensate for this error at the end of or during the run.

Parameter descriptions

The following parameters can be set for the motor:

Parameters	Function	Note
Rotation Direction Mode	The following modes are available: <ul style="list-style-type: none"> • Disable • At end of run • During run 	"Disable" means that the speed monitoring is switched off. All fields in this section are therefore deactivated. The mode "Disable" must be selected when an encoder is not used. The rotation direction mode checks the position of the rotor at the end of the run (after the swing out time) or during the run. As described above, the position of the rotor can also be checked and corrected, if necessary, at the end of the run if the option field "Automatic Error Correction" is activated.
Swing Out Time	Definition of a swing out time in 1 ms steps, the time that the encoder waits before it measures the position of the rotor. The recommended standard value is 80 ms.	After a record is completed, the rotor swings out around the set target position before it comes to a standstill. This swing out is taken into account with the definition of a swing out time in order to avoid possible measurement errors. The swing out time decreases the smaller the moment of inertia of the rotor, and other external moments of inertia, is and the larger the damping, system rigidity and friction is.
Tolerance Width	Input of a tolerance within the encoder edges. The recommended standard value is 2 edges.	The tolerance is the maximum deviation in (micro)steps. How large a step is depends on the currently set step mode. If the encoder resolution is insufficient (step mode > 1/10 in 1.8° motors, or. >1/5 in 0.9° motors), additional errors will result from the conversion of encoder increments into microsteps.
Automatic Error Correction	Option field for activating automatic error correction	At the end of a record, the driver calculates the lost steps and compensates for them with a defined correction run. The parameters must be selected so that the driver safely implements the correction without losing any steps. When the setting is during the run, the correction will be implemented during the run itself.
Using records for Errorcorrection	Selection menu for definition of travel profile used for "Automatic Error Correction" (activated option field, see above).	The ramp and the speed in the selected travel profile are used for the correction run.

Starting within the swing out time

The specification of a swing out time before measurement of the rotor position by the encoder limits the possibility of rapid reversing movements.

In the positioning mode, a break between two reversing rotations must also be set (minimum = 1 ms). If the set break is shorter than the swing out time, the driver waits until the rotor is in a suitable position and then carries out the next record. This "suitable position" is determined when the tolerance width is set and avoids step losses.

The length of the break and swing out time (in ms) after the completion of a record is determined by the number of encoder edges. It is possible to realise rapid reversing movements with the specification of a tolerance width (in edges).

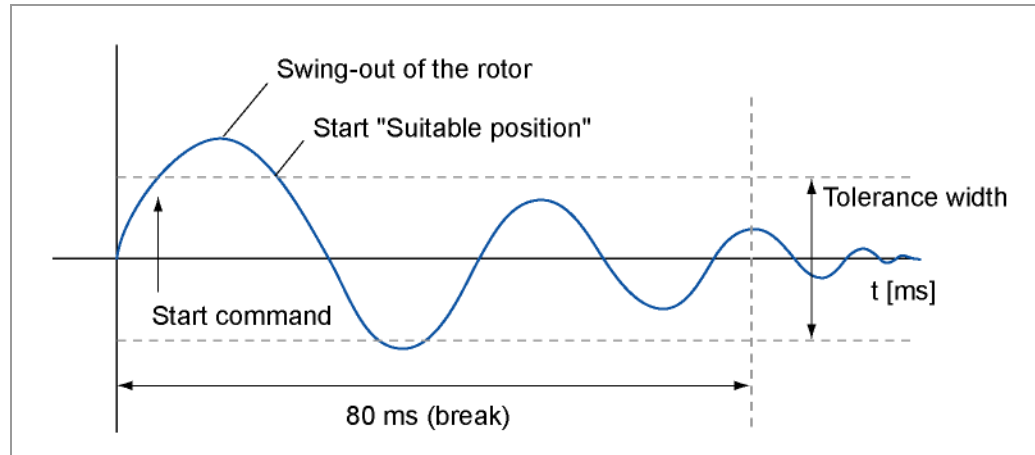

Encoder edges

An encoder has a 5 to 10 times higher resolution than the stepper motor. The encoders used operate with 500 pulses/revolution.

This squaring results in a resolution of 2,000 edges.

The 1.8° stepper motors operate with 200 steps/revolution, therefore a full step equals 10 encoder edges (half step = 5 edges).

The recommended tolerance width is 2 edges.

7.5 "I/O" tab (Beta version)

Display

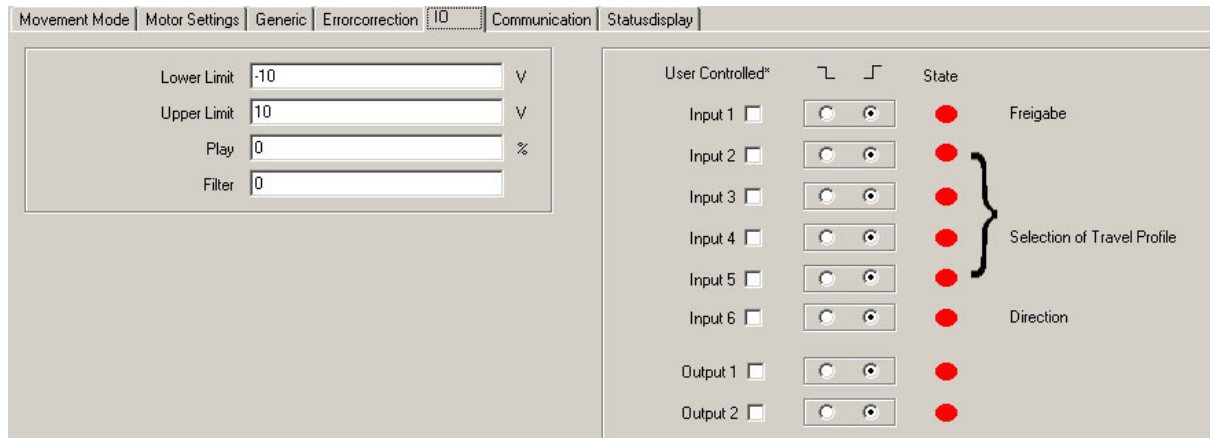

Parameters for analogue mode

The "I/O" tab has four parameters that define the analogue mode:

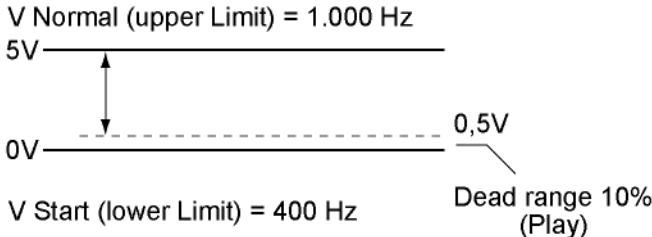

Parameters	Function
Lower Limit and Upper Limit	<p>These values determine the upper and lower limits of the input voltage.</p> <p>The voltage is resolved with an accuracy of 10 bits. The smaller the selected range is, the worse the resolution of the speed will be (and vice versa):</p> <ul style="list-style-type: none"> • Start speed: lower limit • Setpoint speed: upper limit • Maximum range: -10 V ... +10 V. <p>Calculation example</p> <p>Selected voltage range = 0 V to +5 V Start speed = 400 Hz = 0 V Setpoint speed = 1000 Hz = +5 V Speed adjustable:</p> <p>$8 \text{ bit} = 256 = 5 \text{ V} / 256 = 0.0195 \text{ V}$ corresponds to 9.375 Hz (400 Hz - 1000 Hz = 600 Hz / 64 = 9.375 Hz).</p> <p>The divisor "64" in the above equation is derived from the percentage of the voltage range used: The voltage range of 5 V out of a possible range of 20 V equals 25 %. Based on the 8 bit resolution, this is equal to 25 % of 256 = 64.</p>

Parameters	Function
<p>Play</p>	<p>The setting "Play" provides an option to hide the interference or ripple voltage in the lower limit range.</p> <p>A play of 10% would, with a lower limit of 0 V and an upper limit of 5 V, limit the control range to 0.5 – 5.0 V.</p>  <p>Calculation example for play: Selected voltage range = 0.5 V to +5 V Start speed = 400 Hz = 0.5 V Setpoint speed = 1000 Hz = +5 V Speed adjustable: 8 bit = 256 = 4.5 V / 256 = 0.0176 V corresponds to 10.417 Hz (400 Hz - 1000 Hz = 600 Hz / 57.6 = 10.417 Hz). Divisor from the percentage of the voltage range used: The voltage range of 4.5 V out of a possible range of 20 V equals 22.5 %. Based on the 8 bit resolution, this is equal to 22.5 % of 256 = 57.6.</p>
<p>Filter</p>	<p>The analogue input samples the input voltage with a frequency of 1 kHz. The input voltage can be smoothed with the help of the analogue input.</p> <p>A filter value between 0 and 16 results in a simple average value formation over the given number (a value of 0 or 1 indicated that averaging has not occurred).</p> <p>As filtering only takes 16 milliseconds with a sample frequency of 1 kHz over maximum 16 supporting points, it is possible to use a recursive filter where the determined value depends on the actually measured value and on the previous "filter value". This method can be used to average a greater number of supporting points, even if insufficient memory is available. However, this is not a real average value, but a signal rounding of the input voltage (first order low pass or PT1 element).</p> <p>The recursive filter is used from a value of 17. The time constant is doubled each time the value is increased. The longest time constant is reached with the value 31. The time constant can be read off from the following table.</p> <p>The time constant T indicates after how much time the filter output approaches 50% of the filter input. After a further time T has passed, the filter output then reaches 75% of the input.</p> <p>With an input jump from 0 to 1, the filter output follows the following rule: $Output = 1 - (0.5)^{t/T}$ where t is the time along the x axis and T the time constant of the filter.</p> <p>5*T after changing the input voltage, the value at the filter output has thus reached 97% of the input value.</p>

Parameters	Function																																																
	10*T after changing the input voltage, the value at the filter output will have reached 99.9% of the input value. The deviation corresponds to one stage of the AD converter when the input changes cover the entire range, e.g. a jump from -10 V to +10 V.																																																
	<table border="1"> <thead> <tr> <th>Value</th> <th>Time constant T</th> <th>Time for 99.9%</th> </tr> </thead> <tbody> <tr><td>17</td><td>1 ms</td><td>10 ms</td></tr> <tr><td>18</td><td>2 ms</td><td>20 ms</td></tr> <tr><td>19</td><td>4 ms</td><td>40 ms</td></tr> <tr><td>20</td><td>8 ms</td><td>80 ms</td></tr> <tr><td>21</td><td>16 ms</td><td>160 ms</td></tr> <tr><td>22</td><td>32 ms</td><td>320 ms</td></tr> <tr><td>23</td><td>64 ms</td><td>640 ms</td></tr> <tr><td>24</td><td>128 ms</td><td>1.2 s</td></tr> <tr><td>25</td><td>256 ms</td><td>2.6 s</td></tr> <tr><td>26</td><td>512 ms</td><td>5.1 s</td></tr> <tr><td>27</td><td>1 s</td><td>10 s</td></tr> <tr><td>28</td><td>2 s</td><td>20 s</td></tr> <tr><td>29</td><td>4 s</td><td>40 s</td></tr> <tr><td>30</td><td>8 s</td><td>80 s</td></tr> <tr><td>31</td><td>16 s</td><td>160 s</td></tr> </tbody> </table>	Value	Time constant T	Time for 99.9%	17	1 ms	10 ms	18	2 ms	20 ms	19	4 ms	40 ms	20	8 ms	80 ms	21	16 ms	160 ms	22	32 ms	320 ms	23	64 ms	640 ms	24	128 ms	1.2 s	25	256 ms	2.6 s	26	512 ms	5.1 s	27	1 s	10 s	28	2 s	20 s	29	4 s	40 s	30	8 s	80 s	31	16 s	160 s
Value	Time constant T	Time for 99.9%																																															
17	1 ms	10 ms																																															
18	2 ms	20 ms																																															
19	4 ms	40 ms																																															
20	8 ms	80 ms																																															
21	16 ms	160 ms																																															
22	32 ms	320 ms																																															
23	64 ms	640 ms																																															
24	128 ms	1.2 s																																															
25	256 ms	2.6 s																																															
26	512 ms	5.1 s																																															
27	1 s	10 s																																															
28	2 s	20 s																																															
29	4 s	40 s																																															
30	8 s	80 s																																															
31	16 s	160 s																																															

User-controlled inputs and outputs

The following settings can be made:

- Masking inputs and outputs:
When the check box is activated, the corresponding input or output is "masked", i.e. it is not directly interpreted by the driver and is therefore available to the user as a general purpose input or output.
The masked inputs are no longer available for record selection and are interpreted as 0.
The masking of an input means that its state (high / low) can be evaluated via the interface. Further information can be found in the relevant section of the document "Command reference". Further information can be found in the relevant section of the document "Command Reference".
- Switching behaviour:
A selection can be made for each input and output whether it switches with rising or falling edge:
 -  = falling edge
 -  = rising edge

State

In addition, the state of the inputs and outputs present when the tab was opened is displayed (green = high, red = low).

7.6 "Communication" tab

Display

The settings are made in the "Communication" tab.

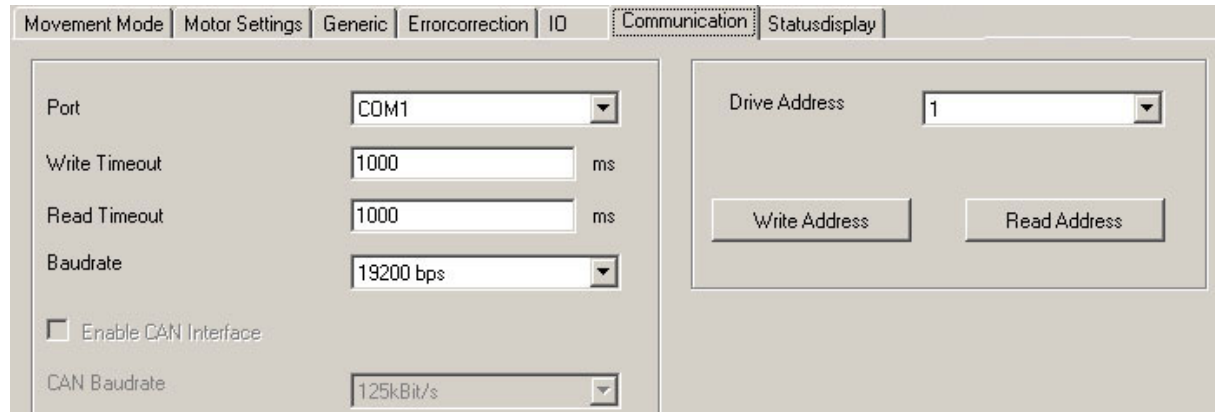

Interface parameters

The setting of the following interface parameters is described in Section 2.2 "Commissioning":

- Port
- Write/Read Timeout
- Baudrate

Setting the motor address

To set up an error-free connection with the SMCI47, the motor addresses (module addresses) must be set correctly. All SMCI47 are delivered with the default address "1". To operate several motors in an RS485 network, each motor must be assigned a unique address.

The following functions are available in this menu:

- Read actual motor address
Press the button <Read out> to read the actual address of the connected SMCI47. The actual module address is displayed in the "Drive Address" field.
- Assign new motor address
To assign a new address to the connected module, enter the appropriate address in the selection menu "Drive address" and then press the <Write Address> button. The address is then accepted by the module (motor).

Procedure

Proceed as follows to set the motor address:

Step	Action	Note
1	Select the "Communication" tab.	
2	Enter the required module address of the connected motor (selection menu).	Number 1 to 254.
3	Click on the button <Write Address>.	The settings are saved.

7.7 "Statusdisplay" tab

Introduction

The "Statusdisplay" tab can display general status messages, stored error entries and the status of the inputs and outputs for the selected motor.

"Statusdisplay" tab

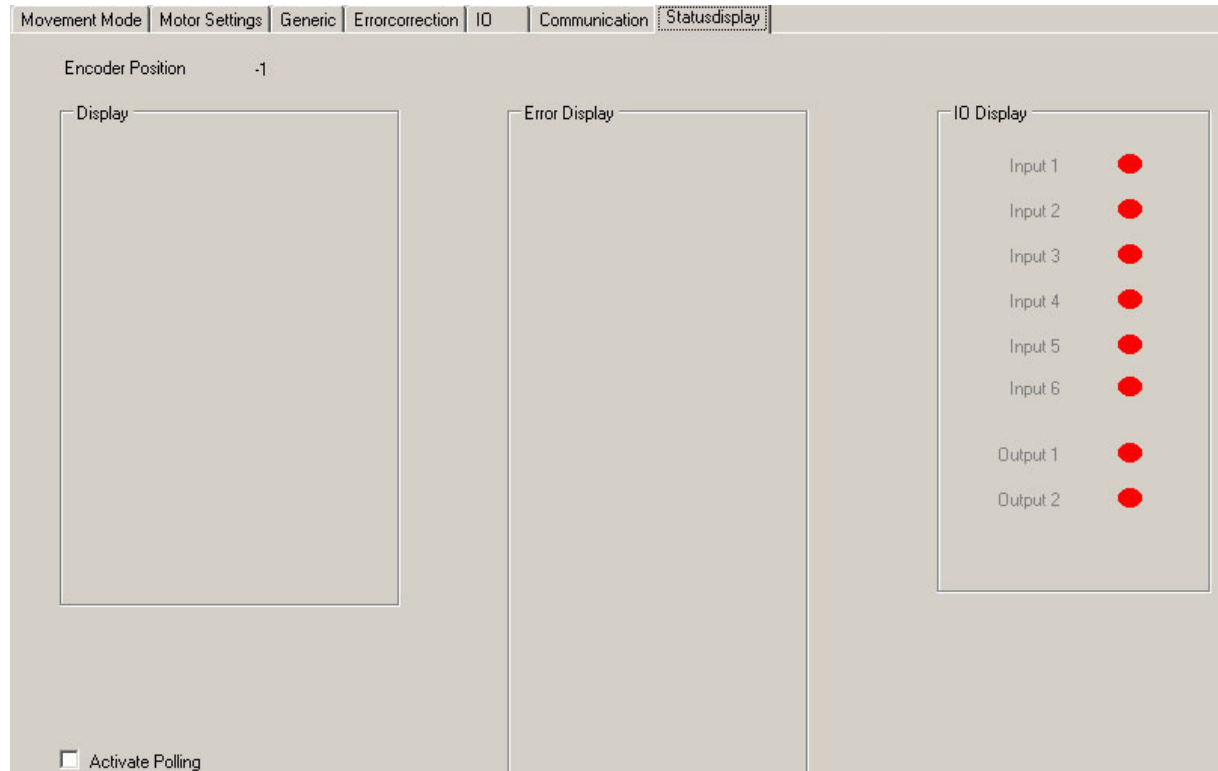

Displays

The "Statusdisplay" tab contains the following display:

Display	Function
Encoder Position	Actual encoder position (if an encoder is connected)
State	Actual mode, state and last error entry
Error Display	Error memory for the last 32 errors
I/O	Status of inputs and outputs (green = high, red = low)

Activate the status display

Proceed as follows to activate the motor status:

Step	Action	Note
1	Select the "Statusdisplay" tab.	
2	Activate the checkbox "Activate Polling".	

7.8 Operating several motors

Introduction

Up to 32 motors can be controlled in a network with an SMC132.

New motors can be added in the "Motor" menu by clicking on the <Add Motor> button.

All the motors entered in the driver are displayed in the selection menu.

Unnecessary motors can be removed from the driver by clicking on the <Remove Motor> button in the "Motor" menu.

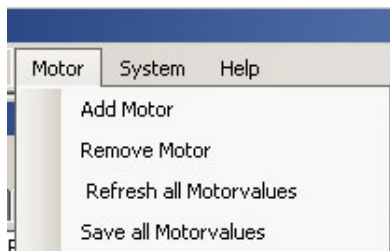

"Motor address" menu

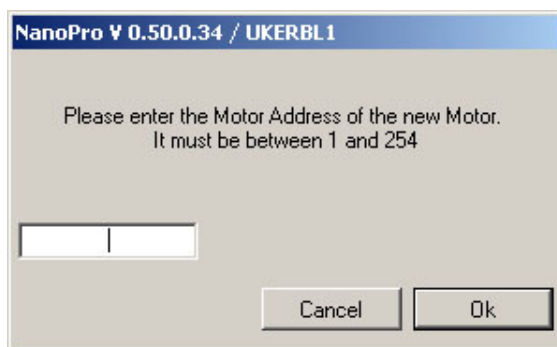

Procedure

Proceed as follows to add new motors:

Step	Action	Note
1	Select the menu item "Add Motor" in the "Motor" menu.	The menu "Motor address" opens.
2	Enter a motor address for the motor (number).	Number 1 to 254.
3	Click on the button <OK>.	The settings are saved.

8 Troubleshooting

8.1 General information

Error messages

The driver monitors specific functions and outputs an error message if there is a malfunction.

Error messages are displayed in a pop-up window, e.g.:

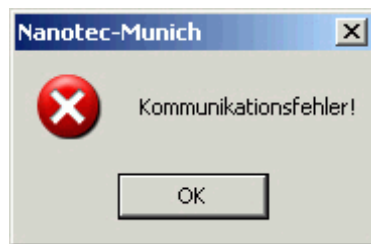

Descriptions of possible error messages can be found in Section 8.2 „Error messages“.

Troubleshooting procedure

Proceed with care during troubleshooting and error rectification to avoid damaging the driver.



Danger of electrical surges

An operating voltage > 50 V and incorrect connections can destroy the end stage.
Never disconnect the link when operating voltage is applied!
Never disconnect lines when live!

8.2 Error messages

Communication error

This message appears when data transmission to the SMCI47 is not possible:

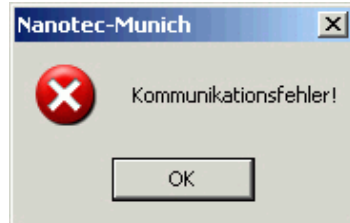

The following causes may be responsible:

- The wrong COM port is set (see Section 2.2 „Commissioning“).
- The communication cable is not connected or interrupted.
- A non-existent motor number is set.
- The power supply of the SMCI47 is interrupted.

Transmission error

This message appears when data transmission to the SMCI47 is disturbed (sender or receiver are disturbed):



The following causes may be responsible:

- Incorrect laying of the communication cable (motor and supply lines must be laid separately).
- The cable is not shielded.
- RS-485 wires are not twisted in pairs.
- The resistances for the resting level are not present in the communication line.
- The bus termination resistances are not present.

Driver is not ready

If inadmissible data is sent to the driver during the output of a travel profile, the following message appears:

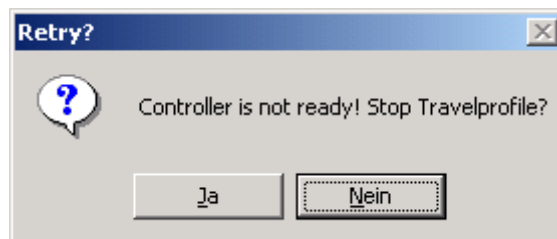

Pressing the <Yes> button stops the travel profile and the SMCI47 switches back to the "Ready" state. The data can then be resent to the driver.

Pressing the <No> button allows the travel profile to continue.

Driver is not active

If the driver is reset (switching the operating voltage off/on) during the output of a speed profile, the frequency can no longer be changed in the speed mode. The following message is displayed:



The speed mode can be restarted after pressing the <OK> button.

Position error

If a button is clicked while the driver is in error mode (position error or limit switch in normal operation), the following message is displayed.



The error can be reset by pressing the <Yes> button.

Input 1 active

If a button is clicked when a travel profile is already completed but input 1 is still active, the following error message will be displayed:

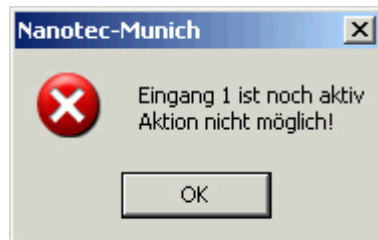

After the input is deactivated, the required button can be clicked.

8.3 Troubleshooting

Error	Possible cause	Rectification
Driver is not ready	Data transmission to SMCI47 not possible (communication error): Incorrect COM port selected.	In the "Communication" tab, select the PC port to which you have connected the SMCI47 (e.g. „COM-1“). The port used can be found in the device manager of your PC.
	Communication cable not connected or interrupted (incorrect RS232-RS485 converter used).	Function is not guaranteed with third-party 4-wire cables and 2-wire Nanotec converters do not function. Use the recommended RS232-RS485 converter from Nanotec: <ul style="list-style-type: none"> Order number: ZK-RS485-RS232
	A non-existent motor number (module number) is set.	Set the correct module address. See Section 7.6 „Communication" tab“.
	The power supply of the SMCI47 is interrupted.	Check voltage supply, switch on if necessary.
	Another open program is blocking the COM port to which the SMCI47 is connected.	Close down other programs on your PC.
	Inadmissible data was sent to the driver during the output of a travel profile.	Click on the <Yes> button to stop the travel profile. The SMCI47 switches back to the "Ready" state. The data can then be resent to the driver.
Transmission error	Data transmission to the SMCI47 is disturbed (sender or receiver are disturbed). Details see Section 8.2 "Error messages", Error message "Transmission error".	Check the possible causes for the transmission error and rectify the cause of the error.
Position error	A button was clicked while the driver was in error mode (position error or limit switch in normal operation).	Click the button <Yes> in the error message: the error is reset.
Red LED on the SMCI47 lit up.	Overtemperature of power electronics > 75 °C	Switch off driver and allow to cool. The error is reset when the SMCI47 is disconnected from the power supply unit.
	Undervoltage	Check voltage supply.

9 Technical data

9.1 Technical data

Electrical connections

Operating voltage U_b	DC 24 V to 48V \pm 4%
Max. phase current	Adjustable up to max. 12 A/Phase Continuous current 7.5 A/Phase
Current drop	Adjustable 0 to 80% of phase current
Interfaces	SMC147-2: <ul style="list-style-type: none"> • RS-485 (4 wire) <ul style="list-style-type: none"> - Dead time: 2 seconds - 19200 baud - 1 Start bit, 8 Data bits, 1 Stop bit - no parity • CAN bus

Driver parameters

Step resolution	Full step Half step Quarter step Fifth step Eighth step Tenth step 16th step 32th step 64th step Adaptive microstep (1/128)
Step angle	1.8°
Operating modes	Position Speed Flag position Clock direction Analogue Joystick
Step frequency	0 to 50 kHz in clock direction mode 0 to 25 kHz in all other modes
Position monitoring	Automatic error correction up to 0.9°

Inputs and outputs

Inputs	6 optocouplers +5 V Optional +24 V Signal delay time: Inputs 1 to 5: 120 µs Input 6: 10 µs
Outputs	3 transistor outputs Open-Collector +5 V to max. +30 V (≈ 30 mA) Signal delay time: Output 1/2: ≈ 12 µs (with 10 kΩ-Pull-Up at 24 V)

Protective circuits

Overvoltage and undervoltage	Protective circuit for voltages > 50 V or < 21 V
Max. heat sink temperature	Approx. 67 °C External ventilation may be required in full step operation, depending on the switch-on duration, current drop set and external cooling area.
Max. ambient temperature	0 to 40 °C

9.2 Dimensions and connectors

SMCI47 dimensions

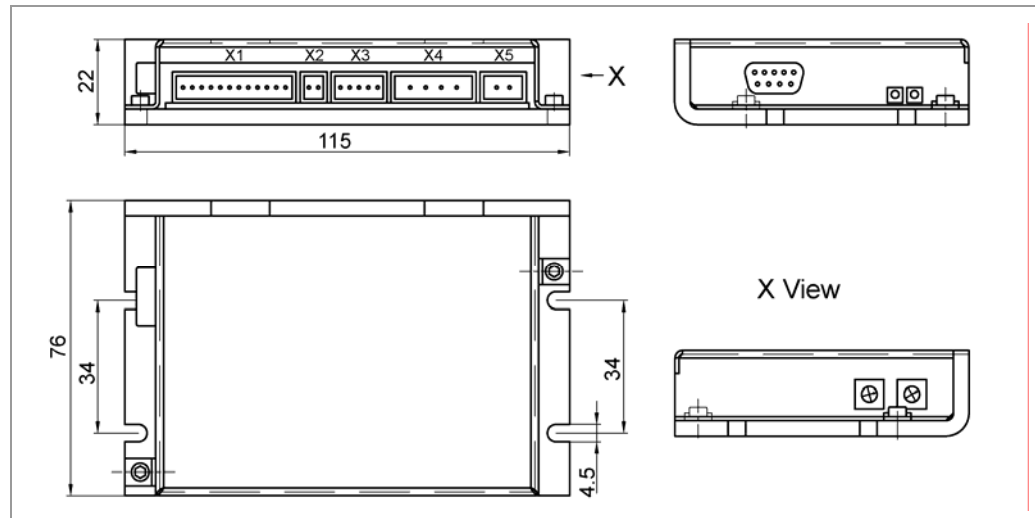

Connectors

The following connectors are available on the SMCI47:

- Connectors X1, X2:
Phoenix connector, Type MICRO COMBICON
- Connectors X3, X4:
Phoenix connector, Type COMBICON-HC
- Connector X5:
Sub-D 9-pin (RS485 or CAN)

Index

A

Accessories	19
Accessories for voltage supply	15
Activate the status display	65
Add new motor in driver	21
Analogue mode	45
inputs and outputs	46
motor parameters	61
parameter	47
profile parameters	47
Analogue positioning mode	48
inputs and outputs	48
parameters	49
Automatic error correction	59

B

Buttons	
communication with the driver	26
communication with the encoder	26

C

Clock direction mode	42
inputs and outputs	42
parameters	43
profile parameters	43
signal curves	44
Commissioning	
Provisions	8
Communication error	68
Connection diagram inputs and outputs (I/O)	10
Connection diagram SMCI47	7
Connection diagram stepper motor	13
Connection diagram voltage supply	15
Connector X1	10
Connector X2	12
Connector X3	13
Connector X4	15
Connector X5	16

Connectors	73
Correction run	59

D

Delete from driver	21
Download from the website	19

E

Encoder connection diagram	12
Encoder edges	60
Entering profile parameters	25
Entering travel profile	27
Error	
driver is not active	69
driver is not ready	68
input 1 active	69
Error Display	22, 65
Error messages	68
External reference run	50

F

Flag positioning mode	38
inputs and outputs	39
parameters	40
profile parameters	40
signal curves	41

I

Input circuits	11
Inputs and outputs	
analogue mode	46
analogue positioning mode	48
clock direction mode	42
flag positioning mode	39
joystick mode	46
positioning mode	30
speed mode	35
Installation from the website	19
Installing NANOPRO	19
Internal reference run	50

J		P	
Joystick mode.....	45	Parameters	
inputs and outputs.....	46	analogue mode.....	47
parameters.....	47	analogue positioning mode.....	49
profile parameters.....	47	clock direction mode.....	43
		flag positioning mode.....	40
L		joystick mode.....	47
Layout of operating interface.....	20	speed mode.....	36
Limit switch		Phase Current.....	56
behaviour during normal operation.....	53	Phase current during idleness.....	56
behaviour during reference runs.....	53	Pin assignment connector X2.....	12
Limit switch behaviour.....	50	Pin assignment connector X3.....	13
		Pin assignment connector X4.....	15
M		Pin assignment connector X5.....	16
Manually setting the trigger signal.....	39	Play.....	62
Menu		Polling.....	22, 65
File.....	20	Position error.....	69
Help.....	22	Positioning behaviour of the limit switch.....	50
Language.....	21	Positioning mode.....	29
Motor.....	21, 66	Inputs and outputs (I/O).....	30
System.....	21	profile parameters.....	31
Motor		signal curves.....	33
selection.....	21	Procedure.....	8
Motor function test.....	58	Profile parameters	
Motor parameters		analogue mode.....	47
analogue mode.....	61	analogue positioning mode.....	49
error correction.....	58	clock direction mode.....	43
speed monitoring.....	58	Entering profile parameters.....	25
Motor Settings.....	22, 25, 55	flag positioning mode.....	40
Motor status display.....	22, 65	joystick mode.....	47
		positioning mode.....	31
N		speed mode.....	36
NANOPRO		Protective circuits.....	72
menu bar.....	20		
menu window.....	22	R	
O		Reverse clearance.....	56
Online help.....	22	Reverse Encoder Direction.....	56
Operating modes.....	6	RS485 interface.....	16
Operating voltage.....	15		
Output circuits.....	11		

S	
Selection of travel profile	30
Setting	
display settings	57
machine parameters	57
Setting the limit switch behaviour	53
Signal curves	
clock direction mode	44
flag positioning mode	41
positioning mode	33
speed mode	37
SMCI47 dimensions	73
SMCI47 functions	5
Software filter	62
Speed changes	34
Speed mode	34
Inputs and outputs (I/O)	35
parameters	36
profile parameters	36
signal curves	37
Status Bytes	56
Status display	
motor	22, 65
Step mode	55
Swing out time	59
System requirements	19
T	
Tabs	22
Communication	64
Errorcorrection	58
Generic	53
I/O	61
Movement Mode	25
Statusdisplay	65
Technical data	71
Tolerance width	59
Transmission error	68
Troubleshooting	67, 70
Two-wire operation	18