

# Technical Manual NP5-08

Fieldbus: CANopen

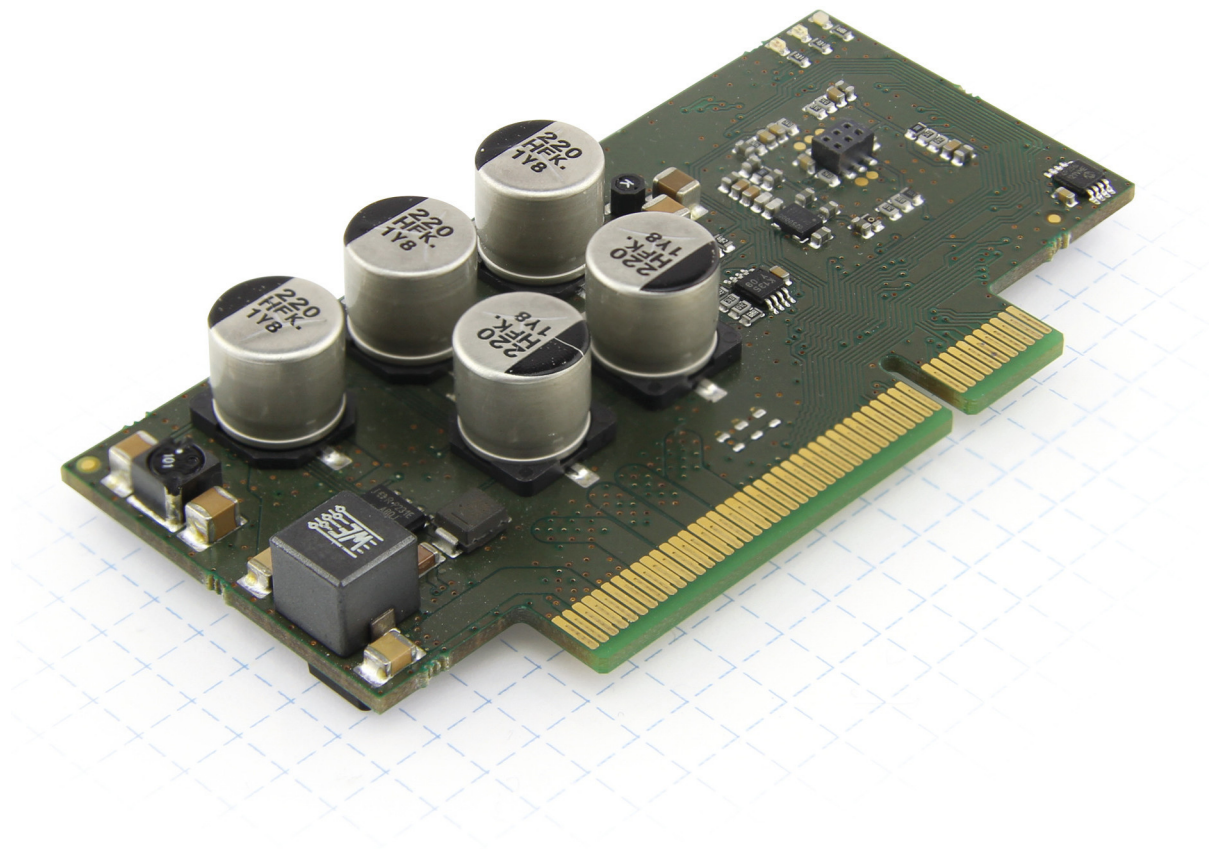

Valid with firmware version FIR-v2213  
and since hardware version W003b

Technical Manual Version: 2.3.0

# Contents

<b>1 Introduction.....</b>	<b>10</b>
1.1 Version information.....	10
1.2 Copyright, marking and contact.....	10
1.3 Intended use.....	11
1.4 Target group and qualification.....	11
1.5 Warranty and disclaimer.....	11
1.6 EU directives for product safety.....	12
1.7 Other applicable regulations.....	12
1.8 Used icons.....	12
1.9 Emphasis in the text.....	12
1.10 Numerical values.....	13
1.11 Bits.....	13
1.12 Counting direction (arrows).....	13
<b>2 Safety and warning notices.....</b>	<b>14</b>
<b>3 Technical details and pin assignment.....</b>	<b>15</b>
3.1 Environmental conditions.....	15
3.2 Dimensioned drawings.....	15
3.3 Electrical properties and technical data.....	16
3.4 Overtemperature protection.....	17
3.5 LED signaling.....	18
3.5.1 Power LED.....	18
3.6 Pin assignment.....	20
<b>4 Hardware installation.....</b>	<b>24</b>
4.1 Connecting the controller.....	24
4.1.1 Integrating the NP5.....	24
4.1.2 Connecting the CANopen.....	27
4.1.3 Connecting the NP5 controller via the <i>Discovery Board</i> .....	29
<b>5 Commissioning.....</b>	<b>35</b>
5.1 Communication settings.....	35
5.1.1 CANopen.....	35
5.2 Establishing communication.....	37
5.2.1.....	37
5.3 Setting the motor data.....	38
5.4 Connecting the motor.....	38
5.5 Auto setup.....	39
5.5.1 Parameter determination.....	39
5.5.2 Execution.....	40
5.5.3 Parameter memory.....	41
5.6 Configuring the sensors.....	41
5.7 Test run.....	43
<b>6 General concepts.....</b>	<b>44</b>
6.1 Control modes.....	44

- 6.1.1 General..... 44
- 6.1.2 Open-Loop..... 45
- 6.1.3 Closed-Loop..... 47
- 6.1.4 Slow Speed..... 53
- 6.2 CiA 402 Power State Machine..... 55
  - 6.2.1 State machine..... 55
  - 6.2.2 Behavior upon exiting the *Operation enabled state*..... 57
- 6.3 User-defined units..... 60
  - 6.3.1 Units..... 61
  - 6.3.2 Encoder resolution..... 62
  - 6.3.3 Gear ratio..... 62
  - 6.3.4 Feed constant..... 63
  - 6.3.5 Calculation formulas for user units..... 63
- 6.4 Limitation of the range of motion..... 65
  - 6.4.1 Behavior upon reaching the limit switch..... 65
  - 6.4.2 Software limit switches..... 66
- 6.5 Cycle times..... 66

## **7 Operating modes.....67**

- 7.1 Profile Position..... 67
  - 7.1.1 Overview..... 67
  - 7.1.2 Setting travel commands..... 68
  - 7.1.3 Loss of accuracy for relative movements..... 72
  - 7.1.4 Boundary conditions for a positioning move..... 73
  - 7.1.5 Jerk-limited mode and non-jerk-limited mode..... 74
- 7.2 Velocity..... 75
  - 7.2.1 Description..... 75
  - 7.2.2 Activation..... 75
  - 7.2.3 Controlword..... 75
  - 7.2.4 Statusword..... 75
  - 7.2.5 Object entries..... 75
- 7.3 Profile Velocity..... 76
  - 7.3.1 Description..... 76
  - 7.3.2 Activation..... 76
  - 7.3.3 Controlword..... 76
  - 7.3.4 Statusword..... 76
  - 7.3.5 Object entries..... 77
- 7.4 Profile Torque..... 79
  - 7.4.1 Description..... 79
  - 7.4.2 Activation..... 79
  - 7.4.3 Controlword..... 79
  - 7.4.4 Statusword..... 79
  - 7.4.5 Object entries..... 80
- 7.5 Homing..... 81
  - 7.5.1 Overview..... 81
  - 7.5.2 Homing method..... 83
- 7.6 Interpolated Position Mode..... 88
  - 7.6.1 Overview..... 88
  - 7.6.2 Activation..... 88
  - 7.6.3 Controlword..... 88
  - 7.6.4 Statusword..... 88
  - 7.6.5 Use..... 88
  - 7.6.6 Setup..... 89
  - 7.6.7 Operation..... 89
- 7.7 Cyclic Synchronous Position..... 89
  - 7.7.1 Overview..... 89
  - 7.7.2 Object entries..... 90
- 7.8 Cyclic Synchronous Velocity..... 91

7.8.1 Overview.....	91
7.8.2 Object entries.....	91
7.9 Cyclic Synchronous Torque.....	92
7.9.1 Overview.....	92
7.9.2 Object entries.....	93
7.10 Clock-direction mode.....	93
7.10.1 Description.....	93
7.10.2 Activation.....	93
7.10.3 General.....	93
7.10.4 Statusword.....	94
7.10.5 Subtypes of the clock-direction mode.....	94
7.11 Auto setup.....	95
7.11.1 Description.....	95
7.11.2 Activation.....	95
7.11.3 Controlword.....	95
7.11.4 Statusword.....	95
<b>8 Special functions.....</b>	<b>96</b>
8.1 Digital inputs and outputs.....	96
8.1.1 Defining input and output assignments.....	96
8.1.2 Bit assignment.....	97
8.1.3 Digital inputs.....	97
8.1.4 Digital outputs.....	101
8.2 Automatic brake control.....	106
8.2.1 Description.....	106
8.2.2 Activation and connection.....	106
8.2.3 Brake control.....	106
8.2.4 Brake PWM.....	107
8.3 External ballast circuit.....	108
8.3.1 Control of the ballast resistor.....	108
8.3.2 Activating the ballast.....	109
8.3.3 Ballast monitoring.....	109
8.3.4 Example of a ballast circuit.....	110
8.4 I <sup>2</sup> t Motor overload protection.....	111
8.4.1 Description.....	111
8.4.2 Object entries.....	111
8.4.3 Activation.....	111
8.4.4 Function of I <sup>2</sup> t.....	111
8.5 Saving objects.....	112
8.5.1 General.....	112
8.5.2 Category: communication.....	113
8.5.3 Category: application.....	113
8.5.4 Category: customer.....	115
8.5.5 Category: drive.....	115
8.5.6 Category: tuning.....	116
8.5.7 Category: CANopen.....	116
8.5.8 Starting the save process.....	116
8.5.9 Discarding the saved data.....	117
8.5.10 Verifying the configuration.....	117
<b>9 CANopen.....</b>	<b>119</b>
9.1 General.....	119
9.1.1 CAN message.....	119
9.2 CANopen services.....	119
9.2.1 Network Management (NMT).....	120
9.2.2 Synchronization object (SYNC).....	121
9.2.3 Emergency Object (EMCY).....	122

9.2.4 Service Data Object (SDO).....	123
9.2.5 Process Data Object (PDO).....	129
9.2.6 Boot-Up Protocol.....	134
9.2.7 Heartbeat and Nodeguarding.....	135
9.3 LSS protocol.....	136
9.3.1 General.....	136
9.3.2 LSS message.....	136
9.3.3 LSS services.....	137
9.3.4 Example.....	148
<b>10 Programming with NanoJ.....</b>	<b>149</b>
10.1 NanoJ program.....	149
10.2 Mapping in the NanoJ program.....	153
10.3 NanoJ functions in the NanoJ program.....	154
10.4 Restrictions and possible problems.....	156
<b>11 Description of the object dictionary.....</b>	<b>158</b>
11.1 Overview.....	158
11.2 Structure of the object description.....	158
11.3 Object description.....	158
11.4 Value description.....	159
11.5 Description.....	160
1000h Device Type.....	161
1001h Error Register.....	162
1003h Pre-defined Error Field.....	163
1005h COB-ID Sync.....	167
1006h Communication Cycle Period.....	168
1007h Synchronous Window Length.....	168
1008h Manufacturer Device Name.....	169
1009h Manufacturer Hardware Version.....	169
100Ah Manufacturer Software Version.....	169
100Ch Guard Time.....	170
100Dh Live Time Factor.....	170
1010h Store Parameters.....	171
1011h Restore Default Parameters.....	174
1014h COB-ID EMCY.....	178
1016h Consumer Heartbeat Time.....	178
1017h Producer Heartbeat Time.....	180
1018h Identity Object.....	180
1019h Synchronous Counter Overflow Value.....	182
1020h Verify Configuration.....	182
1029h Error Behavior.....	183
1400h Receive PDO 1 Communication Parameter.....	185
1401h Receive PDO 2 Communication Parameter.....	186
1402h Receive PDO 3 Communication Parameter.....	187
1403h Receive PDO 4 Communication Parameter.....	188
1404h Receive PDO 5 Communication Parameter.....	189
1405h Receive PDO 6 Communication Parameter.....	190
1406h Receive PDO 7 Communication Parameter.....	191
1407h Receive PDO 8 Communication Parameter.....	192
1600h Receive PDO 1 Mapping Parameter.....	194
1601h Receive PDO 2 Mapping Parameter.....	196
1602h Receive PDO 3 Mapping Parameter.....	199
1603h Receive PDO 4 Mapping Parameter.....	201
1604h Receive PDO 5 Mapping Parameter.....	203
1605h Receive PDO 6 Mapping Parameter.....	205
1606h Receive PDO 7 Mapping Parameter.....	207

1607h Receive PDO 8 Mapping Parameter.....	209
1800h Transmit PDO 1 Communication Parameter.....	211
1801h Transmit PDO 2 Communication Parameter.....	214
1802h Transmit PDO 3 Communication Parameter.....	216
1803h Transmit PDO 4 Communication Parameter.....	218
1804h Transmit PDO 5 Communication Parameter.....	220
1805h Transmit PDO 6 Communication Parameter.....	222
1806h Transmit PDO 7 Communication Parameter.....	224
1807h Transmit PDO 8 Communication Parameter.....	226
1A00h Transmit PDO 1 Mapping Parameter.....	228
1A01h Transmit PDO 2 Mapping Parameter.....	231
1A02h Transmit PDO 3 Mapping Parameter.....	233
1A03h Transmit PDO 4 Mapping Parameter.....	236
1A04h Transmit PDO 5 Mapping Parameter.....	238
1A05h Transmit PDO 6 Mapping Parameter.....	241
1A06h Transmit PDO 7 Mapping Parameter.....	243
1A07h Transmit PDO 8 Mapping Parameter.....	246
1F50h Program Data.....	248
1F51h Program Control.....	249
1F57h Program Status.....	250
1F80h NMT Startup.....	251
2005h CANopen Baudrate.....	252
2006h CANopen WheelConfig.....	253
2007h CANopen Config.....	254
2009h CANopen NodeID.....	255
2030h Pole Pair Count.....	255
2031h Max Motor Current.....	256
2034h Upper Voltage Warning Level.....	257
2035h Lower Voltage Warning Level.....	257
2036h Open Loop Current Reduction Idle Time.....	258
2037h Open Loop Current Reduction Value/factor.....	258
2038h Brake Controller Timing.....	259
2039h Motor Currents.....	261
203Ah Homing On Block Configuration.....	263
203Bh I2t Parameters.....	264
203Dh Torque Window.....	267
203Eh Torque Window Time Out.....	267
203Fh Max Slippage Time Out.....	268
2057h Clock Direction Multiplier.....	268
2058h Clock Direction Divider.....	269
205Ah Absolute Sensor Boot Value (in User Units).....	269
205Bh Clock Direction Or Clockwise/Counter Clockwise Mode.....	270
2084h Bootup Delay.....	270
2101h Fieldbus Module Availability.....	271
2102h Fieldbus Module Control.....	272
2103h Fieldbus Module Status.....	273
2290h PDI Control.....	275
2291h PDI Input.....	275
2292h PDI Output.....	277
2300h NanoJ Control.....	278
2301h NanoJ Status.....	279
2302h NanoJ Error Code.....	280
230Eh Timer.....	281
230Fh Uptime Seconds.....	282
2310h NanoJ Input Data Selection.....	282
2320h NanoJ Output Data Selection.....	283
2330h NanoJ In/output Data Selection.....	285
2400h NanoJ Inputs.....	286
2410h NanoJ Init Parameters.....	287

2500h NanoJ Outputs.....	288
2600h NanoJ Debug Output.....	289
2701h Customer Storage Area.....	290
2800h Bootloader And Reboot Settings.....	291
3202h Motor Drive Submode Select.....	292
3203h Feedback Selection.....	293
3204h Feedback Mapping.....	295
320Dh Torque Of Inertia Factor.....	297
3210h Motor Drive Parameter Set.....	298
3212h Motor Drive Flags.....	303
321Ah Current Controller Parameters.....	304
321Bh Velocity Controller Parameters.....	306
321Ch Position Controller Parameters.....	307
321Dh Pre-control.....	308
321Eh Voltage Limit.....	309
3220h Analog Input Digits.....	310
3225h Analog Input Switches.....	311
3231h Flex IO Configuration.....	312
3240h Digital Inputs Control.....	314
3242h Digital Input Routing.....	316
3243h Digital Input Homing Capture.....	317
3250h Digital Outputs Control.....	319
3252h Digital Output Routing.....	322
3320h Analog Input Values.....	324
3321h Analog Input Offsets.....	325
3322h Analog Input Numerators.....	326
3323h Analog Input Denominators.....	327
3380h Feedback Sensorless.....	328
3390h Feedback Hall.....	329
33A0h Feedback Incremental A/B/I 1.....	332
33A1h Feedback Incremental A/B/I 2.....	333
3700h Deviation Error Option Code.....	335
3701h Limit Switch Error Option Code.....	335
4012h HW Information.....	336
4013h HW Configuration.....	337
4014h Operating Conditions.....	338
4021h Ballast Configuration.....	340
4040h Drive Serial Number.....	342
4041h Device Id.....	343
4042h Bootloader Infos.....	343
6007h Abort Connection Option Code.....	345
603Fh Error Code.....	345
6040h Controlword.....	346
6041h Statusword.....	347
6042h VI Target Velocity.....	348
6043h VI Velocity Demand.....	349
6044h VI Velocity Actual Value.....	349
6046h VI Velocity Min Max Amount.....	350
6048h VI Velocity Acceleration.....	351
6049h VI Velocity Deceleration.....	352
604Ah VI Velocity Quick Stop.....	353
604Ch VI Dimension Factor.....	354
605Ah Quick Stop Option Code.....	355
605Bh Shutdown Option Code.....	356
605Ch Disable Option Code.....	357
605Dh Halt Option Code.....	357
605Eh Fault Option Code.....	358
6060h Modes Of Operation.....	358
6061h Modes Of Operation Display.....	359

6062h	Position Demand Value.....	360
6063h	Position Actual Internal Value.....	360
6064h	Position Actual Value.....	361
6065h	Following Error Window.....	361
6066h	Following Error Time Out.....	362
6067h	Position Window.....	362
6068h	Position Window Time.....	363
606Bh	Velocity Demand Value.....	363
606Ch	Velocity Actual Value.....	364
606Dh	Velocity Window.....	364
606Eh	Velocity Window Time.....	365
606Fh	Velocity Threshold.....	365
6070h	Velocity Threshold Time.....	366
6071h	Target Torque.....	366
6072h	Max Torque.....	367
6073h	Max Current.....	368
6074h	Torque Demand.....	368
6075h	Motor Rated Current.....	369
6077h	Torque Actual Value.....	369
607Ah	Target Position.....	370
607Bh	Position Range Limit.....	370
607Ch	Home Offset.....	371
607Dh	Software Position Limit.....	371
607Eh	Polarity.....	372
607Fh	Max Profile Velocity.....	373
6080h	Max Motor Speed.....	374
6081h	Profile Velocity.....	375
6082h	End Velocity.....	375
6083h	Profile Acceleration.....	375
6084h	Profile Deceleration.....	376
6085h	Quick Stop Deceleration.....	376
6086h	Motion Profile Type.....	377
6087h	Torque Slope.....	377
608Fh	Position Encoder Resolution.....	378
6090h	Velocity Encoder Resolution.....	379
6091h	Gear Ratio.....	380
6092h	Feed Constant.....	382
6096h	Velocity Factor.....	383
6097h	Acceleration Factor.....	384
6098h	Homing Method.....	385
6099h	Homing Speed.....	385
609Ah	Homing Acceleration.....	386
60A2h	Jerk Factor.....	387
60A4h	Profile Jerk.....	388
60A8h	SI Unit Position.....	390
60A9h	SI Unit Velocity.....	390
60B0h	Position Offset.....	391
60B1h	Velocity Offset.....	391
60B2h	Torque Offset.....	392
60C1h	Interpolation Data Record.....	392
60C2h	Interpolation Time Period.....	393
60C4h	Interpolation Data Configuration.....	394
60C5h	Max Acceleration.....	397
60C6h	Max Deceleration.....	397
60E4h	Additional Position Actual Value.....	397
60E5h	Additional Velocity Actual Value.....	399
60E6h	Additional Position Encoder Resolution - Encoder Increments.....	400
60E8h	Additional Gear Ratio - Motor Shaft Revolutions.....	401
60E9h	Additional Feed Constant - Feed.....	402



60EBh Additional Position Encoder Resolution - Motor Revolutions.....	403
60EDh Additional Gear Ratio - Driving Shaft Revolutions.....	404
60EEh Additional Feed Constant - Driving Shaft Revolutions.....	405
60F2h Positioning Option Code.....	406
60F4h Following Error Actual Value.....	408
60F8h Max Slippage.....	408
60FAh Control Effort.....	409
60FCh Position Demand Internal Value.....	409
60FDh Digital Inputs.....	410
60FEh Digital Outputs.....	411
60FFh Target Velocity.....	412
6502h Supported Drive Modes.....	412
6503h Drive Catalogue Number.....	413
6505h Http Drive Catalogue Address.....	414
<b>12 Copyrights.....</b>	<b>415</b>
12.1 Introduction.....	415
12.2 AES.....	415
12.3 MD5.....	415
12.4 uIP.....	416
12.5 DHCP.....	416
12.6 CMSIS DSP Software Library.....	416
12.7 FatFs.....	416
12.8 Protothreads.....	417
12.9 lwIP.....	417
12.10 littlefs.....	418

## 1 Introduction

The *NP5* is a controller for BLDC and stepper motors in plug-in module format (PCI-format connector strip) for integration in your own developments.

### NOTICE



The PCI-format connector strip is not electrically compatible with PCI Express. Under no circumstances is it to be plugged into the PC mainboard.

This manual describes the integration of the *NP5* in your motherboard and the functions of the controller. It also shows how you can address and program the controller via the communication interface.

You can find further information on the product on [us.nanotec.com](https://us.nanotec.com).

### 1.1 Version information

Manual version	Date	Changes	Firmware version	Hardware version
1.0.0	10/2017	First edition	FIR-v1650-B472161	W003a
1.0.1	04/2018	Additions and error corrections	FIR-v1650-B527540	W003a
1.0.2	04/2019	Additions and error corrections	FIR-v1650-B527540	W003a
2.0.0	10/2019	New firmware generation: see document <i>Instructions on how to perform firmware update to version: FIR-v1939</i> .	FIR-v1939	W003b
2.1.0	11/2020	<ul style="list-style-type: none"> <li>■ New firmware generation: see document <i>Instructions on how to perform firmware update to version: FIR-v2039</i>.</li> <li>■ New chapter <a href="#">External ballast circuit</a></li> </ul>	FIR-v2039	W003b
2.2.0	09/2021	Additions and error corrections	FIR-v2139	W003b
2.3.0	07/2022	<p>Werte für <i>Discovery Board NP5</i> in <a href="#">Example of a ballast circuit</a> angepasst.</p> <p>Changes in chapter <a href="#">Controller structure</a>: New objects <a href="#">321A<sub>h</sub></a>, <a href="#">321B<sub>h</sub></a>, <a href="#">321C<sub>h</sub></a>, <a href="#">321D<sub>h</sub></a> and <a href="#">321E<sub>h</sub></a> for the control parameters replace <a href="#">320E<sub>h</sub></a>.</p> <p>The current controller in <i>open-loop</i> is now only parameterized in <a href="#">3210<sub>h</sub></a>, object <a href="#">320F<sub>h</sub></a> has been removed.</p> <p>New object <a href="#">6007h</a> <a href="#">Abort Connection Option Code</a></p> <p>New object <a href="#">230Eh</a> <a href="#">Timer</a></p>	FIR-v2213	W003b

### 1.2 Copyright, marking and contact

© 2013 – 2022 Nanotec Electronic GmbH & Co. KG. All rights reserved.



Nanotec Electronic GmbH & Co. KG  
Kapellenstraße 6  
85622 Feldkirchen  
Germany

Phone: +49 89 900 686-0

Fax: +49 (89) 900 686-50

[us.nanotec.com](http://us.nanotec.com)

### 1.3 Intended use

The *NP5* serves to control stepper motors and BLDC motors and is used as a component in drive systems in a wide range of industrial applications.

The controller must be connected to motors via a PCI-format connector strip and a suitable motherboard. The system boundary of the *NP5* ends at the PCI connector strip.

Use the product as intended within the limits defined in the technical data (in particular, see [Electrical properties and technical data](#)) and the approved [Environmental conditions](#).

Under no circumstances may this Nanotec product be integrated as a safety component in a product or system. All products containing a component manufactured by Nanotec must, upon delivery to end users, contain corresponding warning notices and instructions for safe use and safe operation. All warning notices provided by Nanotec must be passed on directly to the end user.

### 1.4 Target group and qualification

The product and this documentation are directed towards technically trained specialists staff such as:

- Development engineers
- Plant engineers
- Installers/service personnel
- Application engineers

Only specialists may install, program and commission the product. Specialist staff are persons who

- have appropriate training and experience in working with motors and their control,
- are familiar with and understand the content of this technical manual,
- know the applicable regulations.

### 1.5 Warranty and disclaimer

Nanotec assumes no liability for damages and malfunctions resulting from installation errors, failure to observe this manual or improper repairs. The selection and use of Nanotec products is the responsibility of the plant engineer or end user. Nanotec accepts no responsibility for the integration of the product in the end system.

Our general terms and conditions at [www.nanotec.com](http://www.nanotec.com) apply.



### NOTICE

Changes or modifications to the product are not permitted.

## 1.6 EU directives for product safety

The following EU directives were observed:

- RoHS directive (2011/65/EU, 2015/863/EU)

## 1.7 Other applicable regulations

In addition to this technical manual, the following regulations are to be observed:

- Accident-prevention regulations
- Local regulations on occupational safety

## 1.8 Used icons

All notices are in the same format. The degree of the hazard is divided into the following classes.

### CAUTION



**The CAUTION notice indicates a possibly dangerous situation.**

Failure to observe the notice **may** result in moderately severe injuries.

- ▶ Describes how you can avoid the dangerous situation.

### NOTICE



**Indicates a possible incorrect operation of the product.**

Failure to observe the notice may result in damage to this or other products.

- ▶ Describes how you can avoid the incorrect operation.

### TIP



Shows a tip for the application or task.

## 1.9 Emphasis in the text

The following conventions are used in the document:

Underlined text indicates cross references and hyperlinks:

- The following bits in object 6041<sub>n</sub> (statusword) have a special function:
- A list of available system calls can be found in chapter NanoJ functions in the NanoJ program.

Text set in *italics* marks named objects:

- Read the *installation manual*.
- Use the *Plug & Drive Studio* software to perform the auto setup.
- For software: You can find the corresponding information in the *Operation* tab.
- For hardware: Use the *ON/OFF* switch to switch the device on.

A text set in `Courier` marks a code section or programming command:

- The line with the `od_write(0x6040, 0x00, 5 );` command has no effect.
- The NMT message is structured as follows: `000 | 81 2A`

A text in "quotation marks" marks user input:

- Start the NanoJ program by writing object `2300h`, bit 0 = "1".
- If a holding torque is already needed in this state, the value "1" must be written in `3212h:01h`.

### 1.10 Numerical values

Numerical values are generally specified in decimal notation. The use of hexadecimal notation is indicated by a subscript *h* at the end of the number.

The objects in the object dictionary are written with index and subindex as follows: `<Index>:<Subindex>`

Both the index as well as the subindex are specified in hexadecimal notation. If no subindex is listed, the subindex is `00h`.

Example: Subindex 5 of object `1003h` is addressed with `1003h:05h`, subindex 00 of object `6040h` with `6040h`.

### 1.11 Bits

The numbering of individual bits in an object always begins with the LSB (bit number 0). See the following figure, which uses data type `UNSIGNED8` as an example.

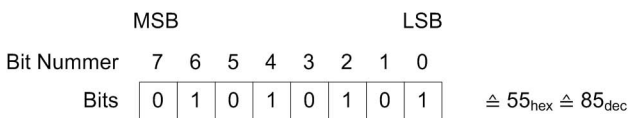

### 1.12 Counting direction (arrows)

In figures, the counting direction is always in the direction of an arrow. Objects `60C5h` and `60C6h` depicted as examples in the following figure are both specified as positive.

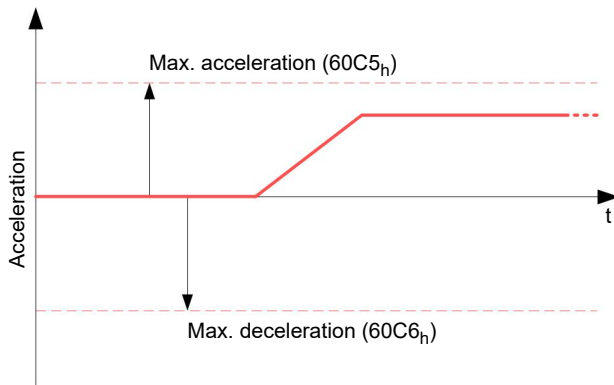

## 2 Safety and warning notices

### NOTICE

**Damage to the controller!**

Changing the wiring during operation may damage the controller.

- ▶ Only change the wiring in a de-energized state. After switching off, wait until the capacitors have discharged.

### NOTICE

**Damage to the controller due to excitation voltage of the motor!**

Voltage peaks during operation may damage the controller.

- ▶ Install suitable circuits (e. g., charging capacitor) that reduce voltage peaks.

### NOTICE

**Damage to the electronics through improper handling of ESD-sensitive components!**

The device contains components that are sensitive to electrostatic discharge. Improper handling can damage the device.

- ▶ Observe the basic principles of ESD protection when handling the device.

### NOTICE

**Damage to the electronics if the supply voltage is connected with reversed polarity!**

Polarity reversal results in a short-circuit between supply voltage and GND (earth) via the power diode.

- ▶ Install a line protection device (fuse) in the supply line.

### 3 Technical details and pin assignment

#### 3.1 Environmental conditions

Environmental condition	Value
Protection class	No IP protection
Ambient temperature (operation)	-10 ... +40°C
Air humidity (non-condensing)	0 ... 95 %
Max. Altitude of site above <i>sea level</i> (without drop in performance)	1500 m
Ambient temperature (storage)	-25 ... +85°C

#### 3.2 Dimensioned drawings

All dimensions are in millimeters.

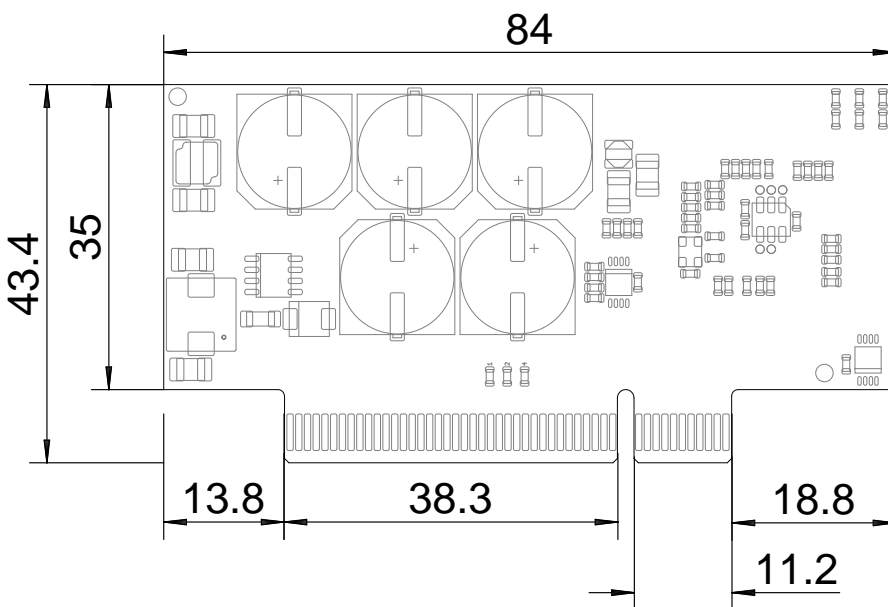

The following figures show the board layout.

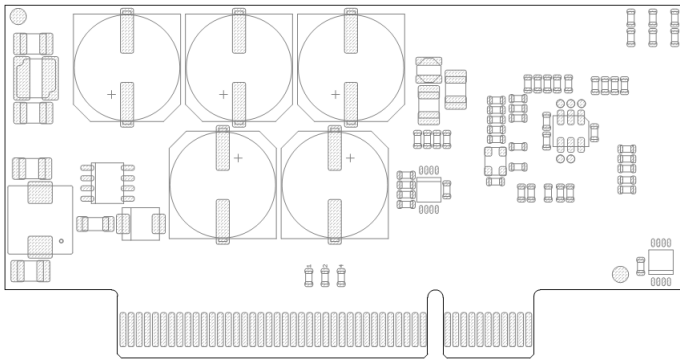

Side A

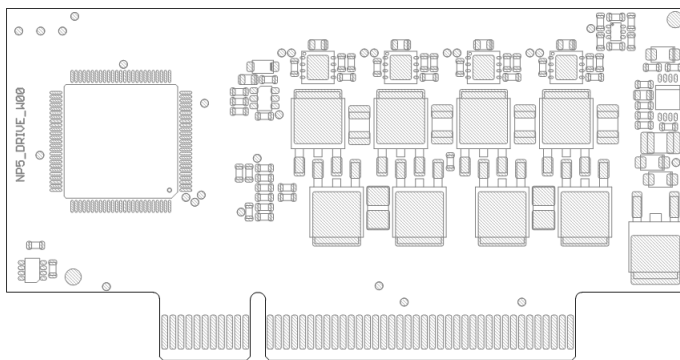

Side B

### 3.3 Electrical properties and technical data

Property	Description / value
Operating voltage	12 - 48 V DC $\pm 4\%$
Rated current	6 A <sub>rms</sub>
Peak current	10 A <sub>rms</sub> (for 1 second)
Commutation	Stepper motor <i>open loop</i> , stepper motor <i>closed loop</i> with encoder, BLDC sine commutated via Hall sensor, BLDC sine commutated via encoder <b>Note:</b> External wiring is required for encoder and Hall sensor!
Operating modes	<i>Profile Position Mode, Profile Velocity Mode, Profile Torque Mode, Velocity Mode, Homing Mode, Interpolated Position Mode, Cyclic Sync Position Mode, Cyclic Sync Velocity Mode, Cyclic Synchronous Torque Mode, Clock-Direction Mode</i>
Set value setting / programming	<i>Clock-direction, analog, NanoJ program</i>
Interfaces	1x I <sup>2</sup> C or CANopen <b>Note:</b> External wiring is required for CANopen!
Encoder/Hall	2x encoder 1x Hall sensor <b>Note:</b> External wiring is required for encoder and Hall sensor!



Property	Description / value
I/O	6x general I/O, 2x analog input, 1x output for the external brake (open drain), 1x output for the external ballast circuit
Connector	PCI Express 8x, 1.0 mm RM, 2x49 contacts
Overtemperature	Protection circuit at temperature > 75°C
Polarity reversal protection	Polarity reversal protection by power diode (short-circuit between +UB and GND, fuse necessary in supply line)
Fuse size for polarity reversal protection:	$I_{\max}$ (controller) < I (tripping current for fuse) < $I_{\max}$ (voltage supply)
Charging capacitor	For each ampere of rated current on the motor, Nanotec recommends a capacitance of approx. 1000 $\mu$ F.

#### NOTICE



- For the digital inputs, the switch-on threshold is 1.86 V, the switch-off threshold is 0.91 V.
- For the digital inputs, the maximum sampling frequency is 1 MHz.
- The range of the analog inputs is 0 ... 3.3 V.

#### TIP



If the fuse value (I tripping current for fuse) is very close to the maximum current consumption of the controller ( $I_{\max}$  controller), a *medium* / *slow* tripping characteristics should be used.

### 3.4 Overtemperature protection

Above a temperature of approx. 75 °C on the power board the power part of the controller switches off and the error bit is set (see objects [1001<sub>h</sub>](#) and [1003<sub>h</sub>](#)). After cooling down and confirming the error (see [table for the controlword](#), "Fault reset"), the controller again functions normally.

The following temperature test results provide information on the temperature behavior of this controller.

Temperature tests are performed under the following conditions:

- Operating voltage: 48 V DC
- Motor current: 6 A rms
- Operation mode: Velocity Mode, full step, 30 rpm
- Ambient temperature: 25 °C / 45 °C
- Altitude of site: 500 m above sea level
- No external cooling in the climatic chamber, e. g., via fan

The following graphic shows the results of the temperature tests:

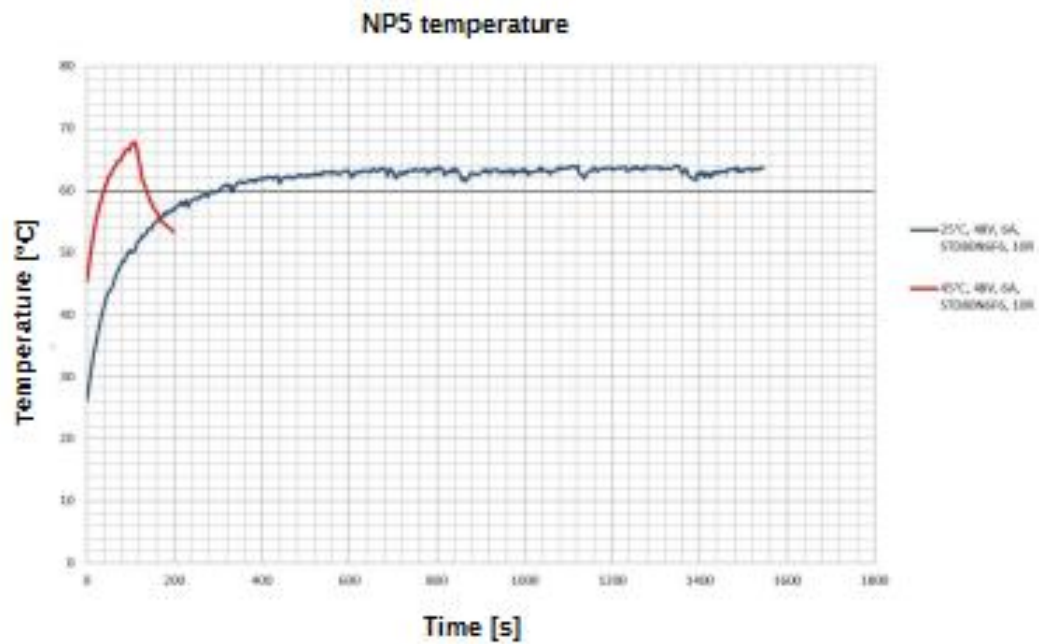

### Summary:

At 25°C (+48 V, 6 A rms, Velocity Mode 30 rpm), the controller was in operation for longer than 2 hours without having been switched off. The temperature was stable at approx. 62°C.

At 45°C (+48 V, 6 A rms, Velocity Mode 30 rpm), temperature protection switched off the controller in less than 2 minutes.

### NOTICE



Aside from the motor, the exact temperature behavior is also dependent on the flange connection and the heat transfer there as well as on the convection in the application. For this reason, we recommend always performing an endurance test in the actual environment for applications in which current level and ambient temperature pose a problem.

## 3.5 LED signaling

### 3.5.1 Power LED

The power LED indicates the current status.

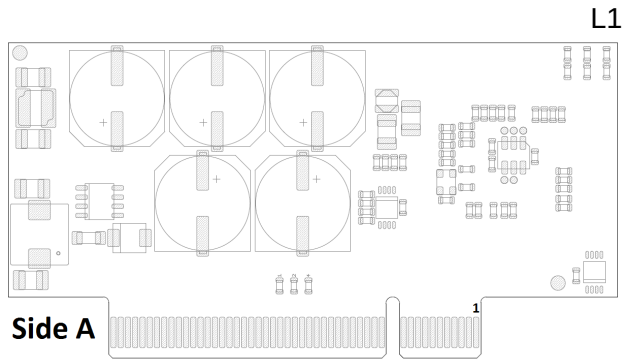

### 3.5.1.1 Normal operation

In normal operation, the green power LED flashes briefly once per second.



### 3.5.1.2 Case of an error

If an error has occurred, the LED turns red and signals an error number. In the following figure, the error number 3 is signaled.

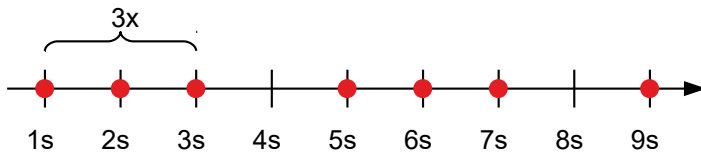

The following table shows the meaning of the error numbers.

Flash rate	Error
1	General
2	Voltage
3	Temperature
4	Overcurrent
5	Controller
6	Watchdog-Reset



#### NOTICE

For each error that occurs, a more precise error code is stored in object `1003h`.



#### TIP

You can switch off the power LEDs with `3250h:09h`.

### 3.6 Pin assignment

PIN assignment of the PCI connector strip

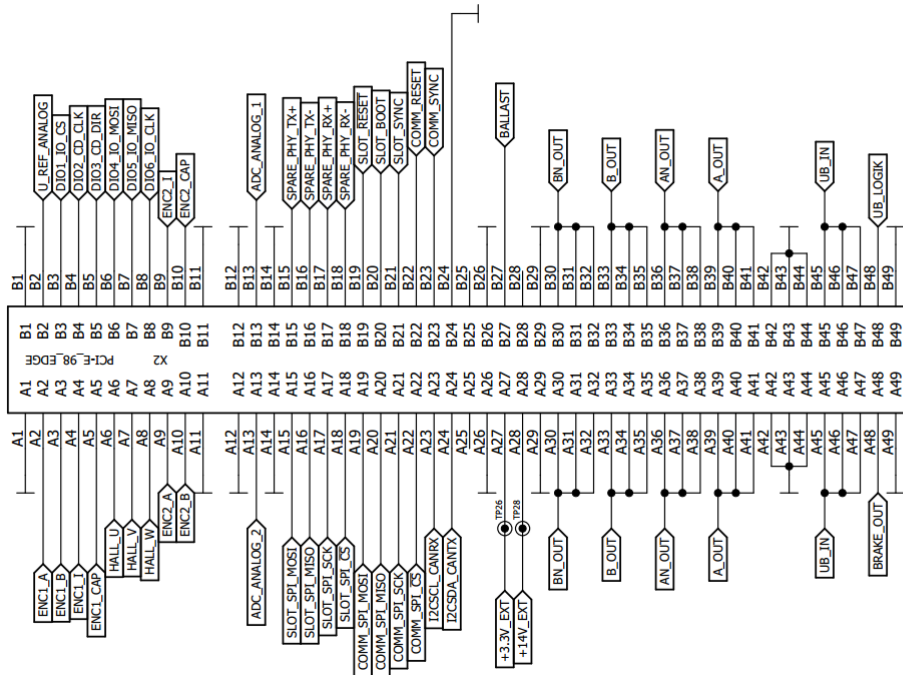

**NOTICE**



- For digital inputs 1 to 6, the switch-on threshold is 1.86 V, the switch-off threshold is 0.91 V DC. The maximum sampling frequency is 1 MHz. If the I/O pins are used as output (see Defining input and output assignments), the maximum admissible current is approx. 10 mA at 3.3 V DC.
- The range of the analog inputs is 0 ... 3.3 V DC.
- The encoder signal is single-ended, the switch-on threshold is 1.86 V, the switch-off threshold is 0.91 V DC. The maximum sampling frequency is 1 MHz.
- The current consumption of the UB\_LOGIC logic supply is approx. 30 mA at 24 V DC.

PCI pin assignment:

Pin	Name	Description/function
A1	GND	
A2	ENC1_A	Encoder 1, A
A3	ENC1_B	Encoder 1, B
A4	ENC1_I	Encoder 1, Index
A5	ENC1_CAP	Not used
A6	HALL_U (H1)	Hall sensor 1 (U)
A7	HALL_V (H2)	Hall sensor 2 (V)
A8	HALL_W (H3)	Hall sensor 3 (W)
A9	ENC2_A	Encoder 2, A
A10	ENC2_B	Encoder 2, B
A11	GND	

Pin	Name	Description/function
A12	GND	
A13	ADC_ANALOG_2	Analog input 2: 0 ... 3.3 V Node-ID, see <a href="#">Position of the virtual rotary switch</a>
A14	GND	
A15	SLOT_SPI_MOSI	
A16	SLOT_SPI_MISO	
A17	SLOT_SPI_SCK	
A18	SLOT_SPI_CS	
A19	COMM_SPI_MOSI	
A20	COMM_SPI_MISO	
A21	COMM_SPI_SCK	
A22	COMM_SPI_CS	
A23	I2CSCL_CANRX	<i>CANopen RX</i> , see <a href="#">Connecting the CANopen</a>
A24	I2CSDA_CANTX	<i>CANopen TX</i> , see <a href="#">Connecting the CANopen</a>
A25	n.c.	reserved
A26	GND	
A27	+3.3V_EXT	Not used
A28	+14V_EXT	Not used
A29	GND	
A30	BN_OUT	B\ (stepper motor)
A31		
A32		
A33	B_OUT	B\ (stepper motor) or W (BLDC)
A34		
A35		
A36	AN_OUT	A\ (stepper motor) or V (BLDC)
A37		
A38		
A39	A_OUT	A (stepper motor) or U (BLDC)
A40		
A41		
A42	GND	
A43		
A44		
A45	UB_IN	12 ... 48 V DC $\pm$ 4%
A46		
A47		
A48	BRAKE_OUT	Control of the external brake, open-drain output, max. 1 A
A49	GND	
B1	GND	

Pin	Name	Description/function
B2	U_REF_ANALOG	3.3 V DC, reference voltage for analog inputs Node-ID, see <a href="#">Position of the virtual rotary switch</a>
B3	DIO1_IO_CS	General I/O
B4	DIO2_CD_CLK	General I/O (clock input in <a href="#">clock-direction mode</a> )
B5	DIO3_CD_DIR	General I/O (direction input in <a href="#">clock-direction mode</a> )
B6	DIO4_IO_MOSI	General I/O
B7	DIO5_IO_MISO	General I/O
B8	DIO6_IO_CLK	General I/O
B9	ENC2_I	Encoder 2, Index
B10	ENC2_CAP	Not used
B11	GND	
B12	GND	
B13	ADC_ANALOG_1	Analog input 1: 0 ... 3.3 V
B14	GND	
B15	SPARE_PHY_TX+	reserved
B16	SPARE_PHY_TX-	reserved
B17	SPARE_PHY_RX+	reserved
B18	SPARE_PHY_RX-	reserved
B19	SLOT_RESET	System function, reserved
B20	SLOT_BOOT	System function, reserved
B21	SLOT_SYNC	System function, reserved
B22	COMM_RESET	
B23	COMM_SYNC	
B24	GND	
B25	n.c.	reserved
B26	GND	
B27	BALLAST	For controlling an <a href="#">external ballast circuit</a>
B28	n.c.	reserved
B29	GND	
B30	BN_OUT	B\ (stepper motor)
B31		
B32		
B33	B_OUT	B (stepper motor) or W (BLDC)
B34		
B35		
B36	AN_OUT	A\ (stepper motor) or V (BLDC)
B37		
B38		
B39	A_OUT	A (stepper motor) or U (BLDC)
B40		
B41		
B42	GND	

Pin	Name	Description/function
B43		
B44		
B45	UB_IN	12 ... 48 V DC $\pm 4\%$
B46		
B47		
B48	UB_LOGIK	External logic supply, 24 V DC
B49	GND	

## 4 Hardware installation



### NOTICE

Make certain that all components are de-energized.



### NOTICE

- The device contains components that are sensitive to electrostatic discharge.
- Improper handling can damage the device.
- Observe the basic principles of ESD protection when handling the device.

### 4.1 Connecting the controller

For easy connection, Nanotec recommends the *Discovery Board DK-NP5-48*. If you operate your controller using this *Discovery Board*, read the chapter [Connecting the NP5 controller via the Discovery Board](#).

#### 4.1.1 Integrating the NP5



### NOTICE

**EMC: Current-carrying cables – particularly around supply and motor cables – produce electromagnetic alternating fields. These can interfere with the motor and other devices.**

Suitable measures may be:

- ▶ Use shielded cables and earth the cable shielding on both ends over a short distance.
- ▶ Keep power supply and motor cables as short as possible.
- ▶ Use cables with cores in twisted pairs.
- ▶ Earth motor housing with large contact area over a short distance.
- ▶ Lay supply, motor and control cables separately.

Shown in the following figures is the circuit diagram of the *NP5 Discovery Board*, which can serve as a reference for the development of your own motherboard. You can find the pin assignment of the PCI connector strip in chapter [Pin assignment](#).

#### 1. Prepare your motherboard.

The minimum wiring varies depending on motor type and any present feedback (stepper or BLDC motor, Hall sensors/encoders). For commissioning, the connection of the voltage supply (*POWER*) of the motor and a CANopen transceiver (see also [Connecting the CANopen](#)) is sufficient.



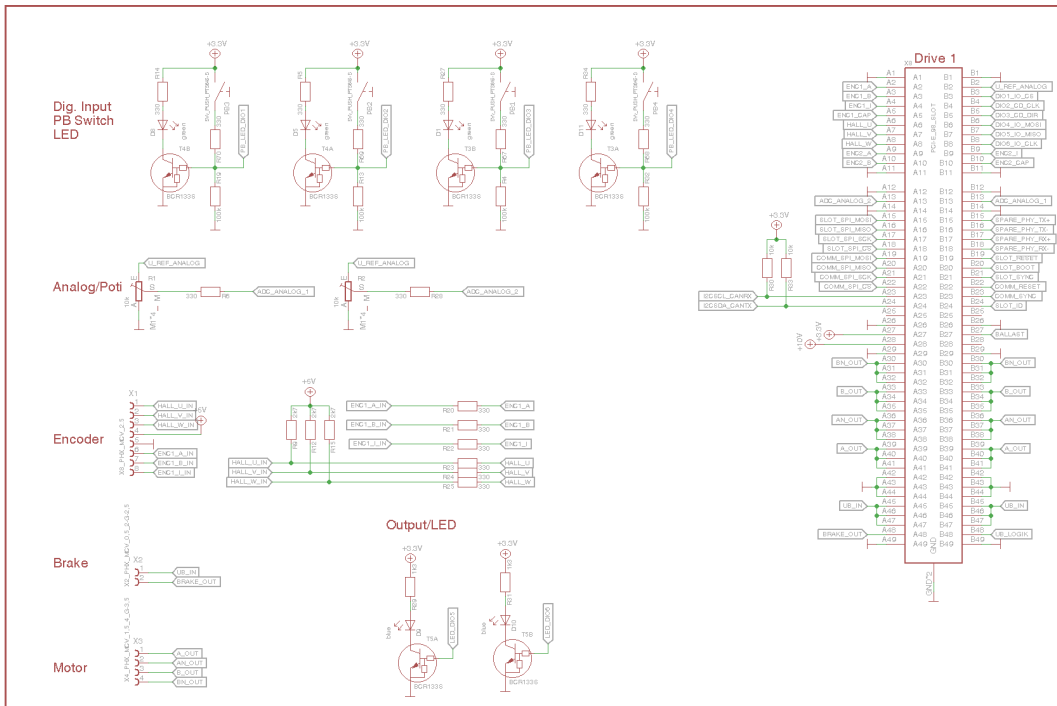
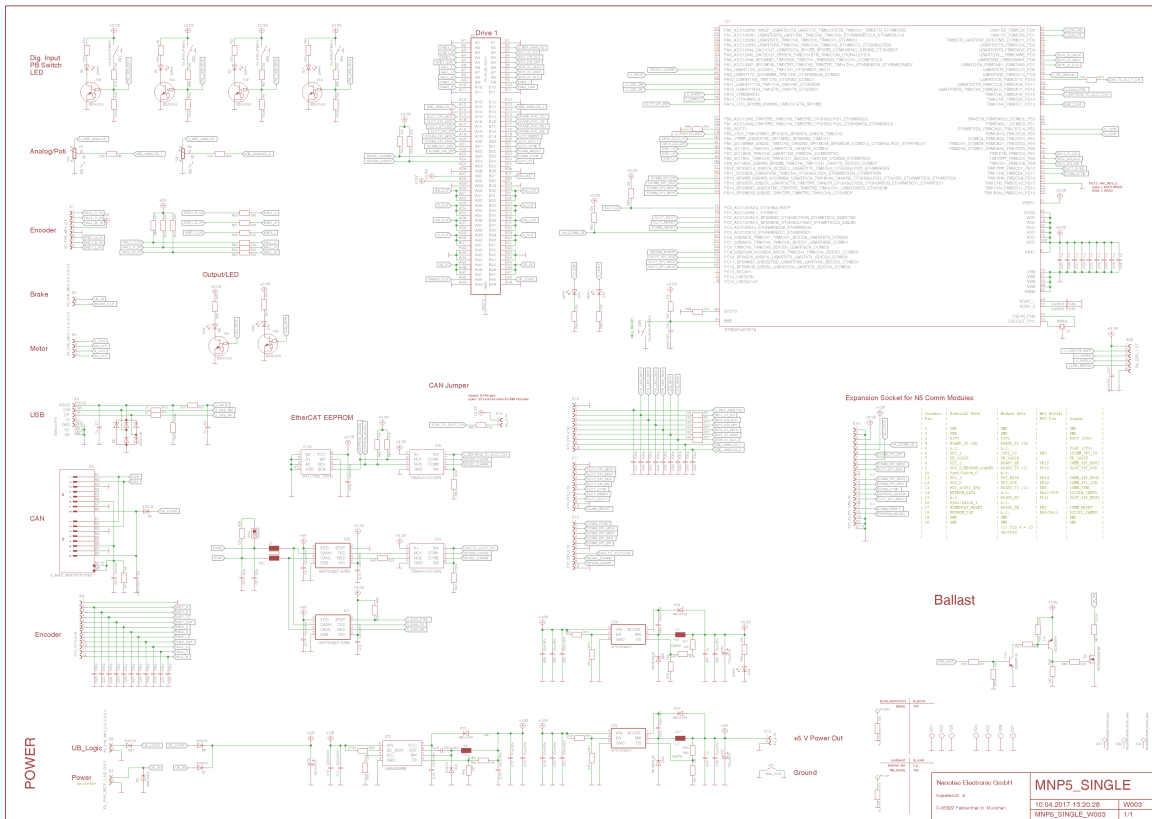

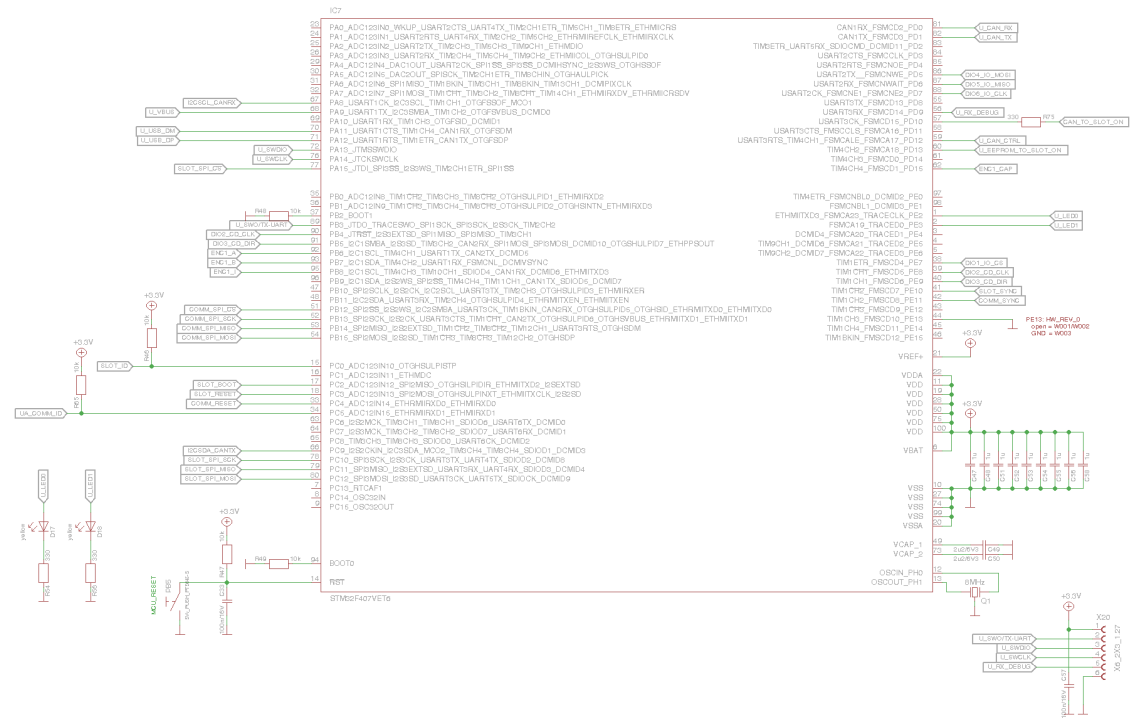

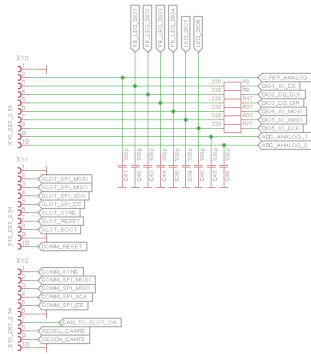

Expansion Socket for N5 Comm Modules

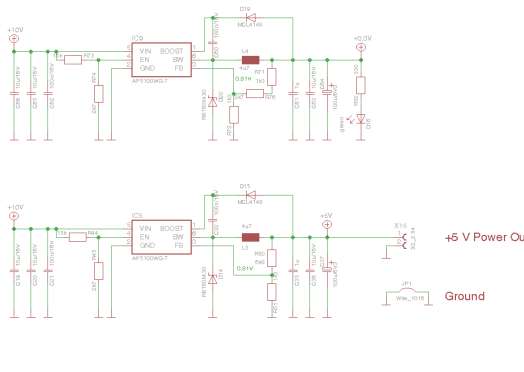
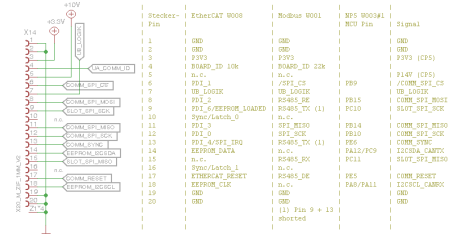

Ballast

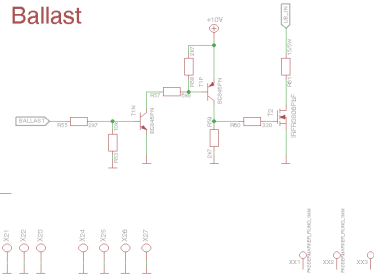

REF	VALUE	DESCRIPTION	REF	VALUE	DESCRIPTION
R1	10k	RES	R1	10k	RES
D15	1N4148	DIODE	D15	1N4148	DIODE
D19	1N4148	DIODE	D19	1N4148	DIODE
U1	MAX232	IC	U1	MAX232	IC
U2	MAX232	IC	U2	MAX232	IC
U3	MAX232	IC	U3	MAX232	IC
U4	MAX232	IC	U4	MAX232	IC
U5	MAX232	IC	U5	MAX232	IC
U6	MAX232	IC	U6	MAX232	IC
U7	MAX232	IC	U7	MAX232	IC
U8	MAX232	IC	U8	MAX232	IC
U9	MAX232	IC	U9	MAX232	IC
U10	MAX232	IC	U10	MAX232	IC
U11	MAX232	IC	U11	MAX232	IC
U12	MAX232	IC	U12	MAX232	IC
U13	MAX232	IC	U13	MAX232	IC
U14	MAX232	IC	U14	MAX232	IC
U15	MAX232	IC	U15	MAX232	IC
U16	MAX232	IC	U16	MAX232	IC
U17	MAX232	IC	U17	MAX232	IC
U18	MAX232	IC	U18	MAX232	IC
U19	MAX232	IC	U19	MAX232	IC
U20	MAX232	IC	U20	MAX232	IC
U21	MAX232	IC	U21	MAX232	IC
U22	MAX232	IC	U22	MAX232	IC
U23	MAX232	IC	U23	MAX232	IC
U24	MAX232	IC	U24	MAX232	IC
U25	MAX232	IC	U25	MAX232	IC
U26	MAX232	IC	U26	MAX232	IC
U27	MAX232	IC	U27	MAX232	IC
U28	MAX232	IC	U28	MAX232	IC
U29	MAX232	IC	U29	MAX232	IC
U30	MAX232	IC	U30	MAX232	IC
U31	MAX232	IC	U31	MAX232	IC
U32	MAX232	IC	U32	MAX232	IC
U33	MAX232	IC	U33	MAX232	IC
U34	MAX232	IC	U34	MAX232	IC
U35	MAX232	IC	U35	MAX232	IC
U36	MAX232	IC	U36	MAX232	IC
U37	MAX232	IC	U37	MAX232	IC
U38	MAX232	IC	U38	MAX232	IC
U39	MAX232	IC	U39	MAX232	IC
U40	MAX232	IC	U40	MAX232	IC
U41	MAX232	IC	U41	MAX232	IC
U42	MAX232	IC	U42	MAX232	IC
U43	MAX232	IC	U43	MAX232	IC
U44	MAX232	IC	U44	MAX232	IC
U45	MAX232	IC	U45	MAX232	IC
U46	MAX232	IC	U46	MAX232	IC
U47	MAX232	IC	U47	MAX232	IC
U48	MAX232	IC	U48	MAX232	IC
U49	MAX232	IC	U49	MAX232	IC
U50	MAX232	IC	U50	MAX232	IC
U51	MAX232	IC	U51	MAX232	IC
U52	MAX232	IC	U52	MAX232	IC
U53	MAX232	IC	U53	MAX232	IC
U54	MAX232	IC	U54	MAX232	IC
U55	MAX232	IC	U55	MAX232	IC
U56	MAX232	IC	U56	MAX232	IC
U57	MAX232	IC	U57	MAX232	IC
U58	MAX232	IC	U58	MAX232	IC
U59	MAX232	IC	U59	MAX232	IC
U60	MAX232	IC	U60	MAX232	IC
U61	MAX232	IC	U61	MAX232	IC
U62	MAX232	IC	U62	MAX232	IC
U63	MAX232	IC	U63	MAX232	IC
U64	MAX232	IC	U64	MAX232	IC
U65	MAX232	IC	U65	MAX232	IC
U66	MAX232	IC	U66	MAX232	IC
U67	MAX232	IC	U67	MAX232	IC
U68	MAX232	IC	U68	MAX232	IC
U69	MAX232	IC	U69	MAX232	IC
U70	MAX232	IC	U70	MAX232	IC
U71	MAX232	IC	U71	MAX232	IC
U72	MAX232	IC	U72	MAX232	IC
U73	MAX232	IC	U73	MAX232	IC
U74	MAX232	IC	U74	MAX232	IC
U75	MAX232	IC	U75	MAX232	IC
U76	MAX232	IC	U76	MAX232	IC
U77	MAX232	IC	U77	MAX232	IC
U78	MAX232	IC	U78	MAX232	IC
U79	MAX232	IC	U79	MAX232	IC
U80	MAX232	IC	U80	MAX232	IC
U81	MAX232	IC	U81	MAX232	IC
U82	MAX232	IC	U82	MAX232	IC
U83	MAX232	IC	U83	MAX232	IC
U84	MAX232	IC	U84	MAX232	IC
U85	MAX232	IC	U85	MAX232	IC
U86	MAX232	IC	U86	MAX232	IC
U87	MAX232	IC	U87	MAX232	IC
U88	MAX232	IC	U88	MAX232	IC
U89	MAX232	IC	U89	MAX232	IC
U90	MAX232	IC	U90	MAX232	IC
U91	MAX232	IC	U91	MAX232	IC
U92	MAX232	IC	U92	MAX232	IC
U93	MAX232	IC	U93	MAX232	IC
U94	MAX232	IC	U94	MAX232	IC
U95	MAX232	IC	U95	MAX232	IC
U96	MAX232	IC	U96	MAX232	IC
U97	MAX232	IC	U97	MAX232	IC
U98	MAX232	IC	U98	MAX232	IC
U99	MAX232	IC	U99	MAX232	IC
U100	MAX232	IC	U100	MAX232	IC

2. Plug the NP5 into the PCI plug connection.

### 4.1.2 Connecting the CANopen

The following figure shows a reference circuit for connecting the NP5 CANopen.



#### NOTICE

For the standard assignment of the pins, see Pin assignment.

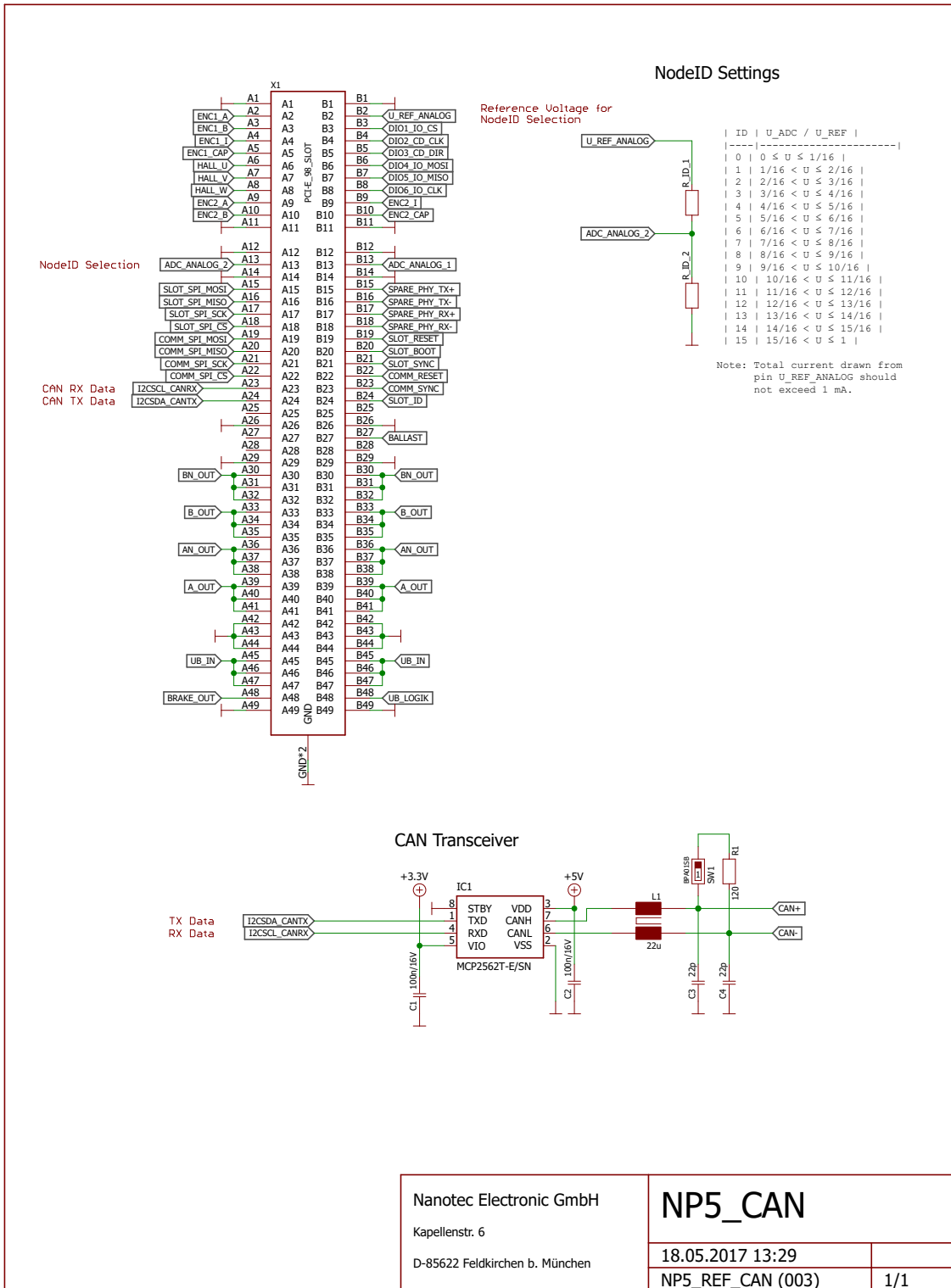

PCI-specific pin assignment for CANopen:

Pin	Name	Description/function
A13	ADC_ANALOG_2	The node-ID and baud rate can be defined via the applied voltage, see <a href="#">Position of the virtual rotary switch</a> .
A23	I2CSCL_CANRX	CANopen RX

Pin	Name	Description/function
A24	I2CSDA_CANTX	CANopen TX
B2	U_REF_ANALOG	Is used as a reference voltage of 3.3 V DC to define the node-ID and baud rate, see <a href="#">Position of the virtual rotary switch</a> .

### 4.1.3 Connecting the NP5 controller via the *Discovery Board*

The *NP5 Discover Board* helps you during tests and during the evaluation of the *NP5* controller.

The connectors necessary for the boards are supplied already installed.

Jumper X13 must be set if CANopen (*NP5-08*) is used; otherwise, you must remove it.

#### 4.1.3.1 Technical data – *NP5 Discovery Board*

Property	Description / value
Operating voltage +UB:	12 ... 48 V DC $\pm 5\%$
Logic voltage +UB_Logic:	24 V DC $\pm 5\%$
Current consumption +UB:	Max. 100 mA (without connected NP5)
Current consumption +UB_Logic:	Max. 100 mA (without connected NP5)
Communication interface:	SPI, CANopen
Analog reference voltage:	3.3 V DC $\pm 5\%$ , max. 10 mA
Digital input voltage:	Max. 3.3 V DC
DC output voltage:	5 V DC $\pm 3\%$ , max. 300 mA
Status indicator:	4x green LEDs for GPIO 1 to 4 2x blue LEDs for GPIO 5 and GPIO 6 1x green LED for Discovery Board (+3.3 V DC)
<u>Ballast resistor:</u>	15 $\Omega$ /5 W
Mounting holes:	4x $\varnothing$ 3.2 mm for Discovery Board
Weight:	0.12 kg

#### 4.1.3.2 Dimensioned drawings – *NP5 Discovery Board*

Dimensions are in [mm].

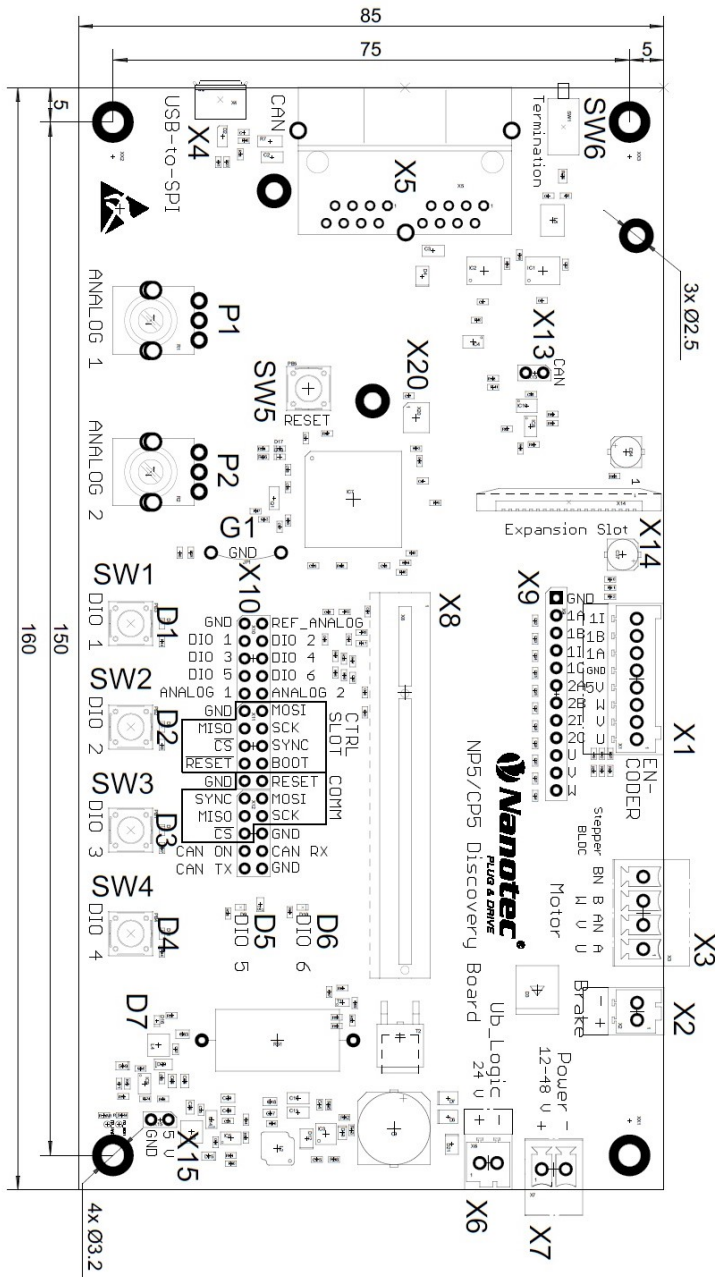

4.1.3.3 Pin assignment – NP5 Discovery Board

Connector	Function
X1	Encoder 1 and Hall sensor
X2	Brake
X3	Motor
X5	CANopen
X6	Logic voltage
X7	Voltage supply
X8	Slot for NP5 controller, see also <a href="#">Dimensioned drawings</a> and <a href="#">Pin assignment</a>
X9	Encoder 1/2 and Hall sensor
X10	GPIO and communication interface
X13	Jumper for activating / deactivating the CANopen communication
X15	+5 V DC output

Connector	Function
P1	Potentiometer for analog input 1
P2	Potentiometer for analog input 2 (for setting the node-ID and baud rate for CANopen, see also <a href="#">P2 - Analog input 2</a> )
SW1 to SW4	Buttons for GPIO 1 to GPIO 4
SW5	Reset button for the <i>Discovery Board</i>
SW6	Switch for 120 ohm termination resistor (CANopen)
D1 to D6	Status indicator for GPIO 1 to GPIO 6
D7	Status indicator for the <i>Discovery Board</i> (+3.3 V DC)
G1	Earth connection

### Connector X1 – encoder 1 and Hall sensor

Connector X1 has the following features:

- Connector type: Phoenix base strip. MCV-0.5/8-G-2.5
- Voltage level: +5 V logic level
- Maximum admissible current: Max. 300 mA (together with +5 V DC output voltage on pin header X15)
- Hall inputs: Internally by means of 2.7 k $\Omega$  pull-up resistor connected to +5 V DC

Pin	Name / function
1	Hall_U (H1)
2	Hall_V (H2)
3	Hall_W (H3)
4	+5 V DC
5	GND
6	ENC1_A
7	ENC1_B
8	ENC1_I

### Connector X2 – brake

Connector X2 has the following features:

- Connector type: Phoenix base strip. MCV-0.5/2-G-2.5

Pin	Name / function
1	Brake + (connected with +UB)
2	Brake – (PWM-controlled open-drain output, max 1.5 A)

### Connector X3 – motor

Connector X3 has the following features:

- Connector type: Phoenix base strip. MCV-1.5/4-G-3.5
- Max. rated current 6 A RMS
- Max. peak current 10 A RMS (for 1 s)

Pin	Stepper motor	BLDC motor
1	A	U

Pin	Stepper motor	BLDC motor
2	A\	V
3	B	W
4	B\	

### Connector X5 – CANopen

Connector X5 has the following features:

- Connector type: RJ45 Duo Port, horizontal

Pin	Name / function
1	CAN_H
2	CAN_L
3	GND
4	N.C
5	N.C
6	CAN_Shield
7	GND
8	+UB_Logic (24 V DC $\pm$ 5%)

### Connector X6 – logic voltage

Connector X6 has the following features:

- Connector type: Phoenix base strip. MCV-0.5/2-G-2.5

Pin	Name / function
1	+UB_Logic (24 V DC $\pm$ 5%)
2	GND

### Connector X7 – operating voltage

Connector X7 has the following features:

- Connector type: Phoenix base strip. MCV-1.5/2-G-3.5

Pin	Name / function
1	+UB (12 ... 48 V DC $\pm$ 5%)
2	GND

### Connector X9 – encoder and Hall sensors

Connector X9 has the following features:

- Connector type: Pin header, single row, RM 2.54 mm, 12-pin, vertical
- Voltage level: +5 V DC logic level

Pin	Name / function
1	GND
2	ENC1_A



Pin	Name / function
3	ENC1_B
4	ENC1_I
5	ENC1_CAP
6	ENC2_A
7	ENC2_B
8	ENC2_I
9	ENC2_CAP
10	Hall_U (H1)
11	Hall_V (H2)
12	Hall_W (H3)

### Connector X10 – I/O and communication interface

Connector X10 has the following features:

- Connector type: Pin header, two rows, RM 2.54 mm, 2x 15-pin, vertical

Pin	Name	Type	Note
1	GND	Earth	
2	U_REF_ANALOG	Out	Analog reference voltage
3	DIO1_IO_CS	I/O	General I/O
4	DIO2_CD_CLK	I/O	General I/O
5	DIO3_CD_DIR	I/O	General I/O
6	DIO4_IO_MOSI	I/O	General I/O
7	DIO5_IO_MISO	I/O	General I/O
8	DIO6_IO_CLK	I/O	General I/O
9	ADC_ANALOG_1	In	AD converter 1
10	ADC_ANALOG_2	In	AD converter 2
11	GND	Earth	
12	SLOT_SPI_MOSI	-	SPI 1
13	SLOT_SPI_MISO	-	SPI 1
14	SLOT_SPI_SCK	-	SPI 1
15	SLOT_SPI_CS	-	SPI 1
16	SLOT_SYNC	-	System function, reserved
17	SLOT_RESET	-	System function, reserved
18	SLOT_BOOT	-	System function, reserved
19	GND	Earth	
20	COMM_RESET	-	System function, reserved
21	COMM_SYNC	-	System function, reserved
22	COMM_SPI_MOSI	-	SPI 2
23	COMM_SPI_MISO	-	SPI 2
24	COMM_SPI_SCK	-	SPI 2
25	COMM_SPI_CS	-	SPI 2
26	GND	Earth	
27	CANopen ON	-	CANopen ON

Pin	Name	Type	Note
28	I2CSCL_CANRX	-	I <sup>2</sup> C Clock or CANopen RX
29	I2CSDA_CANTX	-	I <sup>2</sup> C Data or CANopen TX
30	GND	Earth	

### Connector X13 – jumper for activating / deactivating the CANopen communication

Connector X13 has the following features:

- Connector type: Pin header, RM 2.54 mm, 2-pin, vertical
- Bridged with jumper: CANopen activated
- Not bridged with jumper: CANopen deactivated

Pin	Name / function
1	+3.3V
2	CANopen ON

### Connector X15 – +5 V DC output

Connector X15 has the following features:

- Connector type: Pin header, RM 2.54 mm, 2-pin, vertical
- Maximum admissible current: Max. 300 mA (together with +5 V DC output voltage on pin header X1)

Pin	Name / function
1	+5 V DC
2	GND

### P2 - Analog input 2

The node-ID and the baud rate are defined via analog input 2. You can find further details in chapter [Communication settings](#).

To use the factory settings, set the potentiometer to 0 (turn counterclockwise as far as it will go). The factory settings are:

Node-ID 1 and baud rate 1 Mbaud.

#### 4.1.3.4 Commissioning CANopen via the Discovery Board

To establish a connection with the *NP5-08*, proceed as follows:

1. Plug in the *NP5-08* at X8.
2. Set the jumper at X13.
3. Set potentiometer P2 to 0 (counterclockwise as far as it will go)
4. Switch on the termination resistor (switch SW6 to ON).
5. Connect your CANopen cable to X2.
6. Connect your supply voltage to X7.

## 5 Commissioning

Described in this chapter is how you establish communication with the controller and set the necessary parameters to make the motor ready for operation.

The *Plug & Drive Studio* software offers a convenient option for performing the configuration and adapting the controller to the connected motor. You can find further information in document *Plug & Drive Studio: Quick Start Guide* at [us.nanotec.com](http://us.nanotec.com).

### 5.1 Communication settings

#### 5.1.1 CANopen

Described in the following chapters is how you can change the communication settings.

The controller is configured per default for node-ID 1 and a baud rate of 1 Mbaud.

##### 5.1.1.1 Setting node-ID and baud rate

Node-ID and baud rate are dependent on the position of a *virtual rotary switch* and, if applicable, on objects [2005h CANopen Baudrate](#) and [2009h CANopen NodeID](#). The position of the *virtual rotary switch* is dependent on the analog value at input ADC\_ANALOG\_2 (see [Pin assignment](#)).

##### Position of the *virtual rotary switch*

Described in the following table is how the position of the *virtual rotary switch* is composed of the analog value applied at ADC\_ANALOG\_2 and the voltage divider:

Position of the virtual rotary switch	Upper limit digit	Formula for the voltage divider calculation
0	64	$\frac{32}{1023} \times U\_REF\_ANALOG$
1	128	$\frac{96}{1023} \times U\_REF\_ANALOG$
2	192	$\frac{160}{1023} \times U\_REF\_ANALOG$
3	256	$\frac{224}{1023} \times U\_REF\_ANALOG$
4	320	$\frac{288}{1023} \times U\_REF\_ANALOG$
5	384	$\frac{352}{1023} \times U\_REF\_ANALOG$

Position of the virtual rotary switch	Upper limit digit	Formula for the voltage divider calculation
6	448	$\frac{416}{1023} \times U\_REF\_ANALOG$
7	512	$\frac{480}{1023} \times U\_REF\_ANALOG$
8	576	$\frac{544}{1023} \times U\_REF\_ANALOG$
9	640	$\frac{608}{1023} \times U\_REF\_ANALOG$
10	704	$\frac{672}{1023} \times U\_REF\_ANALOG$
11	768	$\frac{736}{1023} \times U\_REF\_ANALOG$
12	832	$\frac{800}{1023} \times U\_REF\_ANALOG$
13	896	$\frac{864}{1023} \times U\_REF\_ANALOG$
14	960	$\frac{928}{1023} \times U\_REF\_ANALOG$
15	1023	$\frac{992}{1023} \times U\_REF\_ANALOG$

### NOTICE

Observe the following for your voltage divider calculation:



- If you do not want to use the analog input for setting the address, connect the ADC\_ANALOG\_2 pin to earth or U\_REF\_ANALOG.
- The table shows suggestions for the ratio of the voltage divider; the concrete values of all resistors are to be calculated.
- U\_REF\_ANALOG is the reference voltage for the analog input, 3.3 V, see [Pin assignment](#).
- The current consumption of the voltage divider must not exceed 1 mA.

Proceed as follows to define the position of the *virtual rotary switch*:

1. Calculate the resistances for your voltage divider. You can find an example in the circuit diagram in chapter [Connecting the CANopen](#). The reference voltage U\_REF\_ANALOG (pin B2, see [Pin assignment](#)) is 3.3 V DC.
2. Wire input ADC\_ANALOG\_2 to the voltage divider.

The position of the *virtual rotary switch* is set.

### Calculating the node-ID and baud rate

Described in the following is how you define the node-ID and baud rate via the *virtual rotary switch*. An offset for the node-ID can be set in object [2006<sub>h</sub>](#).

Position of the virtual rotary switch	Node-ID	Baud rate
0	1	1 MBd
1 ... 14	1 ... 14	is read from object <a href="#">2005<sub>h</sub></a> <a href="#">CANopen Baudrate<sub>h</sub></a>
15	is read from object <a href="#">2009<sub>h</sub></a> <a href="#">CANopen NodeID</a>	is read from object <a href="#">2005<sub>h</sub></a> <a href="#">CANopen Baudrate</a>

Examples for address calculation with *node-ID offset* (see [2006<sub>h</sub>](#)).

- Value rotary switch = "1"; *node-ID offset* = "92" gives address 93 (=5D<sub>h</sub>).
- Value rotary switch = "5"; *node-ID offset* = "88" gives address 93 (=5D<sub>h</sub>).

## 5.2 Establishing communication

### 5.2.1

Before starting commissioning, we recommend reading chapters [Pin assignment](#) and [Connecting the CANopen](#).

1. Connect the CANopen master to the controller via the CAN\_L, CAN\_H cables. Check the connection of your CAN-GND and that the necessary termination resistor is present between CAN\_H and CAN\_L.
2. Supply the controller with voltage.
3. Change the configuration values if necessary, see configuration [CANopen](#).  
The controller is set per default to node-ID 1, baud rate 1 Mbaud.
4. To test the interface, send bytes 40 41 60 00 00 00 00 00 to the controller.  
Statusword (6041<sub>h</sub>) was read; you receive this response: 4B 41 60 00 XX XX 00 00.

## 5.3 Setting the motor data

Prior to commissioning, the motor controller requires a number of values from the motor data sheet.

- Number of pole pairs: Object `2030h:00h` (pole pair count) The number of motor pole pairs is to be entered here. With a stepper motor, the number of pole pairs is calculated using the step angle, e.g.,  $1.8^\circ = 50$  pole pairs,  $0.9^\circ = 100$  pole pairs (see step angle in motor data sheet). With BLDC motors, the number of pole pairs is specified directly in the motor data sheet.
- Object `2031h:00h`: maximum permissible motor current (motor protection) in mA (see motor data sheet)
- Object `6075h:00h`: rated current of the motor in mA (see motor data sheet), limited by `2031h`
- Object `6073h:00h`: maximum current (for a stepper motor, generally corresponds to the rated current, bipolar) in tenths of a percent of the set rated current (see motor data sheet). Factory settings: "1000", which corresponds to 100% of the value in `6075h`. Is limited by `2031h`.
- Object `203Bh:02h` Maximum duration of the maximum current (`6073h`) in ms (for initial commissioning, Nanotec recommends a value of 100 ms; this value is to be adapted later to the specific application).
- Setting the motor type:
  - Stepper motor:
    - Object `3202h:00h` (Motor Drive Submode Select): Defines motor type stepper motor, activates current reduction on motor standstill: 0000008h. See also chapter [Commissioning open-loop](#).
  - BLDC motor:
    - Object `3202h:00h` (Motor Drive Submode Select): Defines motor type BLDC: 00000040h
- Motor with encoder without index: You must set the encoder parameters after the [Auto setup](#), see chapter [Configuring the sensors](#).
- Motor with brake: Object `3202h:00h` (Motor Drive Submode Select): The brake control is activated for the initial commissioning. Depending on the specific application, this configuration can be deactivated later if necessary. One of the following values is to be entered depending on the motor type:
  - Stepper motor, brake control (and [current reduction](#)) activated: 0000000Ch
  - BLDC motor, brake control activated: 00000044h

### NOTICE



Due to the sine commutation and the sinusoidal current flow, the current of a motor winding can achieve an alternating current value that is briefly greater (by max.  $\sqrt{2}$  times) than the set current.

At especially slow speeds or while at a standstill with full load, one of the windings can therefore be supplied with overcurrent for a longer period of time. Take this into account when dimensioning the motor and select a motor with larger torque reserve if necessary if required by the application.

## 5.4 Connecting the motor

After setting the motor parameters, see [Setting the motor data](#), connect the motor and, if applicable, the present sensors (encoders / Hall sensors) and the brake.

### NOTICE



#### **Damage to the electronics if motor is connected incorrectly!**

- ▶ Observe the PIN assignment in chapter [Pin assignment](#) and the motor data sheet.

- Connect the motor:
  - to the corresponding pins of the PCI connector strip, see [Pin assignment](#)
  - to connector X3 of the Discovery Board, if it is used; see [Connector X3 – motor](#)
- Connect encoders / Hall sensors:

- to the corresponding pins of the PCI connector strip, see [Pin assignment](#)
- to connector X1 of the Discovery Board, if it is used; see [Connector X1 – encoder 1 and Hall sensor](#)
- Connect the brake:
  - negative to pin A48 of the PCI connector strip, see [Pin assignment](#)
  - positive to UB\_IN of the PCI connector strip or directly to the voltage supply, see [Pin assignment](#)
  - to connector X2 of the Discovery Board, if it is used; see [Connector X2 – brake](#)

How the automatic brake control can be activated is described in chapter [Automatic brake control](#).

## 5.5 Auto setup

To determine a number of parameters related to the motor and the connected sensors (encoders/Hall sensors), you must perform an auto setup.

**TIP**



As long as the motor connected to the controller or the sensors for feedback (encoders/Hall sensors) are not changed, auto setup is only to be performed once during initial commissioning.

**NOTICE**



**Note the following prerequisites for performing the auto setup:**

- ▶ The motor must be load-free.
- ▶ The motor must not be touched.
- ▶ The motor must be able to turn freely in any direction.
- ▶ No NanoJ programs may be running (object 2300<sub>h</sub>:00<sub>h</sub> bit 0 = "0", see [2300h NanoJ Control](#)).

**TIP**



Execution of the auto setup requires a relatively large amount of processor computing power. During the auto setup, this may result in fieldbuses not being operated in a timely manner.

### 5.5.1 Parameter determination

Auto setup determines various parameters of the connected motor and of the present sensors by means of multiple test runs and measurement runs. To a certain extent, the type and number of parameters are dependent on the respective motor configuration.

Parameter	All motors independent of the configuration
Motor type (stepper motor or BLDC motor)	✓
<a href="#">Winding resistance</a>	✓
<a href="#">Winding inductance</a>	✓
<a href="#">Interlinking flux</a>	✓

**NOTICE**



It is not possible to determine the interlinking flux on motors whose windings have widely differing inductances. These motors are, therefore, not suitable for sensorless *closed-loop* operation.

Parameter	Motor without encoder	Motor with encoder and index	Motor with encoder without index
Encoder resolution	-	✓	---
Alignment (shifting of the electrical zero to the index)	-	✓	---

Parameter	Motor without Hall sensor	Motor with Hall sensor
Hall transitions	-	✓

### 5.5.2 Execution

Before performing the *auto setup*, make certain that you have correctly set the necessary parameters (see [Setting the motor data](#)).

1. To preselect the *auto setup* operating mode, enter the value "-2" ("FE<sub>h</sub>") in object 6060<sub>h</sub>:00<sub>h</sub>. The *power state machine* must now switch to the *Operation enabled* state, see [CiA 402 Power State Machine](#).
2. Start *auto setup* by setting bit 4 OMS in object 6040<sub>h</sub>:00<sub>h</sub> (controlword).

While the auto setup is running, the following tests and measurements are performed in succession:

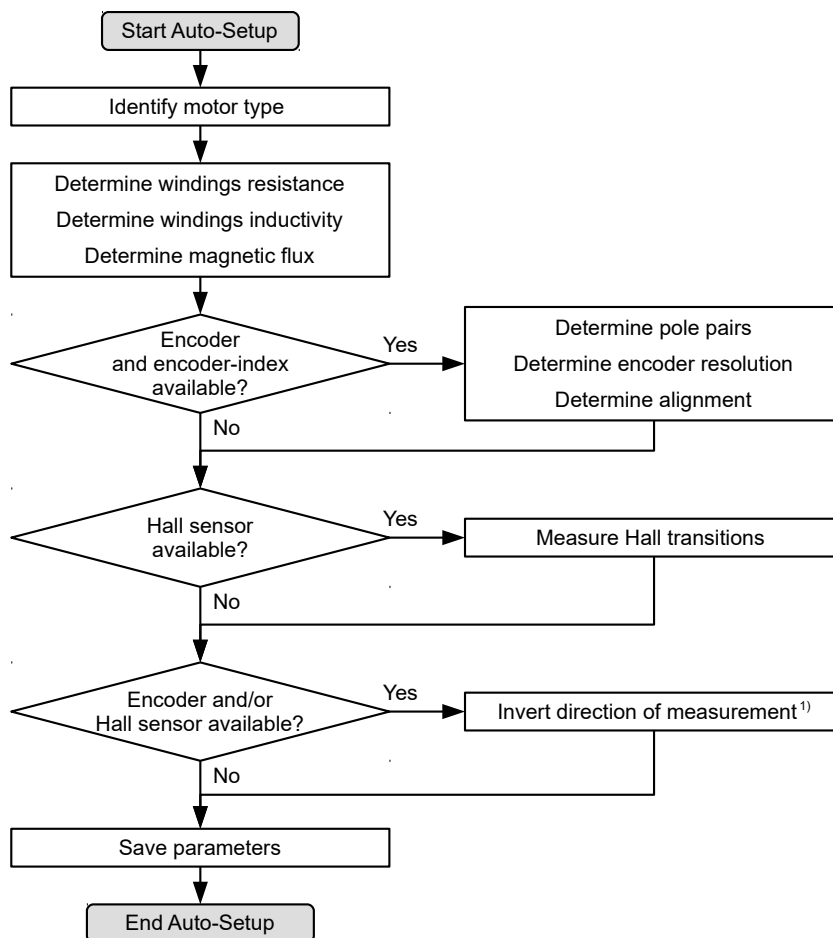

1) To determine the values, the direction of the measurement method is reversed and edge detection re-evaluated.



Value 1 in bit 12 *OMS* in object 6041<sub>h</sub>:00<sub>h</sub> (statusword) indicates that the auto setup was completely executed and ended. In addition, bit 10 *TARG* in object 6041<sub>h</sub>:00<sub>h</sub> can be used to query whether (= "1") or not (= "0") an encoder index was found.

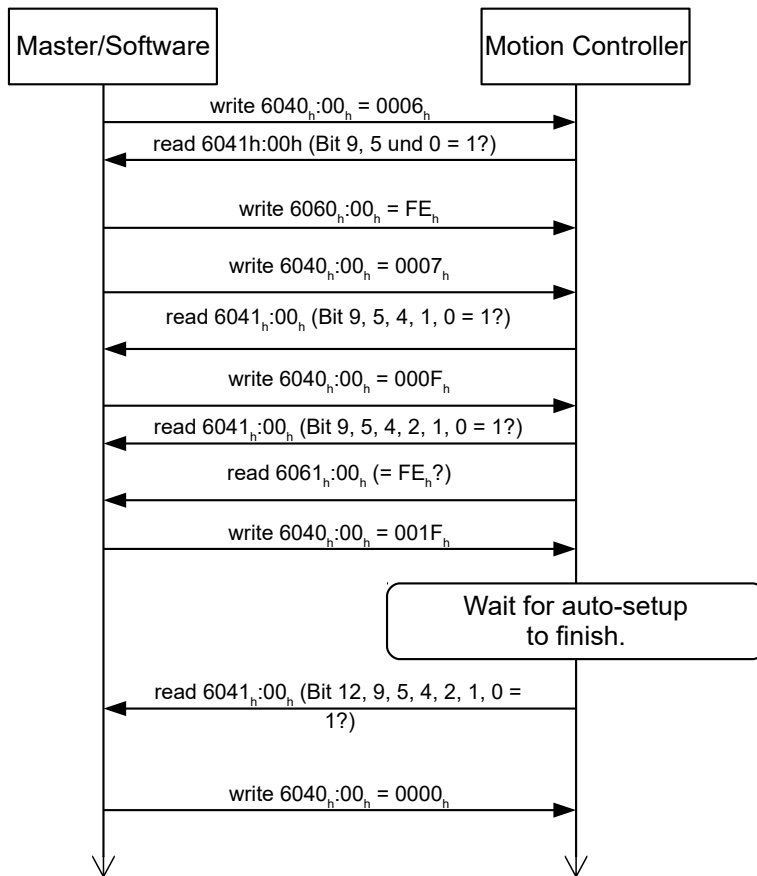

### 5.5.3 Parameter memory

After a successful *auto setup*, the determined parameter values are automatically taken over into the corresponding objects and stored with the storage mechanism, see [Saving objects](#) and [1010h Store Parameters](#). Categories *Drive* 1010<sub>h</sub>:05<sub>h</sub> and *Tuning* 1010<sub>h</sub>:06<sub>h</sub> are used.

**CAUTION**



**Uncontrolled motor movements!**

After the auto setup, the internal coordinate system is no longer valid. Unforeseen reactions can result.

- ▶ Restart the device after an auto setup. Homing alone does not suffice.

### 5.6 Configuring the sensors

The parameters (configuration, alignment, etc.) of each feedback are determined by [Auto setup](#) and stored in the following objects:

Object	Feedback	Description
3380 <sub>h</sub>	Sensorless	Contains measurement and configuration values for sensorless control

Object	Feedback	Description
<u>3390<sub>h</sub></u>	Hall sensor (digital)	contains configuration values for the Hall sensors
<u>33A0<sub>h</sub></u>	Incremental encoder 1	contains configuration values for the first incremental encoder
<u>33A1<sub>h</sub></u>	Incremental encoder 2	contains configuration values for the second incremental encoder

#### NOTICE



It is not possible to determine the resolution of encoders without index or with more than one index per motor revolution.

In this case, you must enter and store the parameters in the corresponding objects (see 3204<sub>h</sub>, 60E6<sub>h</sub> and 60EB<sub>h</sub>) (category *Tuning*, see *Saving objects*).

For external sensors that are not mounted directly on the motor shaft, you must set and store the gear ratio according to the constructive features (objects 60E8<sub>h</sub> and 60ED<sub>h</sub>) and/or the feed constant (objects 60E9<sub>h</sub> and 60EE<sub>h</sub>) (category *Application*).

#### Example

An encoder with a resolution of 2000 increments/mm was connected that is to be used in the field directly at the process for a high-precision position measurement. The constructive design was realized as follows:

Motor	Gearbox	Process	Encoder
Rotary	Rotary   Rotary	Rotary   Translational	Translational
1	i=4	Diameter 40 mm   125.6637... mm/ revolution	2000 incr./mm (62831.85 incr. per motor revolution)

You must set the resolution, gear ratio and feed constant as follows:

Object	Value
<u>60E6<sub>h</sub></u> Additional Position Encoder Resolution - Encoder Increments	1256637
<u>60EB<sub>h</sub></u> Additional Position Encoder Resolution - Motor Revolutions	20
<u>60E8<sub>h</sub></u> Additional Gear Ratio - Motor Shaft Revolutions	4
<u>60ED<sub>h</sub></u> Additional Gear Ratio - Driving Shaft Revolutions	1
<u>60E9<sub>h</sub></u> Additional Feed Constant - Feed	2513274 incr. (corresponds to 1256.637 mm)
<u>60EE<sub>h</sub></u> Additional Feed Constant - Driving Shaft Revolutions	10

You must still set the unit for the position to millimeters or other unit of length, see chapter User-defined units.

In object `3203h` you can set which of the present feedbacks the controller takes into account for each controller (current controller/commutation, velocity controller, position controller) in *closed-loop* or the determination of the actual position and actual speed in *open-loop*. See also chapter [Closed-Loop](#) and [Assignment of the feedbacks to the control loops](#).

### NOTICE



The value "0" in a subindex of the object `60E6h` means that the respective feedback is not connected and is not used. Thus, it is possible, for Example, to switch off the sensorless function to save computing time. This can be helpful if a *NanoJ* program needs the computing time.

If a value is not equal to "0" in a subindex, the controller checks the corresponding sensor when switching on. In case of an error (signal not present, invalid configuration/state), the error bit is set in the statusword and an error code stored in object `1003h`.

## 5.7 Test run

After configuring and the auto setup, a test run can be performed. As an example, the *Velocity* operating mode is used.

The values are transferred from your *CANopen master* to the controller. After every transfer, the *master* should use the status objects of the controller to ensure successful parameterization.

1. Select the *Velocity* mode by setting object `6060h` (Modes Of Operation) to the value "2".
2. Write the desired speed in `6042h`.
3. Switch the *power state machine* to the *Operation enabled* state, see [CiA 402 Power State Machine](#).

The following sequence starts *Velocity* mode; the motor turns at 200 rpm.

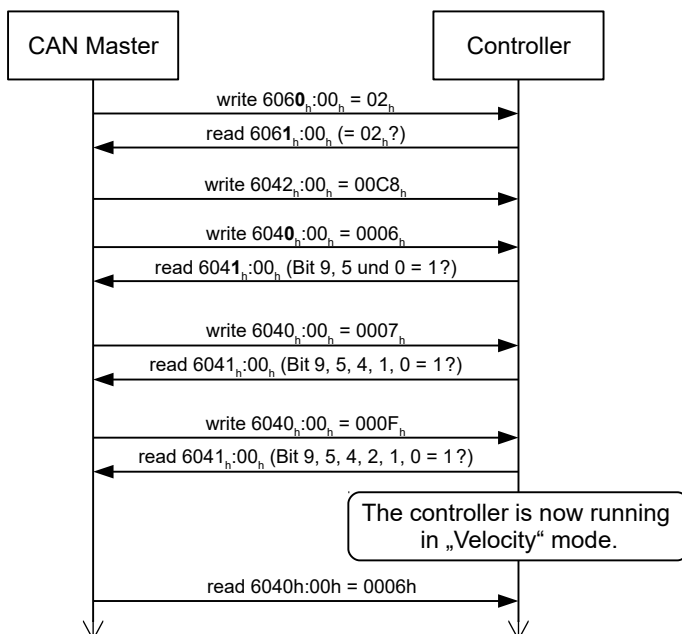

4. To stop the motor, set controlword (`6040h`) to "6".

## 6 General concepts

### 6.1 Control modes

#### 6.1.1 General

The control mode of systems without feedback is called *open-loop*, the mode with feedback is called *closed-loop*. In the *closed-loop* control mode, it is initially irrelevant whether the fed back signals come from the motor itself or from the influenced process.

For controllers with feedback, the measured control variable (actual value) is constantly compared with a set point (set value). In the event of deviations between these values, the controller readjusts according to the specified control parameters.

Pure controllers, on the other hand, have no feedback for the value that is to be regulated. The set point (set value) is only specified.

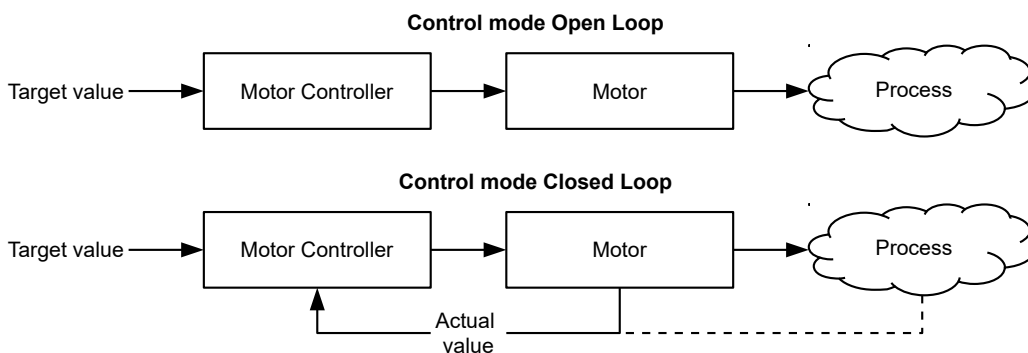

In addition to the physical feedback systems (e.g., via encoders or Hall sensors), model-based feedback systems, collectively referred to as *sensorless* systems, are also used. Both feedback systems can also be used in combination to further improve the control quality.

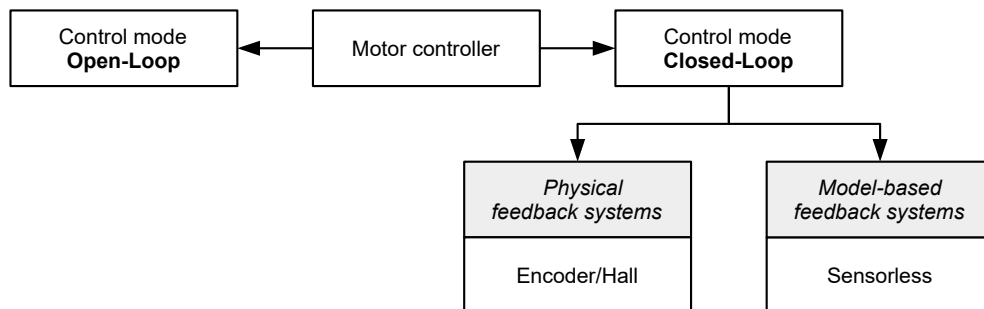

Summarized in the following are all possible combinations of control modes and feedback systems with respect to the motor technology. Support of the respective control mode and feedback is controller-specific and is described in chapters *Pin assignment* and *Operating modes*.

Control mode	Stepper motor	BLDC motor
Open-Loop	yes	no
Closed-Loop	yes	yes

Feedback	Stepper motor	BLDC motor
Hall	no	yes
Encoder	yes	yes

Feedback	Stepper motor	BLDC motor
Sensorless	yes	yes

Nanotec developed the Slow Speed control mode, which is a combination of *open-loop* and *closed-loop*, especially for applications in the low speed range. This control mode can be used if an encoder is present as feedback.

Various operating modes can be used depending on the control mode. The following list contains all the types of operation that are possible in the various control modes.

Operating mode	Control mode		
	Open-Loop	Closed-Loop	Slow Speed
Profile Position	yes	yes	yes
Velocity	yes	yes	yes
Profile Velocity	yes	yes	yes
Profile Torque	no <sup>1)</sup>	yes	no
Homing	yes <sup>2)</sup>	yes	yes
Interpolated Position Mode	yes <sup>3)</sup>	yes	yes
Cyclic Synchronous Position	yes <sup>3)</sup>	yes	yes
Cyclic Synchronous Velocity	yes <sup>3)</sup>	yes	yes
Cyclic Synchronous Torque	no <sup>1)</sup>	yes	no
Clock-direction	yes	yes	yes

1) The Profile Torque and Cyclic Synchronous Torque torque operating modes are not possible in the *open-loop* control mode due to a lack of feedback.

2) Exception: Homing on block is not possible due to a lack of feedback.

3) Because ramps and speeds in operating modes Cyclic Synchronous Position and Cyclic Synchronous Velocity follow from the specified points of the master, it is not normally possible to preselect these parameters and to ascertain whether a step loss can be excluded. It is therefore not advisable to use these operating modes in combination with *open-loop* control mode.

## 6.1.2 Open-Loop

### 6.1.2.1 Introduction

*Open-loop* mode is only used with stepper motors and is, by definition, a control mode without feedback. The field rotation in the stator is specified by the controller. The rotor directly follows the magnetic field rotation without step losses as long as no limit parameters, such as the maximum possible torque, are exceeded. Compared to *closed-loop*, no complex internal control processes are needed in the controller. As a result, the requirements on the controller hardware and the controller logic are very low. *Open-loop* mode is used primarily with price-sensitive applications and simple movement tasks.

Because, unlike *closed-loop*, there is no feedback for the current rotor position, no conclusion can be drawn on the counter torque being applied to the output side of the motor shaft. To compensate for any torque fluctuations that arise on the output shaft of the motor, in *open-loop* mode, the controller always supplies the maximum possible (e.g., specified by parameters) set current to the stator windings over the entire speed range. The high magnetic field strength thereby produced forces the rotor to assume the new steady state in a very short time. This torque is, however, opposite that of the inertia of the rotor and overall system. Under certain operating conditions, this combination is prone to resonances, comparable to a spring-mass system.

### 6.1.2.2 Commissioning

To use *open-loop* mode, the following settings are necessary:

- In object 2030<sub>h</sub> (Pole Pair Count), enter the number of pole pairs (see motor data sheet: for a stepper motor with 2 phases, a step angle of 1.8° corresponds to 50 pole pairs and 0.9° corresponds to 100 pole pairs).
- In object 2031<sub>h</sub>:00<sub>h</sub>, enter the maximum permissible motor current (motor protection) in mA (see motor data sheet)
- In object 6075<sub>h</sub>:00<sub>h</sub>, enter the rated current of the motor in mA (see motor data sheet).
- In object 6073<sub>h</sub>:00<sub>h</sub>, enter the maximum current (for a stepper motor, generally corresponds to the rated current, bipolar) in tenths of a percent of the set rated current (see motor data sheet). Factory settings: "1000", which corresponds to 100% of the value in 6073<sub>h</sub>. A value greater than "1000" is limited internally to "1000".
- In object 3202<sub>h</sub> (Motor Drive Submode Select), set bit 0 (CL/OL) to the value "0".

Nanotec recommends to activate the current reduction on motor standstill in order to reduce the power loss and heat build-up. To activate current reduction, the following settings are necessary:

- In object 3202<sub>h</sub> (Motor Drive Submode Select), set bit 3 (CurRed) to "1".
- In object 2036<sub>h</sub> (open-loop current reduction idle time), the time in milliseconds is specified that the motor must be at a standstill (set value is checked) before current reduction is activated.
- In object 2037<sub>h</sub> (open-loop current reduction value/factor), the root mean square is specified to which the rated current is to be reduced if current reduction is activated in *open loop* and the motor is at a standstill.

### 6.1.2.3 Optimizations

Depending on the system, resonances may occur in *open-loop* mode; susceptibility to resonances is particularly high at low loads. Practical experience has shown that, depending on the application, various measures are effective for largely reducing resonances:

- Reduce or increase current, see objects 6073<sub>h</sub> and 6075<sub>h</sub>, respectively. An excessive torque reserve promotes resonances.
- Reduce or increase the operating voltage, taking into account the product-specific ranges (with sufficient torque reserve). The permissible operating voltage range can be found in the product data sheet.
- Optimize the control parameters of the current controller via objects 3210<sub>h</sub>:09<sub>h</sub> (I\_P) and 3210<sub>h</sub>:0A<sub>h</sub> (I\_I) (generally not necessary).
- Adjustments to the acceleration, deceleration and/or target speed depending on the selected control mode:

#### Profile Position operating mode

Objects 6083<sub>h</sub> (Profile Acceleration), 6084<sub>h</sub> (Profile Deceleration) and 6081<sub>h</sub> (Profile Velocity).

#### Velocity operating mode

Objects 6048<sub>h</sub> (Velocity Acceleration), 6049<sub>h</sub> (Velocity Deceleration) and 6042<sub>h</sub> (Target Velocity).

#### Profile Velocity operating mode

Objects 6083<sub>h</sub> (Profile Acceleration), 6084<sub>h</sub> (Profile Deceleration) and 6081<sub>h</sub> (Profile Velocity).

#### Homing operating mode

Objects 609A<sub>h</sub> (Homing Acceleration), 6099<sub>h</sub>:01<sub>h</sub> (Speed During Search For Switch) and 6099<sub>h</sub>:02<sub>h</sub> (Speed During Search For Zero).

#### Interpolated Position Mode operating mode

The acceleration and deceleration ramps can be influenced with the higher-level controller.

#### Cyclic Synchronous Position operating mode

The acceleration and deceleration ramps can be influenced via the external "position specification / time unit" targets.

#### Cyclic Synchronous Velocity operating mode

The acceleration and deceleration ramps can be influenced via the external "position specification / time unit" targets.

### Clock-direction operating mode

Change of the step resolution via objects `2057h` (Clock Direction Multiplier) and `2058h` (Clock Direction Divider). Optimize acceleration / deceleration ramps by adjusting the pulse frequency to pass through the resonance range as quickly as possible.

## 6.1.3 Closed-Loop

### 6.1.3.1 Introduction

The *closed-loop* theory is based on the idea of a control loop. A disturbance acting on a system should be compensated for quickly and without lasting deviation to adjust the control variable back to the set point.

*Closed loop* using a speed control as an example:

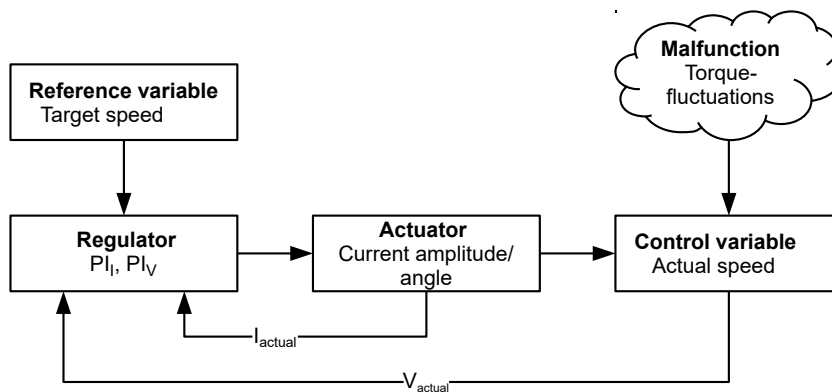

- PI<sub>I</sub> = Proportional-integral current control loop
- PI<sub>V</sub> = Proportional-integral velocity control loop
- I<sub>actual</sub> = Actual current
- V<sub>actual</sub> = Actual speed

The *closed-loop* method is also referred to as "sine commutation via an encoder with field-oriented control". At the heart of *closed-loop* technology is the performance-adjusted current control as well as the feedback of the actual values of the process. Using sensor signals, the rotor orientation is recorded and sinusoidal phase currents generated in the motor windings. Vector control of the magnetic field ensures that the magnetic field of the stator is always perpendicular to that of the rotor and that the field strength corresponds precisely to the desired torque. The current thereby controlled in the windings provides a uniform motor force and results in an especially smooth-running motor that can be precisely regulated.

The feedback of the control variables necessary for *closed-loop* mode can be realized with various technologies. In addition to the physical feedback with encoders or Hall sensors, it is also possible to virtually record the motor parameters through a software-based model calculation. Physical variables, such as speed or back-EMF, can be reconstructed with the help of a so-called "observer" from the data of the current controller. With this sensorless technology, one has a "virtual rotary encoder", which – above a certain minimum speed – supplies the position and speed information with the same precision as a real optical or magnetic encoder.

All controllers from Nanotec that support *closed-loop* mode implement a field oriented control with sine commutated current control. Thus, the stepper motors and BLDC motor are controlled in the same way as a servo motor. With *closed-loop* mode, step angle errors can be compensated for during travel and load angle errors corrected within one full step.

### 6.1.3.2 Controller structure

The controller consists of three cascaded PI controllers (proportional-integral): the current controller (commutation), the velocity controller and the position controller.

The current controller is active in all operating modes. The velocity controller is as well with the sole exception of the "Real Torque" modes (torque mode without speed limiting if bit 5 in 3202<sub>h</sub> is set to "1").

The position controller is active in the following operating modes:

- Profile Position
- Homing
- Interpolated Position Mode
- Cyclic Synchronous Position
- Clock-direction mode
- Velocity/Profile Velocity/Cyclic Synchronous Velocity if bit 1 in 3202<sub>h</sub> is set to "1"

#### NOTICE

For firmware versions from FIR-v22xx upwards, the new schema for the Controller structure applies.



The old control parameters (object 3210<sub>h</sub>) are activated in the factory settings for compatibility reasons. Object 320E<sub>h</sub>, used in firmware versions FIR-v19xx to FIR-v21xx, has been eliminated; any stored values are automatically transferred to the new objects. For new applications, Nanotec recommends using the new control parameters.

To use the new parameters, set 3212<sub>h</sub>:04<sub>h</sub> to "1". The old values are converted and entered in the new objects 321A<sub>h</sub> to 321E<sub>h</sub>. You must save all objects (see Saving objects).

Each controller consists of a proportional component with the *gain factor*  $K_p$  and an integral component with the *integrator time*  $T_i$ . The control variable (the output signal of the controller, which is the set point for the next controller) is limited by the maximum speed (position controller), the maximum current (velocity controller) or the maximum PWM signal (current controller), respectively.

Object	Name	Unit	Description
<u>321A<sub>h</sub>:01<sub>h</sub></u>	Current controller Proportional Gain $K_p$ for $I_q$	[mV/A]	Proportional component of torque-forming component
<u>321A<sub>h</sub>:02<sub>h</sub></u>	Current controller Integrator Time $T_i$ for $I_q$	[ $\mu$ s]	Integrator time of torque-forming component
<u>321A<sub>h</sub>:03<sub>h</sub></u>	Current controller Proportional Gain $K_p$ for $I_d$	[mV/A]	Proportional component of field-forming component
<u>321A<sub>h</sub>:04<sub>h</sub></u>	Current controller Integrator Time $T_i$ for $I_d$	[ $\mu$ s]	Integrator time of field-forming component
<u>321B<sub>h</sub>:01<sub>h</sub></u>	Velocity controller Proportional Gain $K_p$	[mA/Hz]	Proportional component
<u>321B<sub>h</sub>:02<sub>h</sub></u>	Velocity controller Integrator Time $T_i$	[ $\mu$ s]	Integrator time
<u>321C<sub>h</sub>:01<sub>h</sub></u>	Position controller Proportional Gain $K_p$	[Hz] (Controller deviation in mech. revolutions per second)	Proportional component



Object	Name	Unit	Description
321C <sub>h</sub> :02 <sub>h</sub>	Position controller Integrator Time Ti	[μs]	Integrator time

The *gain factor*  $K_p$  has a direct influence on the current control variable: at the same deviation, the control variable is proportional to the gain factor.

Each controller also has an integral component that is determined by the *integrator time* ( $T_i$ ). The smaller the integrator time, the faster the control variable increases. If the integrator time is 0, the integral component is internally set to "0" and the controller only has the proportional component.

### 6.1.3.3 Feed forward

It is also possible to set a *velocity feed forward*, an *acceleration feed forward* (that corresponds to a torque/current value) and a *voltage feed forward*.

You can use the *feed forward* to add an already known or anticipated control variable to the set point ("predictive"). You can, e. g., compensate for the inertia of the load by adding an acceleration feed forward value to the output of the velocity controller.

The feed forward values are additionally fed to the speed/current control loop or added to the voltage value and are immediately available. A more dynamic control can thereby be achieved.

The following figure shows the current (produced by the acceleration) during the acceleration phase as a function of the *acceleration feed forward*. At a feed forward value of "50%", the current is at "50%" already at the start of the acceleration phase; the current controller is thereby "relieved".

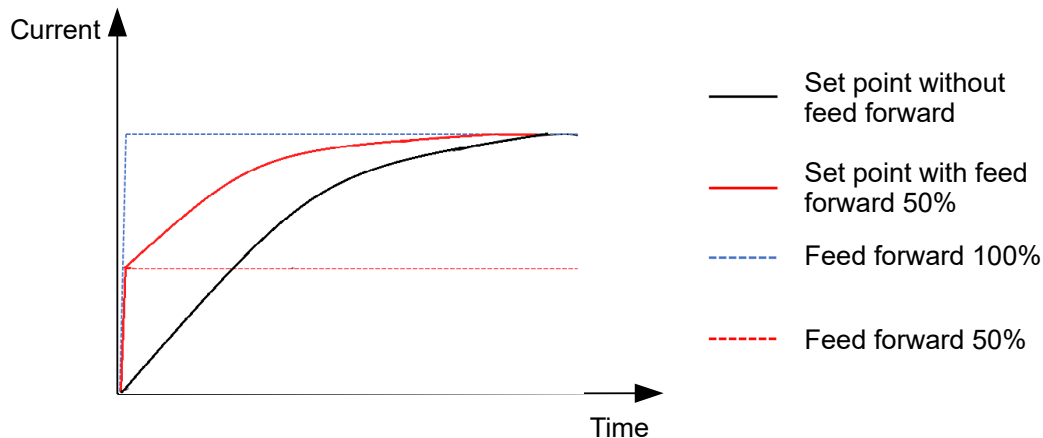

The factor for the *velocity feed forward* is set in object 321D<sub>h</sub>:03<sub>h</sub> in tenths of a percent of the output of the ramp generator (606B<sub>h</sub>) and added to the output of the position controller before the velocity controller. The *velocity feed forward* is active in all modes with position control loop:

- Profile Position
- Homing
- Interpolated Position Mode
- Cyclic Synchronous Position
- Clock-direction mode
- Velocity/Profile Velocity if bit 1 in 3202<sub>h</sub> is set to "1"

The factor for the *acceleration feed forward* is set in object 321D<sub>h</sub>:02<sub>h</sub> in tenths of a percent of the factor of 320D<sub>h</sub> and multiplied by the output of the ramp generator (6074<sub>h</sub>). The value is added to the output of the

velocity controller before the current controller. The *acceleration feed forward* is active in all modes, with the exception of the torque modes.

The following figure shows the cases in which the feed forward is active and the position of the feed forward within the controller cascade.

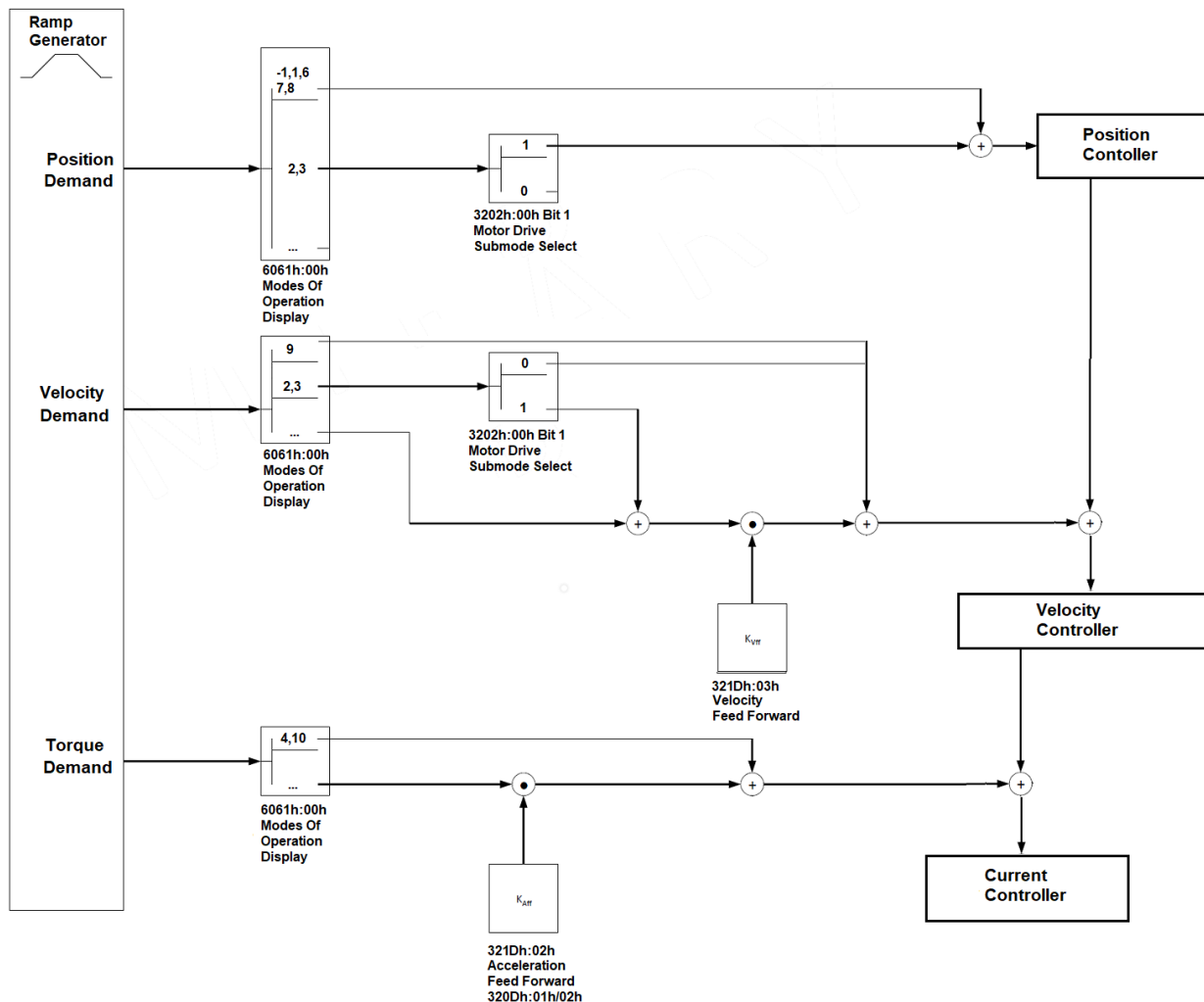

The factor for the *voltage feed forward* is specified in object  $321D_h:01_h$  in tenths of a percent of the voltage that is needed to produce the rated current. If the factor is 1000‰ (factory setting), the voltage is immediately available and the actual current quickly reaches the rated current. As a result, there is practically no control deviation during acceleration and the current controller is relieved.

The *voltage feed forward* is active in all modes. To switch it off, set  $321D_h:01_h$  to "0".

#### 6.1.3.4 Assignment of the feedbacks to the control loops

In object  $3203_h$ , you define which of the existing feedbacks the controller takes into account for the individual controllers (current controller/commutation, velocity, position). You can also use a second sensor for the commutation (see [Commutation help](#)).

Each subindex of the object contains a bit mask for the respective feedback of a sensor. The bits have the following meaning here:

- Bit 0: If the bit is set to "1", this sensor is used for position feedback.
- Bit 1: If the bit is set to "1", this sensor is used for velocity feedback.
- Bit 2: If the bit is set to "1", this sensor is used for commutation feedback in [Closed-Loop](#).

Subindex  $01_h$  always corresponds to the first (and always existing) *sensorless* feedback. The order of the remaining feedbacks corresponds to the table in chapter [Configuring the sensors](#).

Which sensor the controller takes into account for the individual controllers (commutation, velocity, position) is implicitly specified by the order of the sensors.

The search always begins with sensor 2 and continues in ascending order until all existing sensors have been queried. If a sensor is found whose feedback is set, it is assigned to the corresponding controller and the search ended.

### Example

The controller has two physical interfaces. Hall sensors and a (non-absolute) incremental encoder were connected.

Bit	Controller	Feedback 1 Sensorless	Feedback 2 Hall	Feedback 3 Incremental encoder
0	Position	0	0	1
1	Velocity	0	1	1 <sup>1</sup>
2	Commutation	0	1 <sup>2</sup>	1
<b>Index:Subindex</b>		3203 <sub>h</sub> :01 <sub>h</sub>	3203 <sub>h</sub> :02 <sub>h</sub>	3203 <sub>h</sub> :03 <sub>h</sub>

<sup>1</sup>The Hall sensors should be used for velocity control, the encoder for the positioning and commutation. Although the bit for the velocity was also set for the third feedback, this is not taken into account.

<sup>2</sup>Immediately after switching on – and until the index of the encoder is passed over for the first time – commutation is to take place via the Hall sensors and immediately enable *closed-loop* mode.

### Commutation help

Some sensors are initially lacking the alignment necessary for the commutation (offset between the index of the encoder and the magnets of the rotor). This means that the rotor orientation cannot be determined using only the position information of the sensor.

For assistance, you can set a second sensor as commutation sensor (bit 2 of the corresponding subindex in 3203<sub>h</sub>). It is thereby possible, for example, for each (electric) absolute sensor with alignment (such as a Hall sensor), to offer commutation assistance, e. g., for an incremental encoder without index or still missing alignment (index signal not yet seen since a restart). The controller automatically uses the better sensor for the commutation.

If no second commutation sensor is selected or if the alignment is missing for the selected sensors, an auto-alignment is determined in *open-loop* if necessary (independent of bit 4 in 3202<sub>h</sub>).

#### 6.1.3.5 Commissioning

An auto setup should be performed before using *closed-loop* mode. The auto setup operating mode automatically determines the necessary parameters (e.g., motor data, feedback systems) that are necessary for optimum operation of the field oriented control. All information necessary for performing the auto setup can be found in chapter Auto setup.

To use *closed-loop* mode, certain settings are necessary depending on the motor type and feedback; see chapter Setting the motor data.

Bit 0 in 3202<sub>h</sub> must be set. The bit is set automatically after a successfully completed auto setup.

## Activation

If an (electric) absolute sensor (e.g., Hall sensor) is used for the commutation, the *closed-loop* is activated automatically already when switching on.

If an encoder is used for the commutation, the index of the encoder must be passed over at least once after switching on before *closed-loop* can be activated (remains in *open-loop* mode until this takes place).

If no index is present or if it cannot be used, you can:

- use a second sensor for commutation (see [Assignment of the feedbacks to the control loops](#))
- or have an *auto alignment* determined in *open-loop* by setting bit 4 in `3202h` to "1".  
*Auto alignment* is determined once every time the controller is restarted after the first command that switches the [CiA 402 Power State Machine](#) to the *Operation enabled* state.  
 In doing so, the rotor is moved up to a magnetic pole. After the alignment has been determined, the *Operation enabled* state is reached and travel continues if applicable.

### NOTICE



To be able to determine the *auto alignment*, you must ensure that the (automatic or manual) brake control is deactivated (see chapter [Automatic brake control](#)).

### CAUTION

#### Uncontrolled motor movements!

Unforeseeable reactions can result if the alignment is not correctly determined.

Please observe the following requirements for the use of auto alignment:

- ▶ The motor shaft must ideally be load-free. If this is not possible, the motor must be designed so that there is a large torque reserve (at least 25%).
- ▶ Use an encoder with sufficiently high resolution (at least 500 counts per revolution, after quadrature, for a motor with 50 pole pairs)

Bit 15 in `6041h Statusword` indicates whether or not *closed-loop* is active (if the state of [CiA 402 Power State Machine](#) is *Operation enabled*).

### 6.1.3.6 Optimizations

In *closed-loop*, the measured control variable (actual value) is constantly compared with a set point (set value). In the event of deviations between these values, the controller readjusts according to the specified control parameters.

The objective of control parameter optimization (the so-called *tuning* of the controller) is the smoothest possible running of the motor, high accuracy and high dynamics in the reaction of the controller to faults. All control deviations should be eliminated as quickly as possible.

Due to the cascaded [Controller structure](#), it is useful to start the optimization of the inner-most controller (current controller) before the velocity and – if applicable – the position controller are optimized. Each of the three controllers consists of a proportional and an integral component, which should normally be adjusted in this order.

The following figures show the reaction of the controller to a change in set value.

If the proportional component is too small, the actual value remains below the set value. A proportional component that is too large, on the other hand, results in "overshooting".

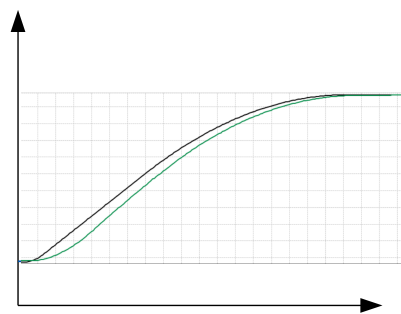

P-part too small

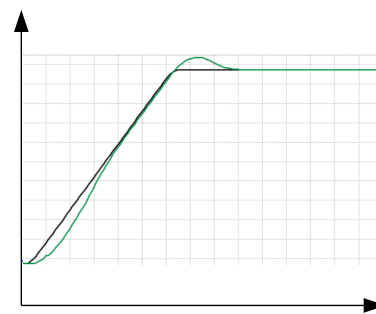

P-part too big

If the integrator time is too small, the system tends toward oscillations. If the integrator time is too large, the deviations are compensated for too slowly.

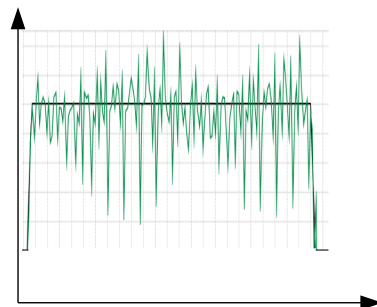

Ti too small

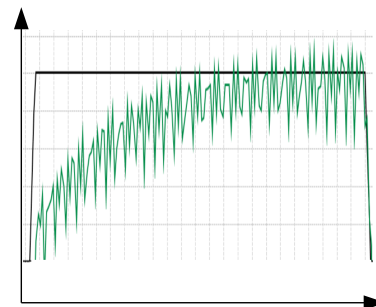

Ti too big

### CAUTION

#### Risk of injury through uncontrolled motor movements!

Incorrect control parameters may result in an unstable control behavior. Unforeseen reactions can result.

- ▶ Increase the control parameters slowly and incrementally. Do not increase these further if you notice strong vibrations/oscillations.
- ▶ Do not reach for moving parts during operation. After switching off, wait until all movements have ended.



## 6.1.4 Slow Speed

### 6.1.4.1 Introduction

The *slow speed* mode combines the advantages of *open-loop* and *closed-loop* technologies in a low speed range and can be used if an encoder is present as feedback. *Slow speed* offers following error monitoring but is more smooth-running than in pure *closed-loop* mode at low speeds.

The rotor orientation is detected via the signals of the encoder. To calculate the speed, the change of position is divided by the (fixed) cycle time. At low speeds, the controller counts fewer (or even no) encoder increments in one cycle, which leads to a speed curve with a relatively high number of peaks (in spite of the used low-pass filter).

Due to the cascaded control loop, this results in current peaks in *closed-loop* mode, which can lead to uneven running, as the following figure shows.

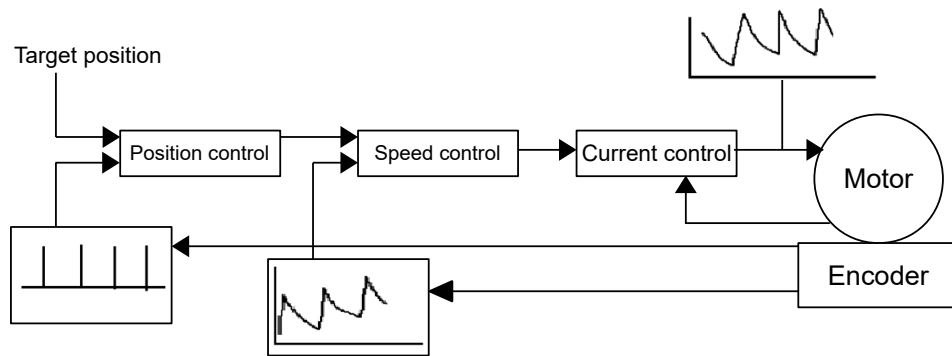

In the *slow speed* mode, the motor instead operates with constant phase current, as in *open-loop*. The following error is, however, monitored by means of the encoder and the vector control of the magnetic field is activated if necessary, as in *closed-loop*.

**6.1.4.2 Activation**

To activate the *slow speed* mode, you must:

1. activate closed-loop,
2. in object `3202h` (Motor Drive Submode Select), set bit 7 to "1".

The changeover between *slow speed* and *closed-loop* occurs automatically at a speed that is dependent on the physical encoder resolution, with a hysteresis of 10%. This fixed changeover speed is calculated in revolutions per minute as follows:

$$\frac{4000}{\text{Encoder resolution (ppr)}} \times 60$$

The following figure shows the changeover as a function of speed in both directions.

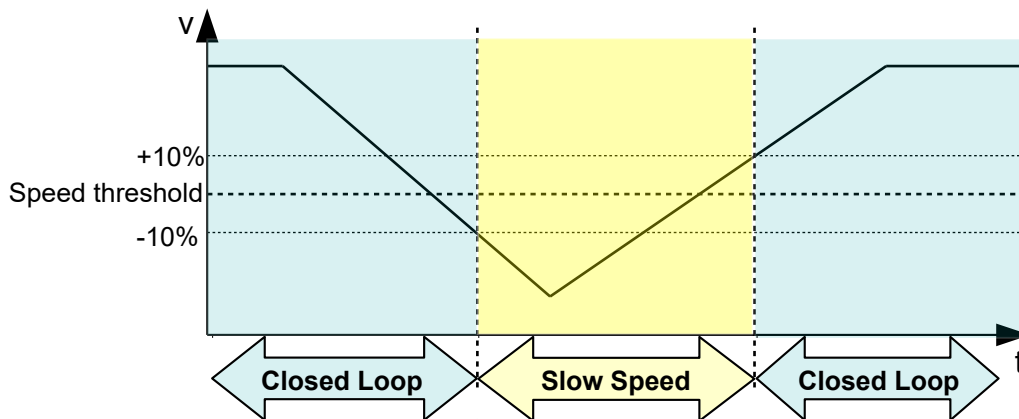

While at a standstill, the motor is in *closed-loop* mode.

### 6.1.4.3 Optimizations

The entire phase current remains constant as in *open-loop*. Depending on the system, resonances may occur that you can avoid by adjusting the motor current and/or the acceleration ramp. See also chapter [Open-Loop](#).

During operation at various speed ranges, if changing between *closed-loop* and *slow speed*, it may be necessary to:

- reduce the motor current (objects [6075<sub>h</sub>](#), [6073<sub>h</sub>](#)) if changing from *closed-loop* to *slow speed*,
- ascertain various control parameters (see [Controller structure](#)) for each speed range.

## 6.2 CiA 402 Power State Machine

### 6.2.1 State machine

#### 6.2.1.1 CiA 402

To switch the controller to the ready state, it is necessary to run through a *state machine*. This is defined in *CANopen standard 402*. State changes are requested in object [6040<sub>h</sub>](#) (controlword). The actual state of the state machine can be found in object [6041<sub>h</sub>](#) (statusword).

#### 6.2.1.2 Controlword

State changes are requested via object [6040<sub>h</sub>](#) (controlword).

#### State transitions

The diagram shows the possible state transitions.

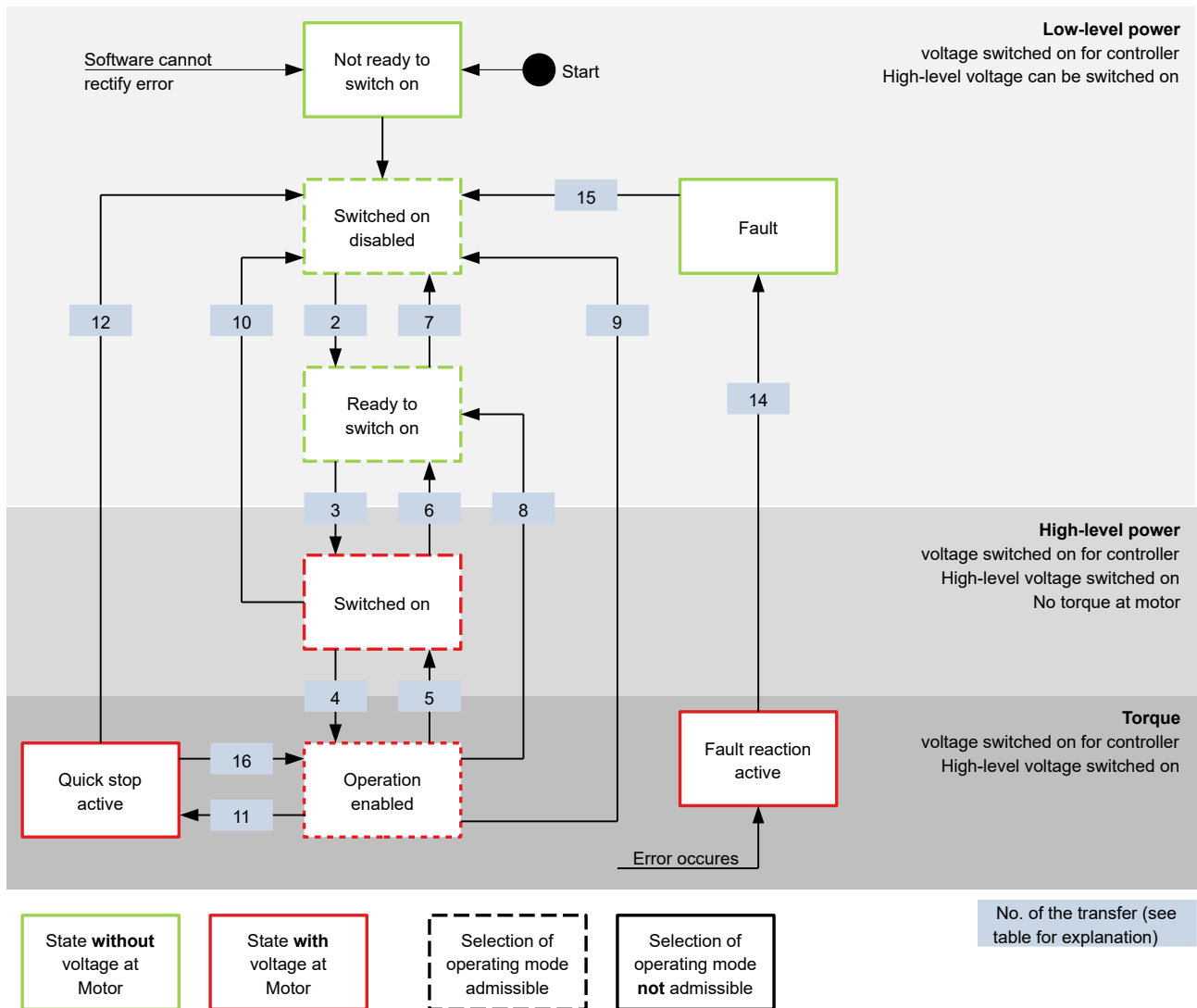

Listed in the following table are the bit combinations for the controlword that result in the corresponding state transitions. An X here corresponds to a bit state that requires no further consideration. Exceptions are the resetting of the error (fault reset) and the changeover from *Quick Stop Active* to *Operation Enabled*: the transition is only requested by the rising edge of the bit.

Command	Bit in object 6040 <sub>h</sub>					Transition
	Bit 7	Bit 3	Bit 2	Bit 1	Bit 0	
Shutdown	0	X	1	1	0	2, 6, 8
Switch on	0	0	1	1	1	3
Disable voltage	0	X	X	0	X	7, 10, 9, 12
Quick stop	0	X	0	1	X	11
Disable operation	0	0	1	1	1	5
Enable operation	0	1	1	1	1	4
Enable operation after Quick stop	0	1		1	1	16



Command	Bit in object 6040 <sub>h</sub>					Transition
	Bit 7	Bit 3	Bit 2	Bit 1	Bit 0	
Fault / warning reset		X	X	X	X	15

### 6.2.1.3 Statusword

Listed in the following table are the bit masks that break down the state of the controller.

Statusword (6041 <sub>h</sub> )	State
xxxx xxxx x0xx 0000	Not ready to switch on
xxxx xxxx x1xx 0000	Switch on disabled
xxxx xxxx x01x 0001	Ready to switch on
xxxx xxxx x01x 0011	Switched on
xxxx xxxx x01x 0111	Operation enabled
xxxx xxxx x00x 0111	Quick stop active
xxxx xxxx x0xx 1111	Fault reaction active
xxxx xxxx x0xx 1000	Fault

After switching on and successfully completing the self-test, the controller reaches the *Switch on disabled* state.

#### NOTICE



If an unrecoverable error occurs, the controller changes to the *Not ready to switch on* state and remains there.

### 6.2.1.4 Operating mode

The operating mode is set in object 6060<sub>h</sub>. The actually active operating mode is displayed in 6061<sub>h</sub>.

The operating mode can be set or changed at any time.

## 6.2.2 Behavior upon exiting the *Operation enabled* state

### 6.2.2.1 Halt motion reactions

Various halt motion reactions can be programmed upon exiting the *Operation enabled* state.

The following graphic shows an overview of the halt motion reactions.

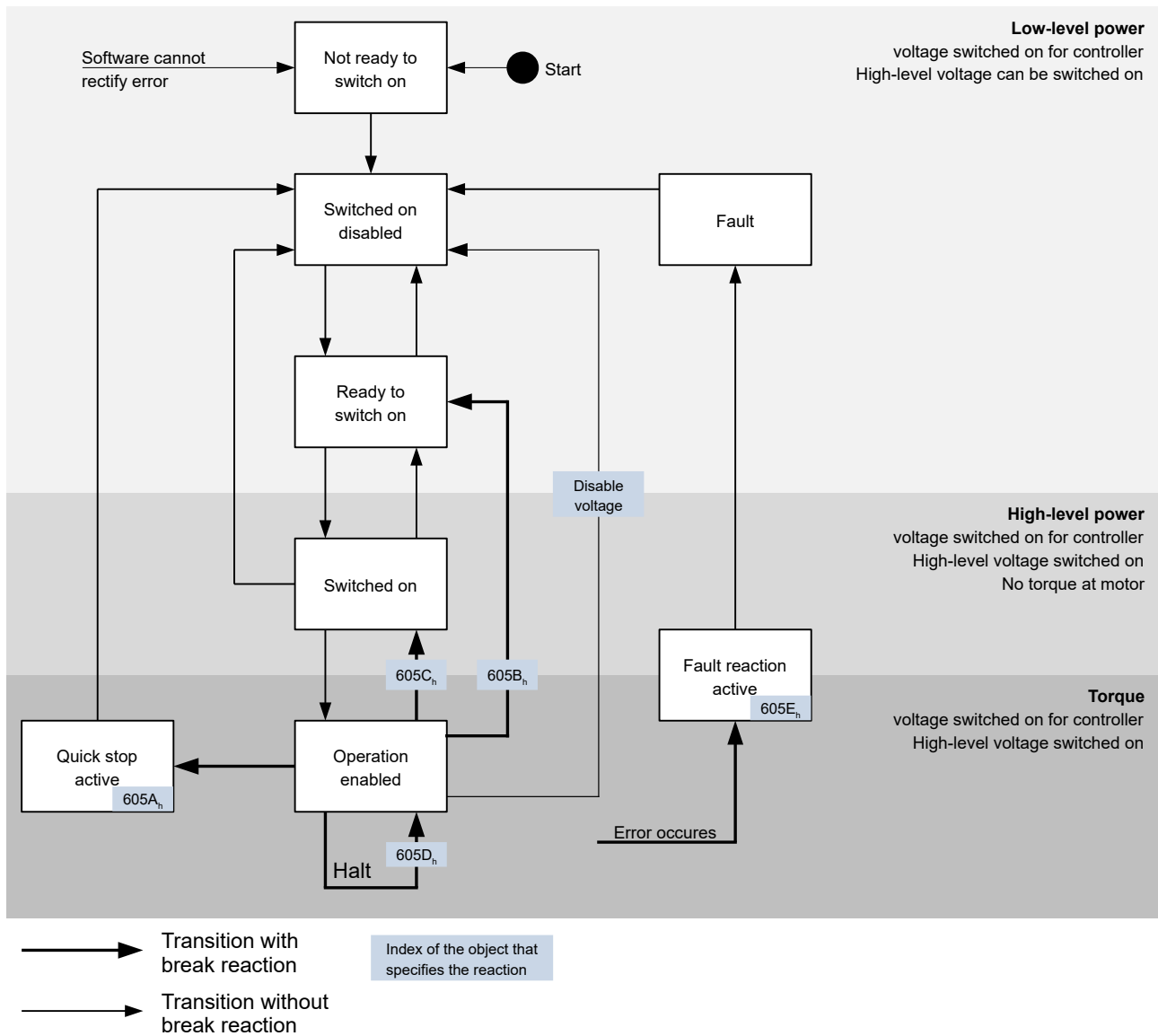

### 6.2.2.2 Quick stop active

Transition to the *Quick stop active* state (quick stop option):

In this case, the action stored in object 605A<sub>n</sub> is executed (see following table).

Value in object 605A <sub>n</sub>	Description
0	Switch off driver without deceleration ramp; drive function blocked – motor can turn freely
1	Braking with <i>slow down ramp</i> (deceleration ramp depending on operating mode) and subsequent state change to <i>Switch on disabled</i>
2	Braking with <i>quick stop ramp</i> (6085 <sub>n</sub> ) and subsequent state change to <i>Switch on disabled</i>
5	Braking with <i>slow down ramp</i> (deceleration ramp depending on operating mode) and subsequent state change to <i>Quick stop active</i> ; control does not switch off and the motor remains energized. You can switch back to the <i>Operation enabled</i> state.

Value in object 605A <sub>h</sub>	Description
6	Braking with <i>quick stop ramp</i> (6085 <sub>h</sub> ) and subsequent state change to <i>Quick Stop Active</i> ; control does not switch off and the motor remains energized. You can switch back to the <i>Operation enabled</i> state.

The *Quick stop active* state can also be reached when a limit switch is actuated; see [Limitation of the range of motion](#).

### 6.2.2.3 Ready to switch on

Transition to the *Ready to switch on* state (shutdown option):

In this case, the action stored in object 605B<sub>h</sub> is executed (see following table).

Value in object 605B <sub>h</sub>	Description
-32768 ... -1	Reserved
0	Switch off driver without deceleration ramp; drive function blocked – motor can turn freely
1	Braking with <i>slow down ramp</i> (braking deceleration depending on operating mode) and subsequent state change to <i>Ready to switch on</i>
2 ... 32767	Reserved

### 6.2.2.4 Switched on

Transition to the *Switched on* state (disable operation option):

In this case, the action stored in object 605C<sub>h</sub> is executed (see following table).

Value in object 605C <sub>h</sub>	Description
-32768 ... -1	Reserved
0	Switch off driver without deceleration ramp; drive function blocked – motor can turn freely
1	Braking with <i>slow down ramp</i> (braking deceleration depending on operating mode) and subsequent state change to <i>Switched on</i>
2 ... 32767	Reserved

### 6.2.2.5 Halt

The bit is valid in the following modes:

- [Profile Position](#)
- [Velocity](#)
- [Profile Velocity](#)
- [Profile Torque](#)
- [Interpolated Position Mode](#)

When setting bit 8 in object 6040<sub>h</sub> (controlword), the action stored in 605D<sub>h</sub> is executed (see following table):

Value in object 605D <sub>h</sub>	Description
-32768 ... 0	Reserved
1	Braking with <i>slow down ramp</i> (braking deceleration depending on operating mode)

Value in object 605D <sub>h</sub>	Description
2	Braking with <i>quick stop ramp</i> (6085 <sub>h</sub> )
3 ... 32767	Reserved

### 6.2.2.6 Fault

Case of an error (fault):

If an error occurs, the motor will brake according to the value stored in object 605E<sub>h</sub>.

Value in object 605E <sub>h</sub>	Description
-32768 ... -1	Reserved
0	Switch off driver without deceleration ramp; drive function blocked – motor can turn freely
1	Braking with <i>slow down ramp</i> (braking deceleration depending on operating mode)
2	Braking with <i>quick stop ramp</i> (6085 <sub>h</sub> )
3 ... 32767	Reserved

For each error that occurs, a more precise error code is stored in object 1003<sub>h</sub>.

### 6.2.2.7 Following/slippage error

If a following or slippage error occurs, the motor is braked according to the value stored in object 3700<sub>h</sub>.

Value	Description
-32768 ... -2	Reserved
-1	no reaction
0	Switch off driver without deceleration ramp; drive function blocked – motor can turn freely
1	Braking with <i>slow down ramp</i> (braking deceleration depending on operating mode)
2	Braking with <i>quick stop ramp</i> (6085 <sub>h</sub> )
3 ... 32767	reserved

You can deactivate error monitoring by setting object 6065<sub>h</sub> to the value "-1" (FFFFFFFF<sub>h</sub>) or object 60F8<sub>h</sub> to the value "7FFFFFFFF<sub>h</sub>".

## 6.3 User-defined units

The controller offers you the possibility to set user-defined units. It is thereby possible to set and read out the corresponding parameters, e.g., directly in degrees [°], millimeter [mm], etc.

Depending on the mechanical circumstances, you can also define a Gear ratio and/or a Feed constant.

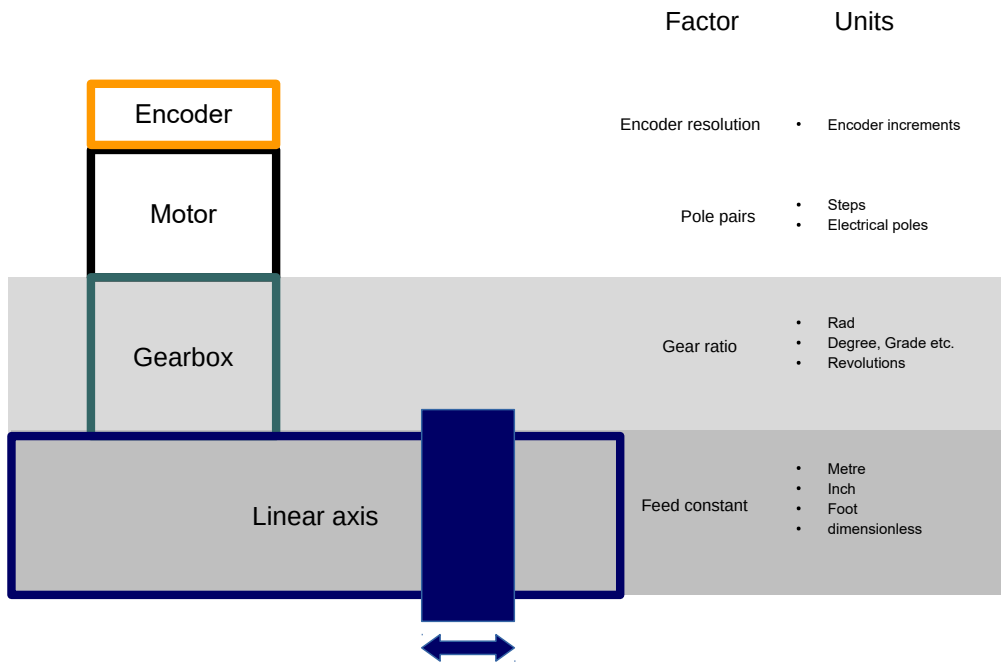

**NOTICE**



Value changes of all objects that are described in this chapter are not immediately applied in the *Operation enabled* state of the CiA 402 Power State Machine. For this to happen, the *Operation enabled* state must be exited.

### 6.3.1 Units

Units of the international unit system (SI) as well as a number of specific units are supported. It is also possible to specify a power of ten as a factor.

Listed in the following table are all supported units for the position and their values for 60A8<sub>h</sub> (Position unit) or 60A9<sub>h</sub> (Speed unit). Depending on the unit that is used, Feed constant (6092<sub>h</sub>) and/or Gear ratio (6091<sub>h</sub>) are/is taken into account.

Name	Unit symbol	Value	6091 <sub>h</sub>	6092 <sub>h</sub>	Description
meter	m	01 <sub>h</sub>	yes	yes	<i>Meter</i>
inch	in	C1 <sub>h</sub>	yes	yes	<i>Inch</i> (=0.0254 m)
foot	ft	C2 <sub>h</sub>	yes	yes	<i>Foot</i> (=0.3048 m)
grade	g	40 <sub>h</sub>	yes	no	<i>Gradian</i> (unit of angle, 400 corresponds to 360°)
radian	rad	10 <sub>h</sub>	yes	no	<i>Radian</i>
degree	°	41 <sub>h</sub>	yes	no	<i>Degrees</i>
arcminute	'	42 <sub>h</sub>	yes	no	<i>Arcminute</i> (60'=1°)
arcsecond	"	43 <sub>h</sub>	yes	no	<i>Arcsecond</i> (60"=1')
mechanical revolution		B4 <sub>h</sub>	yes	no	<i>Revolution</i>

Name	Unit symbol	Value	6091 <sub>h</sub>	6092 <sub>h</sub>	Description
encoder increment		B5 <sub>h</sub>	no	no	<i>Encoder increments.</i> Dependent on the used sensor (encoder/Hall sensor) and <i>control mode</i> . In <i>open-loop</i> and <i>sensorless mode</i> , the number of pole pairs (2030 <sub>h</sub> ) multiplied by 65536 corresponds to one motor revolution.
step		AC <sub>h</sub>	no	no	<i>Steps.</i> With 2-phase stepper motors, the number of pole pairs (2030 <sub>h</sub> ) multiplied by 4 is equivalent to one revolution. With 3-phase BLDC motors, the number of pole pairs (2030 <sub>h</sub> ) multiplied by 6 is equivalent to one revolution.
electrical pole		C0 <sub>h</sub>	no	no	<i>Electric poles.</i> With a stepper motor that has, e.g., 50 pole pairs (2030 <sub>h</sub> ), the unit corresponds to 1/50 of a revolution.
dimensionless		00 <sub>h</sub>	yes	yes	<i>Dimensionless length unit</i>

Listed in the following table are all supported units for the time and their values for 60A9<sub>h</sub> (Speed unit):

Name	Unit symbol	Value	Description
second	s	03 <sub>h</sub>	<i>Second</i>
minute	min	47 <sub>h</sub>	<i>Minute</i>
hour	h	48 <sub>h</sub>	<i>Hour</i>
day	d	49 <sub>h</sub>	<i>Day</i>
year	a	4A <sub>h</sub>	<i>Year (=365.25 days)</i>

Listed in the following table are the possible exponents and their values for 60A8<sub>h</sub> (Position unit) and 60A9<sub>h</sub> (Speed unit):

Factor	Exponent	Value
10 <sup>6</sup>	6	06 <sub>h</sub>
10 <sup>5</sup>	5	05 <sub>h</sub>
...	...	...
10 <sup>1</sup>	1	01 <sub>h</sub>
10 <sup>0</sup>	0	00 <sub>h</sub>
10 <sup>-1</sup>	-1	FF <sub>h</sub>
...	..	...
10 <sup>-5</sup>	-5	FB <sub>h</sub>
10 <sup>-6</sup>	-6	FA <sub>h</sub>

### 6.3.2 Encoder resolution

The physical resolution for position measurement of the used encoder/sensor is calculated from the encoder increments (60E6<sub>h</sub> (Encoder Increments)) per motor revolutions (60EB<sub>h</sub> (Motor Revolutions)).

### 6.3.3 Gear ratio

The gear ratio is calculated from motor revolutions (60E8<sub>h</sub> (Motor Shaft Revolutions)) per axis rotations (60ED<sub>h</sub> (Driving Shaft Revolutions)).

### 6.3.4 Feed constant

The feed constant is calculated in user-defined position units from the feed ( $60E9_h$  (Feed) per revolution of the output shaft ( $60EE_h$  (Driving Shaft Revolutions)).

The feed constant is useful for specifying the lead screw pitch for a linear axis and is used if the unit is based on length dimensions or if it is dimensionless.

### 6.3.5 Calculation formulas for user units

#### 6.3.5.1 Position unit

Object  $60A8_h$  contains:

- Bits 16 to 23: The position unit (see chapter [Units](#))
- Bits 24 to 31: The exponent of a power of ten (see chapter [Units](#))

31	30	29	28	27	26	25	24	23	22	21	20	19	18	17	16
Factor								Unit							
15	14	13	12	11	10	9	8	7	6	5	4	3	2	1	0
reserved (00h)								reserved (00h)							

#### Example

If  $60A8_h$  is written with the value "FF410000<sub>h</sub>" (bits 16-23=41<sub>h</sub> and bits 24-31=FF<sub>h</sub>), the unit is set to *tenths of degree* (factory setting).

With a relative target position ( $607A_h$ ) of 3600, the motor moves exactly one mechanical revolution, if [Gear ratio](#) is 1:1. The [Feed constant](#) plays no role in this case.

#### Example

If  $60A8_h$  is written with the value "FD010000<sub>h</sub>" (bits 16-23=01<sub>h</sub> and bits 24-31=FD<sub>h</sub>(=-3)), the unit is set to *millimeter*.

With a relative target position ( $607A_h$ ) of 1, the motor moves exactly one mechanical revolution, if [Feed constant](#) and [Gear ratio](#) are 1:1.

If the [Feed constant](#) is set according to the lead screw pitch of a linear axis, the motor turns far enough that a feed of 1 mm is achieved.

Described in chapter [Assignment of the feedbacks to the control loops](#) is how you can determine which encoder/sensor is to be used for position control and measurement.

#### 6.3.5.2 Speed unit

Object  $60A9_h$  contains:

- Bits 8 to 15: The time unit (see chapter [Units](#))
- Bits 16 to 23: The position unit (see chapter [Units](#))
- Bits 24 to 31: The exponent of a power of ten (see chapter [Units](#))

31	30	29	28	27	26	25	24	23	22	21	20	19	18	17	16
Factor								Nominator (Position)							
15	14	13	12	11	10	9	8	7	6	5	4	3	2	1	0
Denominator (Time)								reserved (00h)							

**Example**

If 60A9<sub>h</sub> is written with the value "00B44700<sub>h</sub>" (bits 8-15=00<sub>h</sub>, bits 16-23=B4<sub>h</sub> and bits 24-31=47<sub>h</sub>), the unit is set to *revolutions per minute* (factory setting).

**Example**

If 60A9<sub>h</sub> is written with the value "FD010300<sub>h</sub>" (bits 8-15=FD<sub>h</sub>(=-3), bits 16-23=01<sub>h</sub> and bits 24-31=03<sub>h</sub>), the unit is set to *millimeters per second*.

Described in chapter [Assignment of the feedbacks to the control loops](#) is how you can determine which encoder/sensor is to be used for speed control and measurement.

**NOTICE**

The speed unit in Velocity mode is preset to *revolutions per minute*. You can only set the unit via the 604Ch VI Dimension Factor.

**Conversion factor for the speed unit**

You can set an additional factor for the speed unit. Thus, a unit of, e.g., 1/3 revolutions/minute is possible. The factor  $n$  is calculated from the factor for numerator (6096<sub>h</sub>:01<sub>h</sub>) divided by the factor for denominator (6096<sub>h</sub>:02<sub>h</sub>).

$$n_{\text{velocity}} = \frac{6096_{\text{h}}:01}{6096_{\text{h}}:02}$$

**6.3.5.3 Acceleration unit**

The acceleration unit is speed unit per second.

**Conversion factor for the acceleration unit**

The factor  $n$  for the acceleration unit is calculated from the numerator (6097<sub>h</sub>:01<sub>h</sub>) divided by the denominator (6097<sub>h</sub>:02<sub>h</sub>).

$$n_{\text{acceleration}} = \frac{6097_{\text{h}}:01}{6097_{\text{h}}:02}$$

**6.3.5.4 Jerk unit**

The jerk unit is Acceleration unit per second.

**Conversion factor for jerk**

The factor  $n$  for the jerk is calculated from the numerator (60A2<sub>h</sub>:01<sub>h</sub>) divided by the denominator (60A2<sub>h</sub>:02<sub>h</sub>).

$$n_{\text{jerk}} = \frac{60A2_{\text{h}}:01}{60A2_{\text{h}}:02}$$



## 6.4 Limitation of the range of motion

The digital inputs can be used as limit switches, as is described in chapter [Digital inputs](#), if you activate this function for the inputs. The controller also supports software limit switches.

### 6.4.1 Behavior upon reaching the limit switch

If a limit switch is triggered, the limit switch position is stored internally, bit 7 (*Warning*) in `6041h` (*statusword*) is set and the action stored in object `3701h` is executed (see following table).

Value in object <code>3701<sub>h</sub></code>	Description
-2	No reaction, discard the limit switch position
-1 (factory settings)	No reaction (e. g., to execute a homing operation) except noting the limit switch position
0	Switch off driver without deceleration ramp; drive function blocked – motor can turn freely ( <i>Switch on disabled state</i> )
1	Braking with <i>slow down ramp</i> (deceleration ramp depending on operating mode) and subsequent state change to <i>Switch on disabled</i>
2	Braking with <i>quick stop ramp</i> and subsequent state change to <i>Switch on disabled</i>
5	Braking with <i>slow down ramp</i> (deceleration ramp depending on operating mode) and subsequent state change to <i>Quick stop active</i> ; control does not switch off and the motor remains energized. You can switch back to the <i>Operation enabled</i> state.
6	Braking with <i>quick stop ramp</i> and subsequent state change to <i>Quick Stop Active</i> ; control does not switch off and the motor remains energized. You can switch back to the <i>Operation enabled</i> state.

Continued travel behind the limit switch position is prevented provided the value in `3701h` is not "-1" or "-2". In any case, it is possible to move in the opposite direction.

If the value "-2" is used, bit 7 in `6041h` (*Warning*) is deleted as soon as the limit switches no longer trigger. Otherwise, it is not deleted until the internally noted limit switch position has been returned to.

#### NOTICE



To avoid automatically returning from the *Quick stop active* state to *Operation enabled* when using options "5" or "6" — the quick-stop bit (bit 2) in `6040h` is not used upon triggering of the limit switches — a change of the quick-stop bit from "0" to "1" is expected in order to changed back to the *Operation enabled* state.

### Discarding the limit switch position

#### NOTICE



It is necessary to discard the limit switch positions if both limit switches were actuated simultaneously or the movement range is dynamically limited by a shifting of the limit switches.

To delete internally stored limit switch positions in the event of triggering and to release or clear the limit switches, briefly set object `3701h` to "-2".

If, when using the values "5" or "6" in `3701h`, the state of the *State Machine* is *Quick stop active* and the motor is to remain energized, proceed as follows to avoid an automatic change to the *Switch on disabled* state:

1. Use a rising edge of bit 2 (quick stop) in 6040<sub>h</sub> to switch back to the *Operation enabled* state without, however, starting a movement (set bit 4 in 6040<sub>h</sub> to 0 or target speed or target torque to "0").
2. Set 3701<sub>h</sub> to "-2" .
3. Release the limit switch again.
4. Reset 3701<sub>h</sub> back to "5" or "6".

### 6.4.2 Software limit switches

The controller takes into account software limit switches (607D<sub>h</sub> (Software Position Limit)). Target positions (607A<sub>h</sub>) are limited by 607D<sub>h</sub>; the absolute target position may not be larger than the limits in 607D<sub>h</sub>. If the motor is located outside of the permissible range when setting up the limit switches, only travel commands in the direction of the permissible range are accepted.

## 6.5 Cycle times

The controller operates with a cycle time of 1 ms. This means that data are processed every 1 ms; multiple changes to a value (e.g., value of an object or level at a digital input) within one ms cannot be detected.

The following table includes an overview of the cycle times of the various processes.

Task	Cycle time
Application	1 ms
NanoJ application	1 ms
Current controller	62.5 μs (16 kHz)
Velocity controller	250 μs (4 kHz)
Position controller	1 ms

## 7 Operating modes

### 7.1 Profile Position

#### 7.1.1 Overview

##### 7.1.1.1 Description

*Profile Position Mode* is used to move to positions relative to the last target position or to an absolute position (last reference position). During the movement, the limit values for the speed, starting acceleration/braking deceleration and jerks are taken into account.

##### 7.1.1.2 Activation

To activate the mode, the value "1" must be set in object `6060h` (Modes Of Operation) (see "CiA 402 Power State Machine").

##### 7.1.1.3 Controlword

The following bits in object `6040h` (controlword) have a special function:

- Bit 4 starts a travel command. This is carried out on a transition from "0" to "1". An exception occurs if changing from another operating mode to *profile position*: If bit 4 is already set, it does not need to be set to "0" and then back to "1" in order to start the travel command.
- Bit 5: If this bit is set to "1", a travel command triggered by bit 4 is immediately executed. If it is set to "0", the just executed travel command is completed and only then is the next travel command started.
- Bit 6: With "0", the target position (`607Ah`) is absolute and with "1" the target position is relative. The reference position is dependent on bits 0 and 1 of object `60F2h`.
- Bit 8 (Halt): If this bit is set to "1", the motor stops. On a transition from "1" to "0", the motor accelerates with the set start ramp to the target speed. On a transition from "0" to "1", the motor brakes and comes to a standstill. The braking deceleration is dependent here on the setting of the "Halt Option Code" in object `605Dh`.
- Bit 9 (Change on setpoint): If this bit is set, the speed is not changed until the first target position is reached. This means that, before the first target is reached, no braking is performed, as the motor should not come to a standstill at this position.

Controlword 6040 <sub>h</sub>		
Bit 9	Bit 5	Definition
X	1	The new target position is moved to immediately.
0	0	Positioning is completed before moving to the next target position with the new limits.
1	0	The current target position is only passed through; afterwards, the new target position is moved to with the new values.

For further information, see figure in "Setting travel commands".

#### NOTICE



Bit 9 in the controlword is ignored if the ramp speed is not met at the target point. In this case, the controller would need to reset and take a run-up to reach the preset.

##### 7.1.1.4 Statusword

The following bits in object `6041h` (statusword) have a special function:

- Bit 10 (Target Reached): This bit is set to "1" if the last target was reached and the motor remains within a tolerance window (6067<sub>h</sub>) for a preset time (6068<sub>h</sub>). The bit is also set to "1" if the halt bit (bit 8) in 6040<sub>h</sub> has been set and as soon as the motor is at a standstill.
- Bit 11: Limit exceeded: The demand position is above or below the limit values set in 607D<sub>h</sub>.
- Bit 12 (Set-point acknowledge): This bit confirms receipt of a new and valid set point. It is set and reset in sync with the "New set-point" bit in the controlword.  
 There is an exception in the event that a new movement is started before another one has completed and the next movement is not to occur until after the first one has finished. In this case, the bit is reset if the command was accepted and the controller is ready to execute new travel commands. If a new travel command is sent even though this bit is still set, the newest travel command is ignored.  
 The bit is not set if one of the following conditions is met:
  - The new target position can no longer be reached while adhering to all boundary conditions.
  - A target position was already traveled to and a target position was already specified. A new target position can only be specified after the current positioning has been concluded.
- Bit 13 (Following Error): This bit is set in *closed loop* mode if the following error is greater than the set limits (6065<sub>h</sub> (Following Error Window) and 6066<sub>h</sub> (Following Error Time Out)).

## 7.1.2 Setting travel commands

### 7.1.2.1 Travel command

In object 607A<sub>h</sub> (Target Position), the new target position is specified in user units (see User-defined units). The travel command is then triggered by setting bit 4 in object 6040<sub>h</sub> (controlword). If the target position is valid, the controller responds with bit 12 in object 6041<sub>h</sub> (statusword) and begins the positioning move. As soon as the position is reached, bit 10 in the statusword is set to "1".

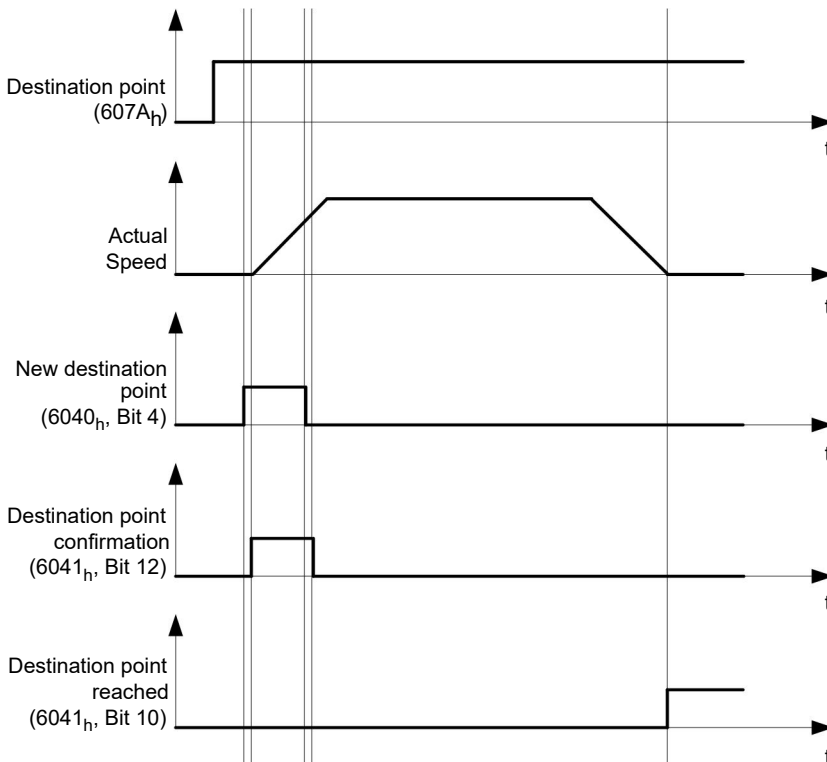

The controller can also reset bit 4 in object 6040<sub>h</sub> (controlword) on its own. This is set with bits 4 and 5 of object 60F2<sub>h</sub>.

### 7.1.2.2 Other travel commands

Bit 12 in object 6041<sub>h</sub> (statusword, set-point acknowledge) changes to "0" if another travel command can be buffered (see time 1 in the following figure). As long as a target position is being moved to, a second target position can be passed to the controller in preparation. All parameters – such as speed, acceleration, braking

deceleration, etc. – can thereby be reset (time 2). If the buffer is empty, the next time can be queued up (time 3).

If the buffer is already full, a new set point is ignored (time 4). If bit 5 in object 6040<sub>h</sub> (controlword, bit: "Change Set-Point Immediately") is set, the controller operates without the buffer; new travel commands are implemented directly (time 5).

**Times**

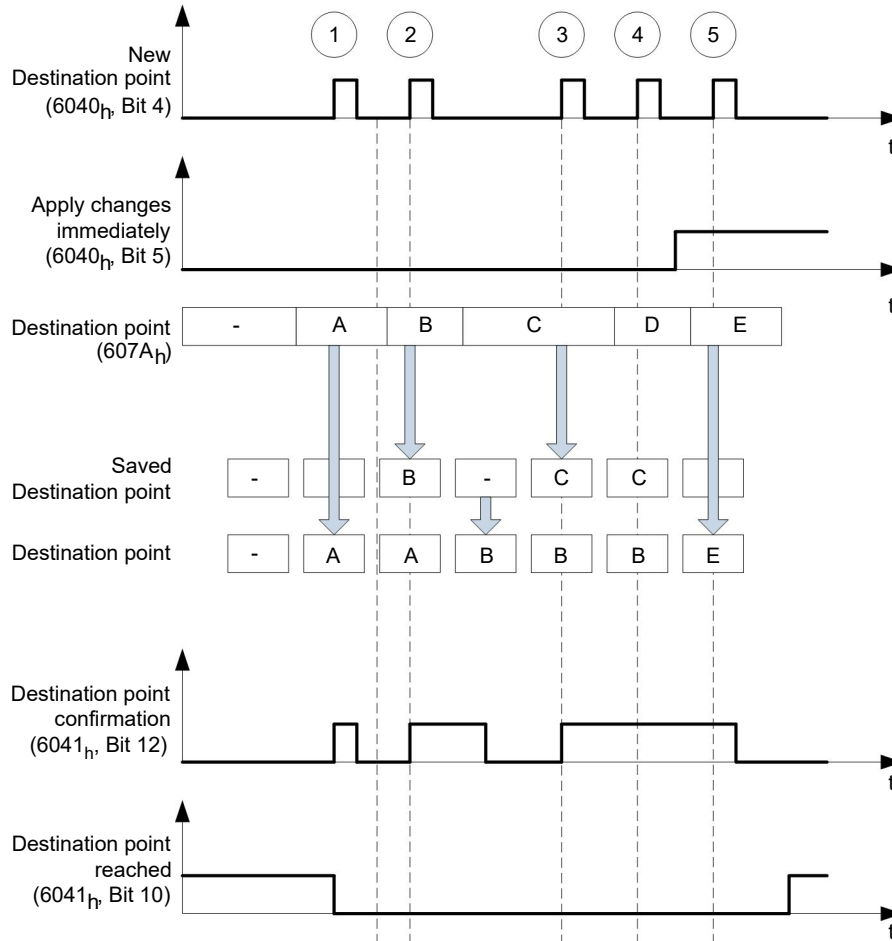

**Transition procedure for second target position**

The following graphic shows the transition procedure for the second target position while moving to the first target position. In this figure, bit 5 of object 6040<sub>h</sub> (controlword) is set to "1"; the new target value is, thus, taken over immediately.

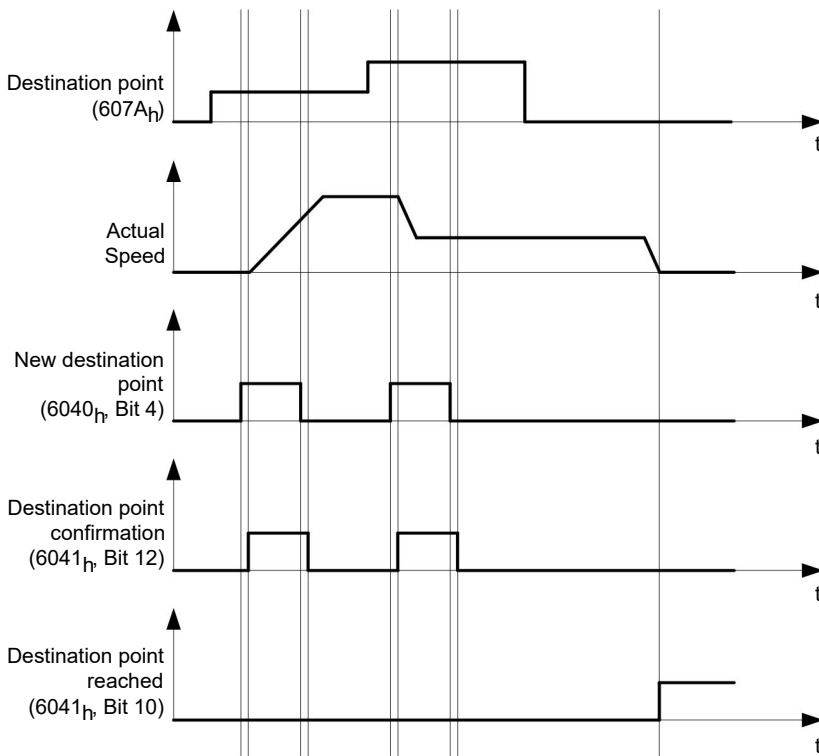

**Possibilities for moving to a target position**

If bit 9 in object 6040<sub>h</sub> (controlword) is equal to "0", the current target position is first moved to completely. In this example, the final speed (6082<sub>h</sub>) of the target position is equal to zero. If bit 9 is set to "1", the profile speed (6081<sub>h</sub>) is maintained until the target position is reached; only then do the new boundary conditions apply.

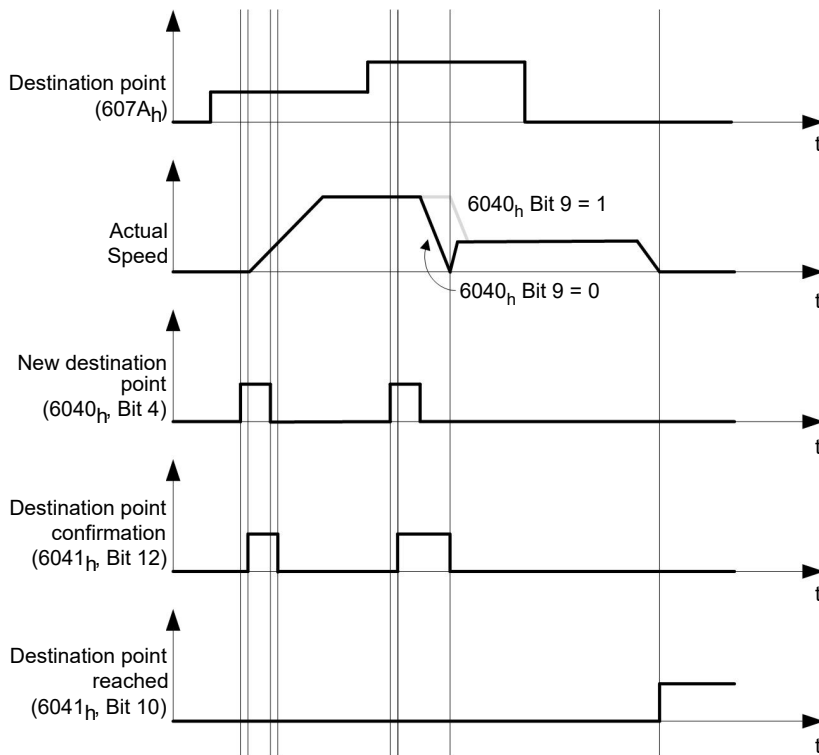

**Possible combinations of travel commands**

To provide a better overview of the travel commands, combinations of travel commands are listed and depicted in this chapter.

The following applies for the figures below:

- A double arrow indicates a new travel command.
- The first travel command at the start is always an absolute travel command to position 1100.
- The second movement is performed at a lower speed so as to present the graphs in a clear manner.

- Change on setpoint ( $6040_h;00$  Bit 5 = 0)
- Move absolute ( $6040_h;00$  Bit 6 = 0)
- Target position: 300

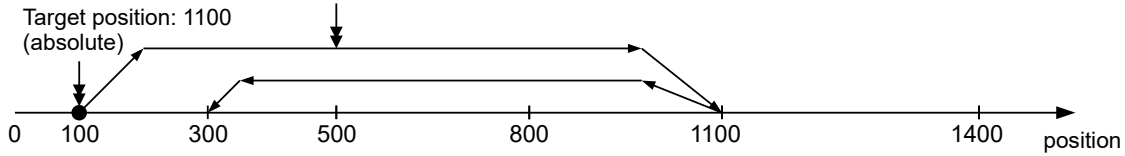

- Relative to the preceding target position ( $60F2_n;00 = 0$ )
- Change on setpoint ( $6040_h;00$  Bit 5 = 0)
- Move relative ( $6040_h;00$  Bit 6 = 1)
- Target position: 300

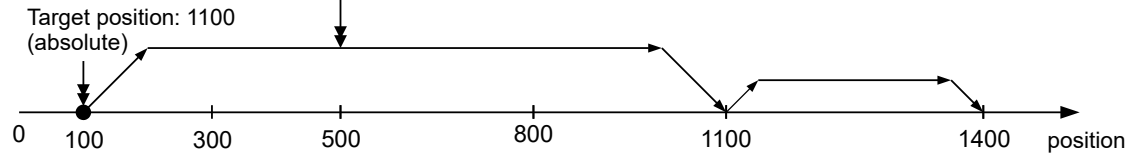

- Change set immediately ( $6040_h;00$  Bit 5 = 1)
- Move absolute ( $6040_h;00$  Bit 6 = 0)
- Target position: 300

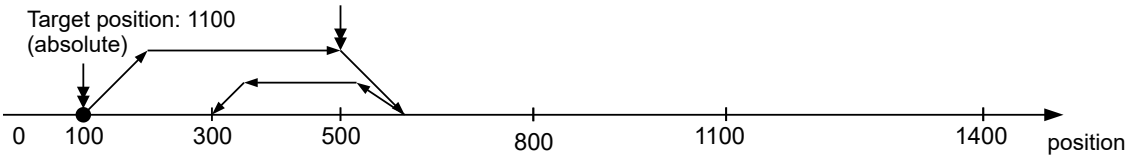

- Relative to the preceding target position ( $60F2_n;00 = 0$ )
- Change set immediately ( $6040_h;00$  Bit 5 = 1)
- Move relative ( $6040_h;00$  Bit 6 = 1)
- Target position: 300

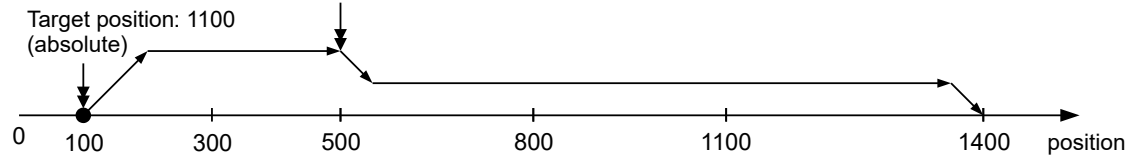

- Change on setpoint (6040<sub>h</sub>:00 Bit 5 = 0)
- Move absolute (6040<sub>h</sub>:00 Bit 6 = 0)
- Target position: 300

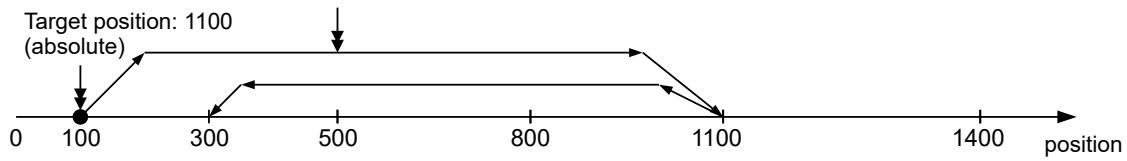

- Relative to the actual position (60F2<sub>h</sub>:00 = 1)
- Change on setpoint (6040<sub>h</sub>:00 Bit 5 = 0)
- Move relative (6040<sub>h</sub>:00 Bit 6 = 1)
- Target position: 300

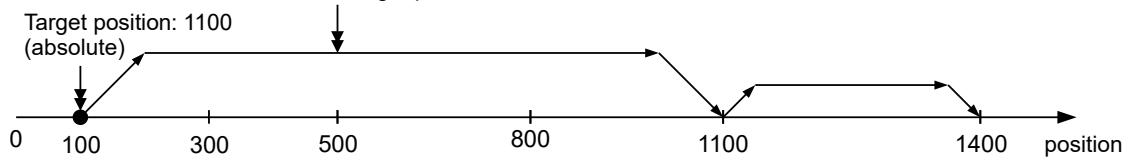

- Change set immediately (6040<sub>h</sub>:00 Bit 5 = 1)
- Move absolute (6040<sub>h</sub>:00 Bit 6 = 0)
- Target position: 300

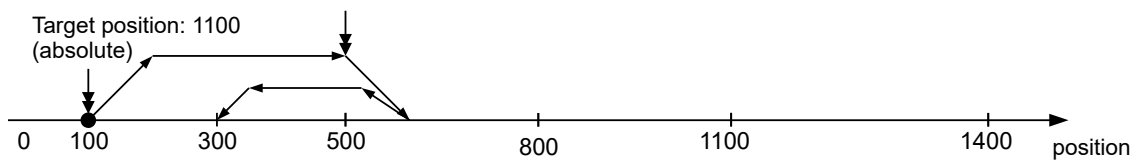

### 7.1.3 Loss of accuracy for relative movements

When linking together relative movements, a loss of accuracy may occur if the final speed is not set to zero. The following graphic illustrates the reason.

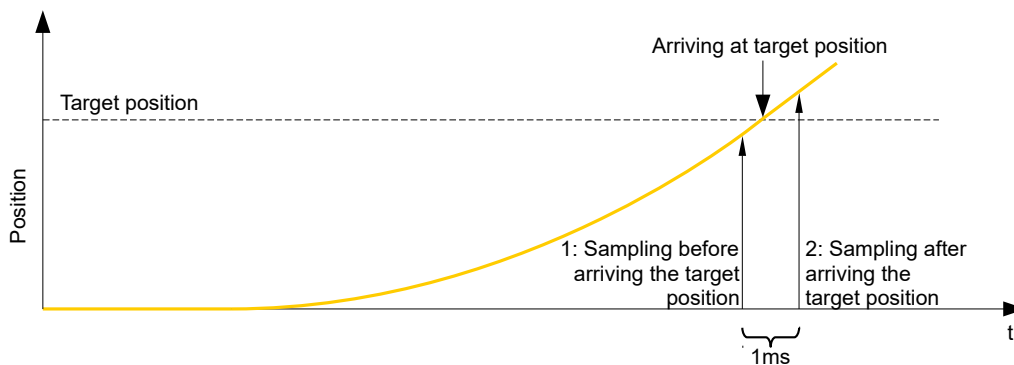

The current position is sampled once per millisecond. It is possible that the target position is reached between two samples. If the final speed is not equal to zero, then, after the target position is reached, the sample is used as an offset as the basis for the subsequent movement. As a result, the subsequent movement may go somewhat farther than expected.



## 7.1.4 Boundary conditions for a positioning move

### 7.1.4.1 Object entries

The boundary conditions for the position that has been moved to can be set in the following entries of the object dictionary:

- **607A<sub>h</sub>**: (Target Position): Planned target position
- **607D<sub>h</sub>**: (Software Position Limit): Definition of the limit stops (see chapter [Software limit switches](#))
- **607C<sub>h</sub>**: (Home Offset): Specifies the difference between the zero position of the controller and the reference point of the machine in user-defined units. (See "[Homing](#)")
- **607B<sub>h</sub>**: (Position Range Limit): Limits of a modulo operation for replicating an endless rotation axis
- **607<sub>h</sub>**: (Polarity): Direction of rotation
- **6081<sub>h</sub>**: (Profile Velocity): Maximum speed with which the position is to be approached
- **6082<sub>h</sub>**: (End Velocity): Speed upon reaching the target position
- **6083<sub>h</sub>**: (Profile Acceleration): Desired starting acceleration
- **6084<sub>h</sub>**: (Profile Deceleration): Desired braking deceleration
- **6085<sub>h</sub>**: (Quick Stop Deceleration): Emergency-stop braking deceleration in case of the "Quick stop active" state of the "CiA 402 Power State Machine"
- **6086<sub>h</sub>**: (Motion Profile Type): Type of ramp to be traveled; if the value is "0", the jerk is not limited; if the value is "3", the values of 60A4<sub>h</sub>:1<sub>h</sub>–4<sub>h</sub> are set as limits for the jerk.
- **60C5<sub>h</sub>**: (Max Acceleration): The maximum acceleration that may not be exceeded when moving to the end position
- **60C6<sub>h</sub>**: (Max Deceleration): The maximum braking deceleration that may not be exceeded when moving to the end position
- **60A4<sub>h</sub>**: (Profile Jerk), subindex 01<sub>h</sub> to 04<sub>h</sub>: Objects for specifying the limit values for the jerk.
- The speed is limited by **607E<sub>h</sub>** (Max Profile Velocity) and **6080<sub>h</sub>** (Max Motor Speed); the smaller value is used as the limit.
- **60F2<sub>h</sub>**: (Positioning Option Code): Defines the positioning behavior

### 7.1.4.2 Objects for the positioning move

The following graphic shows the objects involved in the boundary conditions of the positioning move.

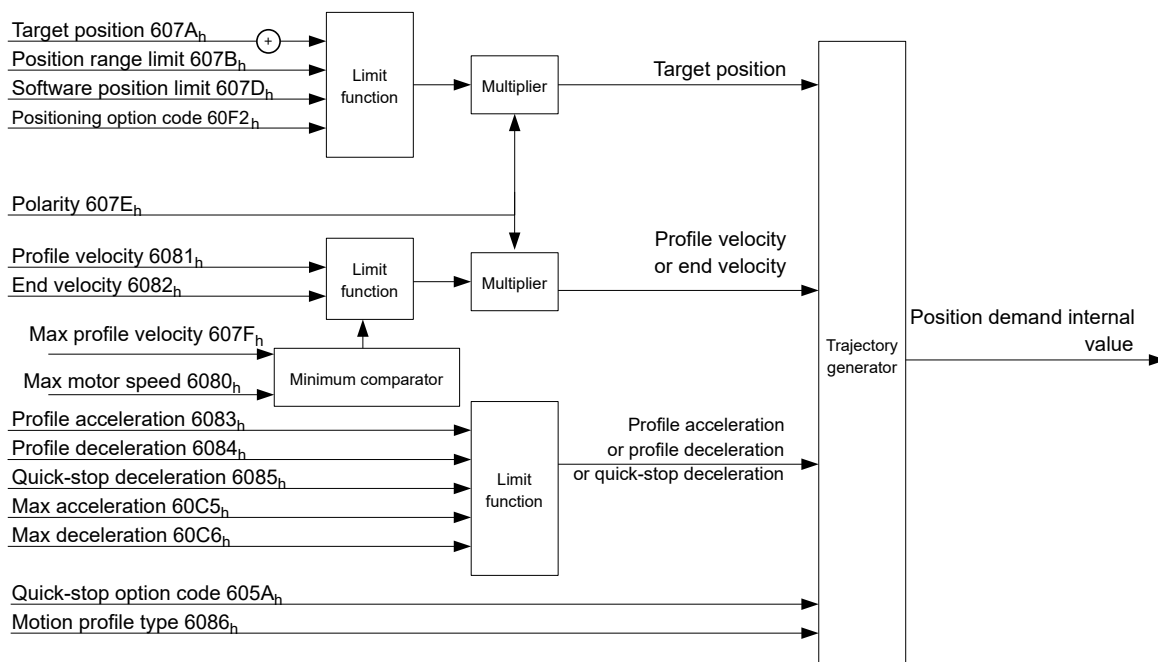

### 7.1.4.3 Parameters for the target position

The following graphic shows an overview of the parameters that are used for moving to a target position (figure not to scale).

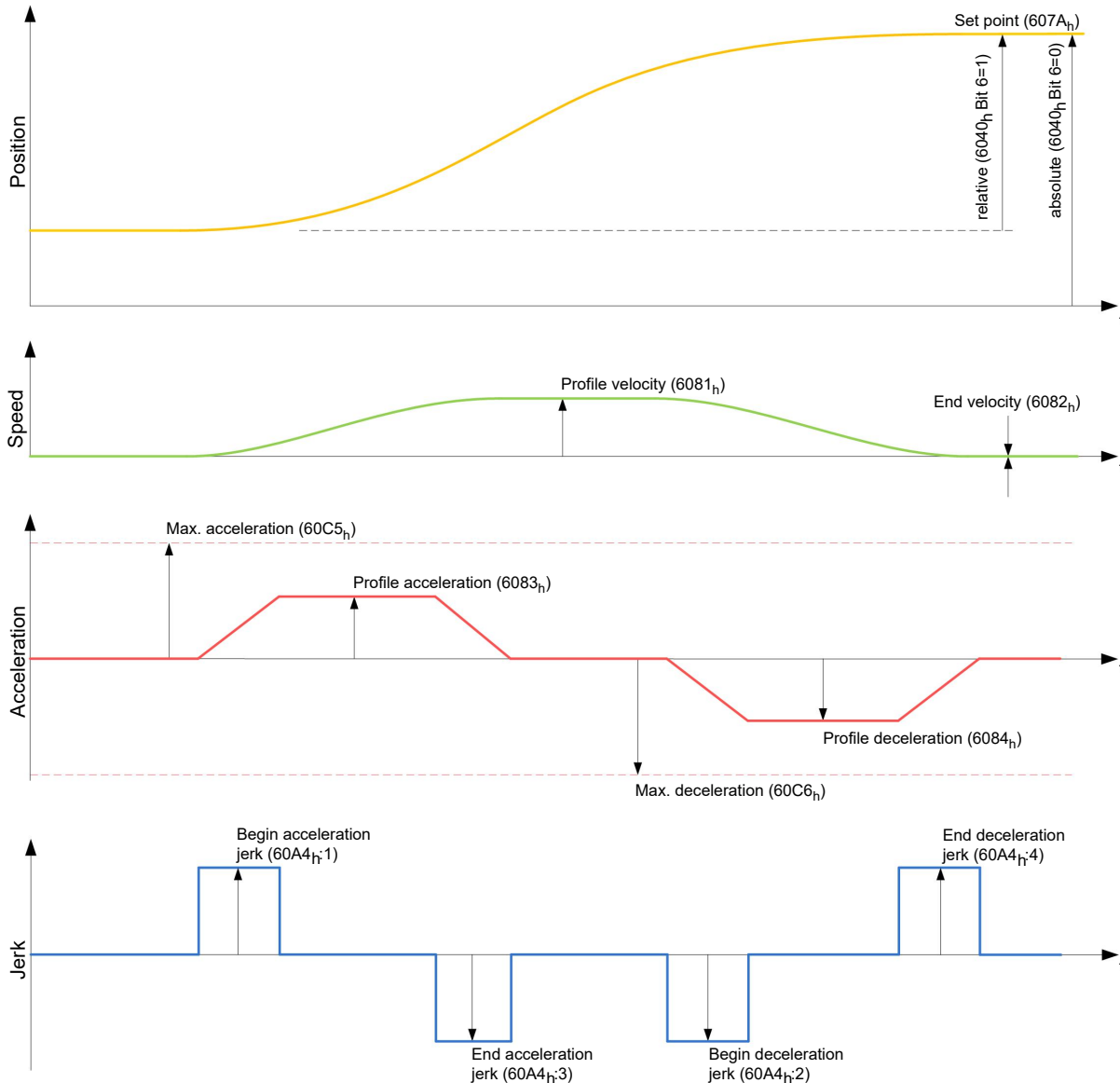

### 7.1.5 Jerk-limited mode and non-jerk-limited mode

#### 7.1.5.1 Description

A distinction is made between the "jerk-limited" and "non-jerk-limited" modes.

#### 7.1.5.2 Jerk-limited mode

Jerk-limited positioning can be achieved by setting object 6086<sub>h</sub> to "3". The entries for the jerks in subindices :1<sub>h</sub>–4<sub>h</sub> of object 60A4 thereby become valid.

#### 7.1.5.3 Non-jerk-limited mode

A "non-jerk-limited" ramp is traveled if the entry in object 6086<sub>h</sub> is set to "0" (default setting).

## 7.2 Velocity

### 7.2.1 Description

This mode operates the motor at a preset target speed, similar to a frequency inverter. Unlike the *profile velocity mode*, this mode does not permit the selection of jerk-limited ramps.

### 7.2.2 Activation

To activate the mode, the value "2" must be set in object 6060<sub>h</sub> (Modes Of Operation) (see "CiA 402 Power State Machine").

### 7.2.3 Controlword

The following bits in object 6040<sub>h</sub> (controlword) have a special function:

- Bit 8 (Halt): If this bit is set to "1", the motor stops. On a transition from "1" to "0", the motor accelerates with the acceleration ramp to the target speed. On a transition from "0" to "1", the motor brakes according to the deceleration ramp and comes to a standstill.

### 7.2.4 Statusword

The following bits in object 6041<sub>h</sub> (statusword) have a special function:

- Bit 11: Limit exceeded: The target speed is above or below the set limit values.

### 7.2.5 Object entries

The following objects are necessary for controlling this mode:

- 604C<sub>h</sub> (Dimension Factor):  
The unit for speed values is defined here for the following objects.  
Subindex 1 contains the denominator (multiplier) and subindex 2 contains the numerator (divisor) with which the internal speed values are converted to revolutions per minute. If, for example, subindex 1 is set to the value "60" and subindex 2 is set to the value "1", the speed is specified in revolutions per second (60 revolutions per 1 minute).
- 6042<sub>h</sub>: Target Velocity.  
The target speed is set here in user-defined units.
- 6048<sub>h</sub>: Velocity Acceleration  
This object defines the acceleration. Subindex 1 contains the change in speed, subindex 2 the corresponding time in seconds. Both together are used to calculate the acceleration:

$$\text{VL velocity acceleration} = \frac{\text{Delta speed (6048}_{h}:1)}{\text{Delta time (6048}_{h}:2)}$$

- 6049<sub>h</sub> (Velocity Deceleration):  
This object defines the deceleration (deceleration ramp). The subindices here are arranged as described in object 6048<sub>h</sub>; the change in speed is to be specified with positive sign.
- 6046<sub>h</sub> (Velocity Min Max Amount):  
The limitations of the target speeds are specified in this object.  
The minimum speed is set in 6046<sub>h</sub>:1<sub>h</sub>. If the target speed (6042<sub>h</sub>) falls below the minimum speed, the value is limited to the minimum speed 6046<sub>h</sub>:1<sub>h</sub>.  
The maximum speed is set in 6046<sub>h</sub>:2<sub>h</sub>. If the target speed (6042<sub>h</sub>) exceeds the maximum speed, the value is limited to the maximum speed 6046<sub>h</sub>:2<sub>h</sub>.
- 604A<sub>h</sub> (Velocity Quick Stop):  
This object can be used to set the quick-stop ramp. Subindices 1 and 2 are identical to those described for object 6048<sub>h</sub>.

The following objects can be used to check the function:

- 6043<sub>h</sub> (VI Velocity Demand)
- 6044<sub>h</sub> (VI Velocity Actual Value)

### 7.2.5.1 Speeds in Velocity Mode

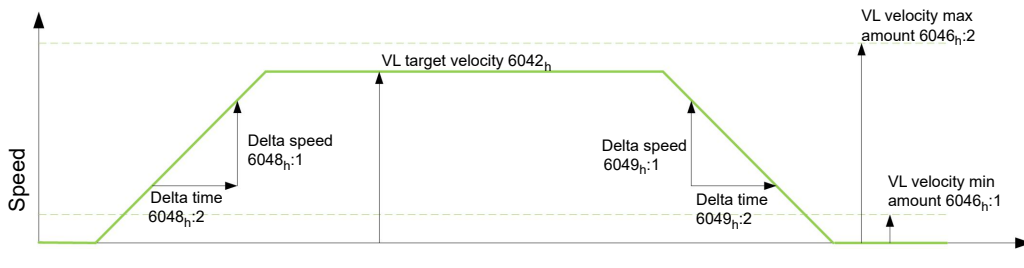

### 7.2.5.2 Objects for Velocity Mode

The ramp generator follows the target speed, remaining within the set speed and acceleration limits. As long as a limit is active, bit 11 in object 6041<sub>h</sub> is set (internal limit active).

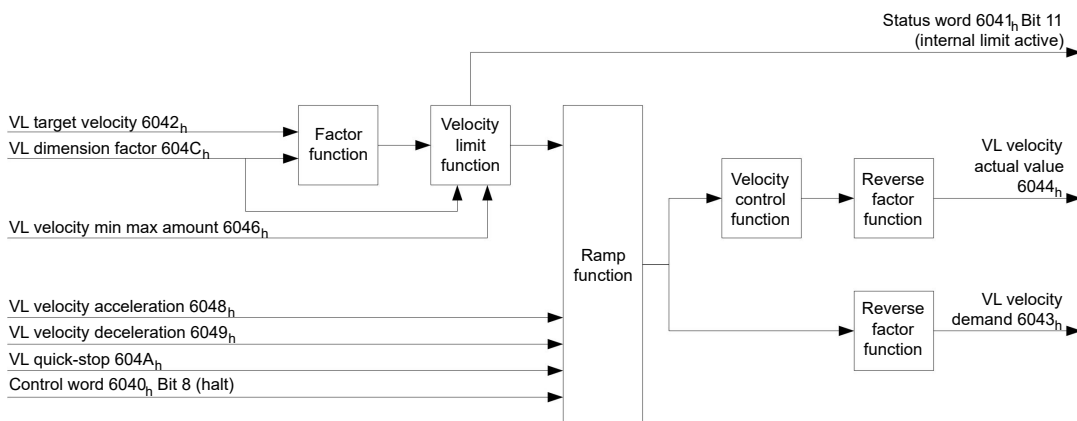

## 7.3 Profile Velocity

### 7.3.1 Description

This mode operates the motor in Velocity Mode with extended (jerk-limited) ramps. Unlike *Velocity Mode* (see "Velocity"), the statusword is used in this mode to indicate whether the target speed is reached.

### 7.3.2 Activation

To activate the mode, the value "3" must be set in object 6060<sub>h</sub> (Modes Of Operation) (see "CiA 402 Power State Machine").

### 7.3.3 Controlword

The following bits in object 6040<sub>h</sub> (controlword) have a special function:

- Bit 8 (Halt): If this bit is set to "1", the motor stops. On a transition from "1" to "0", the motor accelerates with the set start ramp to the target speed. On a transition from "0" to "1", the motor brakes and comes to a standstill.

### 7.3.4 Statusword

The following bits in object 6041<sub>h</sub> (statusword) have a special function:

- Bit 10 (target speed reached; Target Reached): In combination with bit 8 in the controlword, this bit specifies whether the target speed is reached, if braking is taking place or if the motor is at a standstill (see table).

6041 <sub>h</sub> Bit 10	6040 <sub>h</sub> Bit 8	Description
0	0	Target speed not reached
0	1	Axis braking
1	0	Target speed within target window (defined in 606D <sub>h</sub> and 606E <sub>h</sub> )
1	1	Axis speed is 0

- Bit 12: This bit indicates whether the actual speed is zero.  
If the actual speed is greater than the value in 606F<sub>h</sub>(Velocity Threshold) for a time of 6070<sub>h</sub>(Velocity Threshold Time), this bit has the value "0". The bit otherwise remains set to "1".
- Bit 13 (Deviation Error): This bit is set in *closed loop* mode if the slippage error is greater than the set limits (60F8<sub>h</sub> Max Slippage and 203F<sub>h</sub> Max Slippage Time Out).

### 7.3.5 Object entries

The following objects are necessary for controlling this mode:

- 606B<sub>h</sub> (Velocity Demand Value):  
This object contains the output of the ramp generator, which simultaneously serves as the preset value for the velocity controller.
- 606C<sub>h</sub> (Velocity Actual Value):  
Indicates the current actual speed.
- 606D<sub>h</sub> (Velocity Window):  
This value specifies by how much the actual speed may vary from the set speed for bit 10 (target speed reached; Target Reached") in object 6041<sub>h</sub> (statusword) to be set to "1".
- 606E<sub>h</sub> (Velocity Window Time):  
This object specifies how long the actual speed and the set speed must be close to one another (see 606D<sub>h</sub> "Velocity Window") for bit 10 "Target speed reached" in object 6041<sub>h</sub> (statusword) to be set to "1".
- 607E<sub>h</sub> (Polarity):  
If bit 6 is set to "1" here, the sign of the target speed is reversed.
- 6083<sub>h</sub> (Profile acceleration):  
Sets the value for the acceleration ramp.
- 6084<sub>h</sub> (Profile Deceleration):  
Sets the value for the deceleration ramp.
- 6085<sub>h</sub> (Quick Stop Deceleration):  
Sets the value for the deceleration ramp for rapid braking.
- 6086<sub>h</sub> (Motion Profile Type):  
The ramp type can be selected here ("0" = trapezoidal ramp, "3" = jerk-limited ramp).
- 60FF<sub>h</sub> (Target Velocity):  
Specifies the target speed that is to be reached.
- The speed is limited by 607E<sub>h</sub> (Max Profile Velocity) and 6080<sub>h</sub> (Max Motor Speed); the smaller value is used as the limit.

### 7.3.5.1 Objects in Profile Velocity Mode

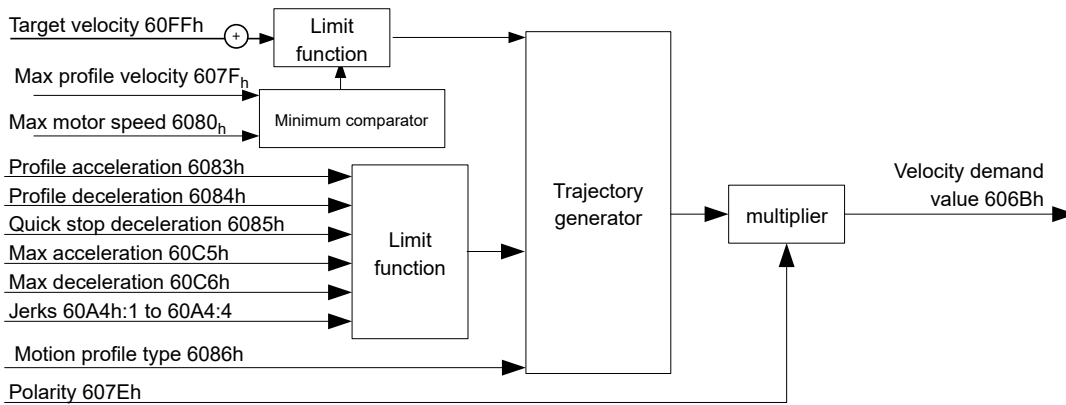

### 7.3.5.2 Activation

After the mode is selected in object 6060<sub>h</sub> (Modes Of Operation) and the "Power State machine" (see "CiA 402 Power State Machine") is switched to *Operation enabled*, the motor is accelerated to the target speed in object 60FF<sub>h</sub> (see following figures). The speed and acceleration values are taken into account here; for jerk-limited ramps, the jerk-limit values are also taken into account.

### 7.3.5.3 Limitations in the jerk-limited case

The following figure shows the adjustable limits in the jerk-limited case (6086<sub>h</sub> = 3).

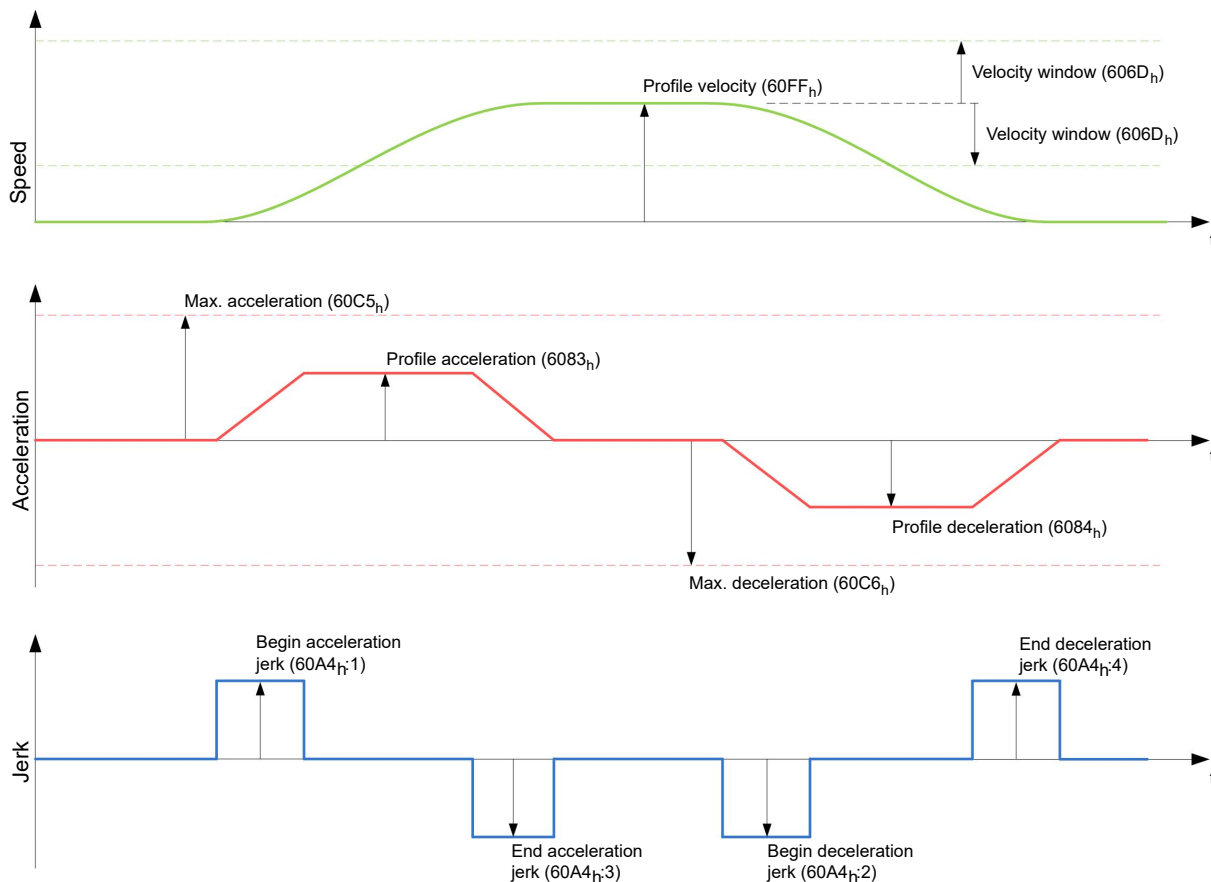

### 7.3.5.4 Limitations in the trapezoidal case

This figure shows the adjustable limitations for the trapezoidal case ( $6086_h = 0$ ).

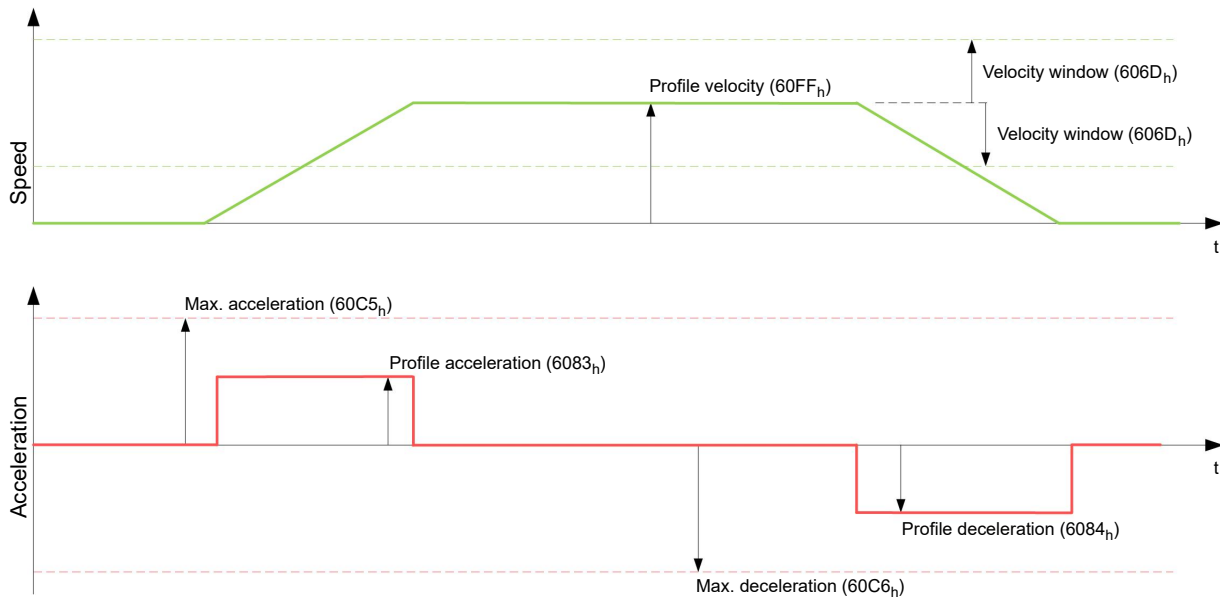

## 7.4 Profile Torque

### 7.4.1 Description

In this mode, the torque is preset as a set value and reached via a ramp function.



#### NOTICE

This mode only functions if closed loop is activated, see also Commissioning Closed Loop.

### 7.4.2 Activation

To activate the mode, the value "4" must be set in object  $6060_h$  (Modes Of Operation) (see "CiA 402 Power State Machine").

### 7.4.3 Controlword

The following bits in object  $6040_h$  (controlword) have a special function:

- Bit 8 (Halt): If this bit is set to "1", the motor stops. If this bit is set from "1" to "0", the motor is started up according to the presets. When setting from "0" to "1", the motor is again brought to a standstill, taking the preset values into consideration.

### 7.4.4 Statusword

The following bits in object  $6041_h$  (statusword) have a special function:

- Bit 10 (Target Reached): In combination with bit 8 of object  $6040_h$  (controlword), this bit indicates whether the specified torque is reached (see following table). The target is considered having been met if the current torque ( $6077_h$  Torque Actual Value) is within a tolerance window ( $203D_h$  Torque Window) for a specified time ( $203E_h$  Torque Window Time Out).

$6040_h$ Bit 8	$6041_h$ Bit 10	Description
0	0	Specified torque not reached

6040 <sub>h</sub> Bit 8	6041 <sub>h</sub> Bit 10	Description
0	1	Specified torque reached
1	0	Axis brakes
1	1	Axis speed is 0

- Bit 11: Limit exceeded: The target torque (6071<sub>h</sub>) exceeds the maximum torque entered in 6072<sub>h</sub>.

### 7.4.5 Object entries

All values of the following entries in the object dictionary are to be specified as a thousandth of the maximum torque, which corresponds to the rated current (203B<sub>h</sub>:01<sub>h</sub>). This includes the objects:

- 6071<sub>h</sub> (Target Torque): Target torque
- 6072<sub>h</sub> (Max Torque): Maximum torque during the entire ramp (accelerate, maintain torque, decelerate)
- 6073<sub>h</sub> (Max Current): Maximum current. The minimum of 6073<sub>h</sub> and 6072<sub>h</sub> is used as limit for the torque in 6071<sub>h</sub>.
- 6074<sub>h</sub> (Torque Demand): Current output value of the ramp generator (torque) for the controller
- 6087<sub>h</sub> (Torque Slope): Max. change in torque per second

**NOTICE**



These values are not limited to 100% of the rated current (203B<sub>h</sub>:01<sub>h</sub>). Torque values greater than the rated torque (generated from the rated current) can be achieved if the maximum duration (203B<sub>h</sub>:02<sub>h</sub>) of the maximum current (6073<sub>h</sub>) is set (see [I2t Motor overload protection](#)). All torque objects are limited by the maximum motor current (2031<sub>h</sub>).

The following objects are also needed for this operating mode:

- 3202<sub>h</sub> Bit 5 (Motor Drive Submode Select):  
If this bit is set to "0", the drive controller is operated in the torque-limited Velocity Mode, i.e., the maximum speed can be limited in object 6080<sub>h</sub> and the controller can operate in field weakening mode.  
If this bit is set to "1", the controller operates in the ("Real") Torque Mode; the maximum speed cannot be limited here and field weakening mode is not possible.

#### 7.4.5.1 Objects of the ramp generator

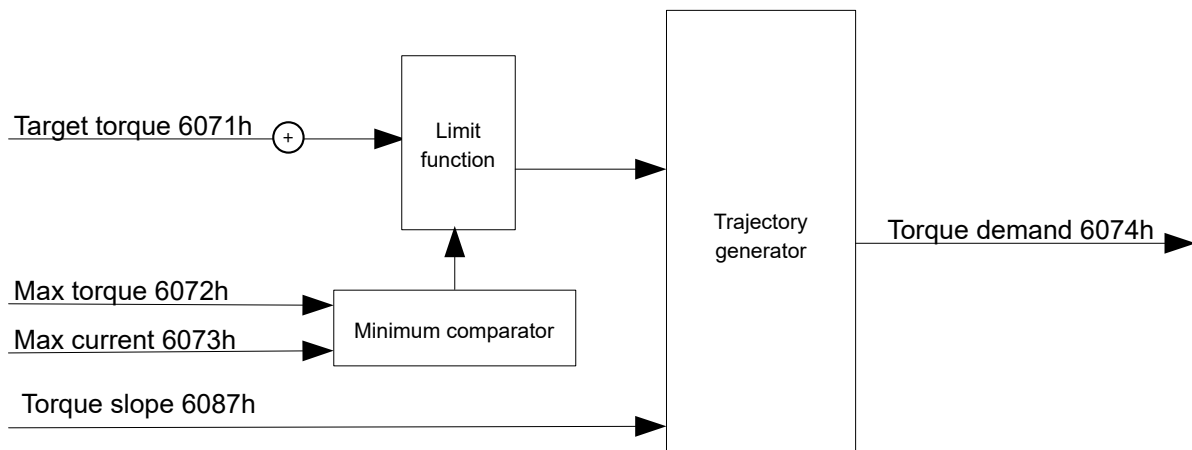



### 7.4.5.2 Torque curve

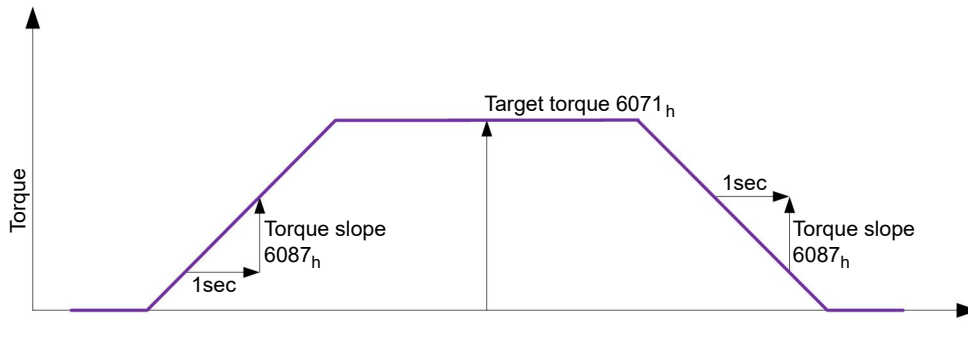

## 7.5 Homing

### 7.5.1 Overview

#### 7.5.1.1 Description

The purpose of the homing method is to align the position zero point of the controller with an encoder index or position switch.

#### 7.5.1.2 Activation

To activate the mode, the value "6" must be set in object 6060<sub>h</sub> (Modes Of Operation) (see "[CiA 402 Power State Machine](#)").

#### TIP



If home switches and/or limit switches are used, these special functions must first be activated in the I/O configuration (see "[Digital inputs and outputs](#)").

To use the limit switch, you must also set object 3701<sub>h</sub> to "-1" (factory setting) to prevent blocking the further travel of the motor.

#### 7.5.1.3 Controlword

The following bits in object 6040<sub>h</sub> (controlword) have a special function:

- Bit 4: If the bit is set to "1", referencing is started. This is performed until either the reference position is reached or bit 4 is reset to "0".

#### 7.5.1.4 Statusword

The following bits in object 6041<sub>h</sub> (statusword) have a special function:

Bit 13	Bit 12	Bit 10	Description
0	0	0	Homing is performed
0	0	1	Homing is interrupted or not started
0	1	0	Homing has been performed since the last restart but target is not currently reached
0	1	1	Homing completed
1	0	0	Error during homing, motor still turning
1	0	1	Error during homing, motor at standstill

### NOTICE



Bit 12 in *Homing* mode is set to 1 after the first fully completed homing operation since the restart. It is only reset to 0

- during all subsequent homing operations
- in the event of an error during a homing operation (permanently deleted until a new homing operation is fully completed).

#### 7.5.1.5 Object entries

The following objects are necessary for controlling this mode:

- $607C_h$  (Home Offset): Specifies the difference between the zero position of the controller and the reference point of the machine in user-defined units.
- $6098_h$  (Homing Method): Method to be used for referencing (see "Homing method")
- $6099_h:01_h$  (Speed During Search For Switch): Speed for the search of the switch
- $6099_h:02_h$  (Speed During Search For Zero): Speed for the search of the index
- $6080_h$  (Max Motor Speed): Maximum speed
- $609A_h$  (Homing Acceleration): Starting acceleration and braking deceleration for homing
- $203A_h:01_h$  (Minimum Current For Block Detection): Minimum current threshold which, if exceeded, is to detect the blocking of the motor at a block.
- $203A_h:02_h$  (Period Of Blocking): Specifies the time in ms that the motor is to continue to run against the block after block detection.

#### Homing speeds

The figure shows the homing speeds using method 4 as an example:

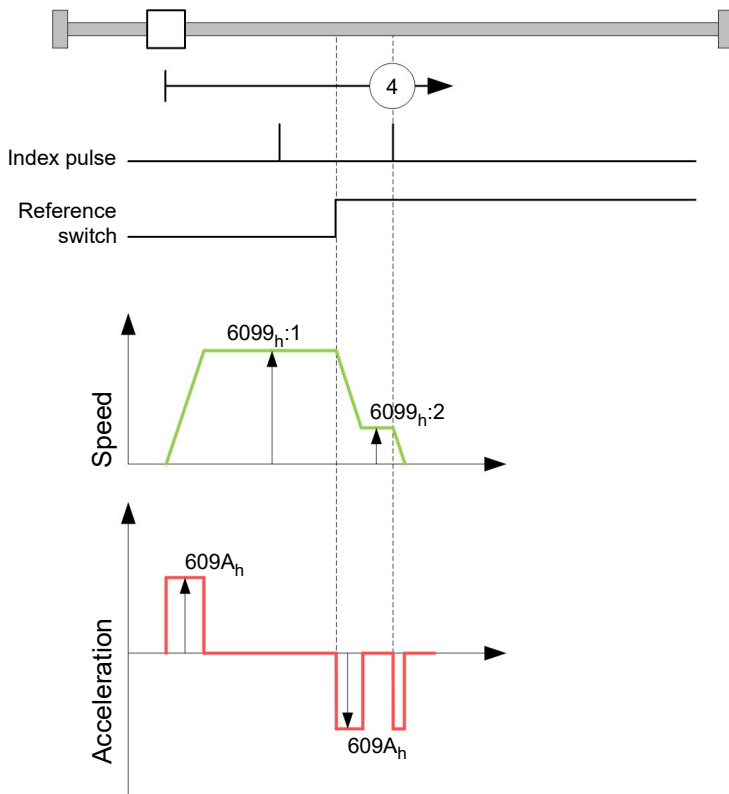

## 7.5.2 Homing method

### 7.5.2.1 Description

The homing method is written as a number in object  $6098_h$  and decides whether, on a switch edge (rising/falling), a current threshold for block detection or an index pulse is referenced or in which direction homing starts. Methods that use the index pulse of the encoder lie in the number range 1 to 14, 33 and 34. Methods that do not use the index pulse of the encoder lie between 17 and 30, but are identical to methods 1 to 14 with respect to the travel profiles. These number are shown in circles in the following figures. Methods for which no limit switches are used and, instead, travel against a block is to be detected, a minus must be placed before the method number when making the call.

In the following graphics, the negative movement direction is to the left. The *limit switch* is located before the respective mechanical block; the *home switch* is located between the two limit switches. The index pulses come from the connected encoder.

For methods that use homing on block, the same figures apply as for the methods with limit switch. Because nothing is different aside from the missing limit switches, the same figures are used. For the figures here, the limit switches must be replaced with a mechanical block.

### 7.5.2.2 Homing on block

Homing on block currently only functions in *closed loop* mode.

"Homing on block" functions like every homing method with the difference that instead of a limit switch, a block (limit stop) is used for positioning. Two settings are to be made here:

1. Current level: In object  $203A_h:01$ , the current level is defined above which movement against the block is detected.
2. Blocking duration: In object  $203A_h:02$ , the duration during which the motor moves against the block is set.

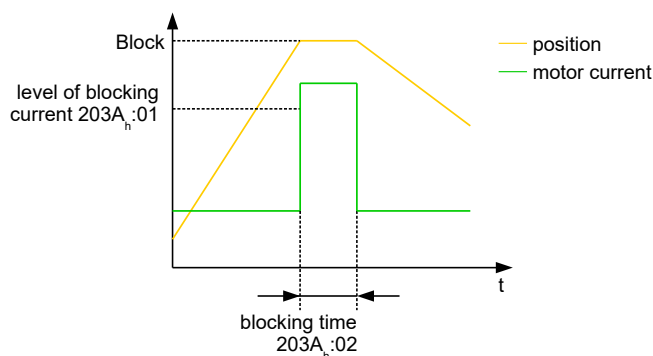

### 7.5.2.3 Overview of methods

Methods 1 to 14 as well as 33 and 34 use the index pulse of the encoder.

Methods 17 to 32 are identical to methods 1 to 14 with the difference that only limit or home switches are used for referencing and not the index pulse.

- Methods 1 to 14 use an index pulse.
- Methods 17 to 30 do not use an index pulse.
- Methods 33 and 34 reference only to the next index pulse.
- Method 35 references to the current position.

The following methods can be used for homing on block:

- Methods -1 to -2 and -7 to -14 contain an index pulse
- Methods -17 to -18 and -23 to -30 have no index pulse

### 7.5.2.4 Methods 1 and 2

Reference to limit switches and index pulse.

Method 1 references to negative limit switch and index pulse:

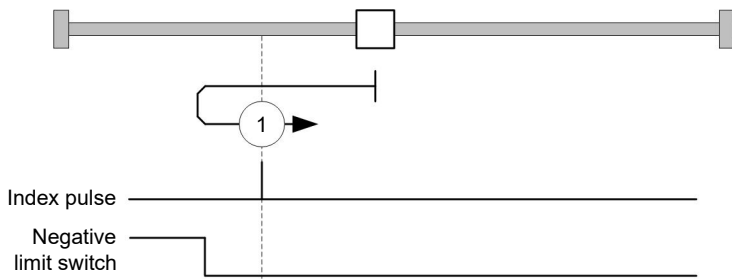

Method 2 references to positive limit switch and index pulse:

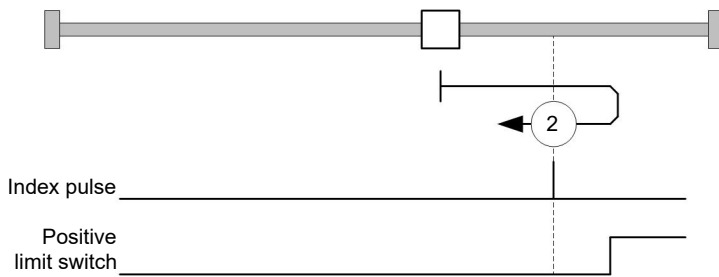

### 7.5.2.5 Methods 3 to 6

Reference to the switching edge of the home switch and index pulse.

With methods 3 and 4, the left switching edge of the home switch is used as reference:

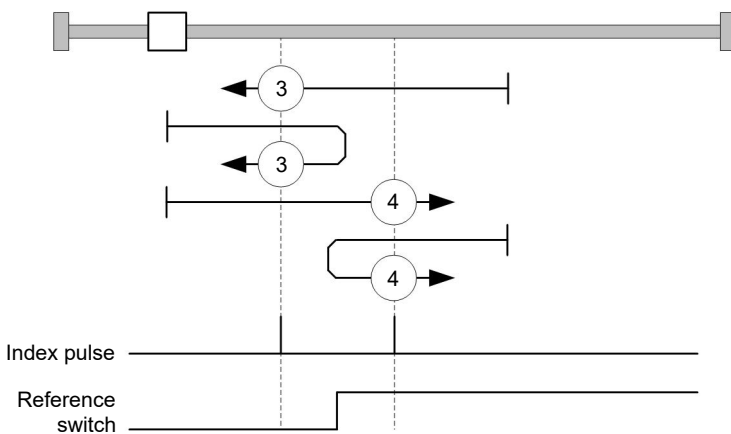

With methods 5 and 6, the right switching edge of the home switch is used as reference:

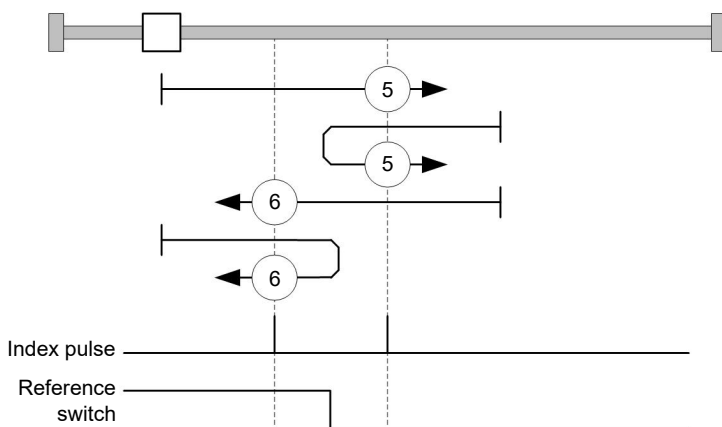

### 7.5.2.6 Methods 7 to 14

Reference to the home switch and index pulse (with limit switches).

With these methods, the current position relative to the home switch is not important. With method 10, for example, referencing is always performed to the index pulse to the right of the right edge of the home switch.

Methods 7 to 10 take the positive limit switch into account:

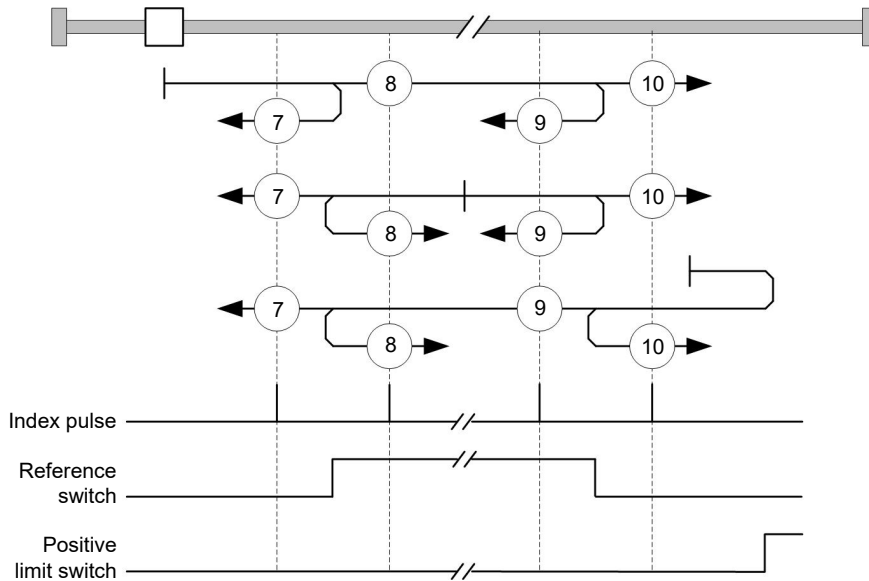

Methods 11 to 14 take the negative limit switch into account:

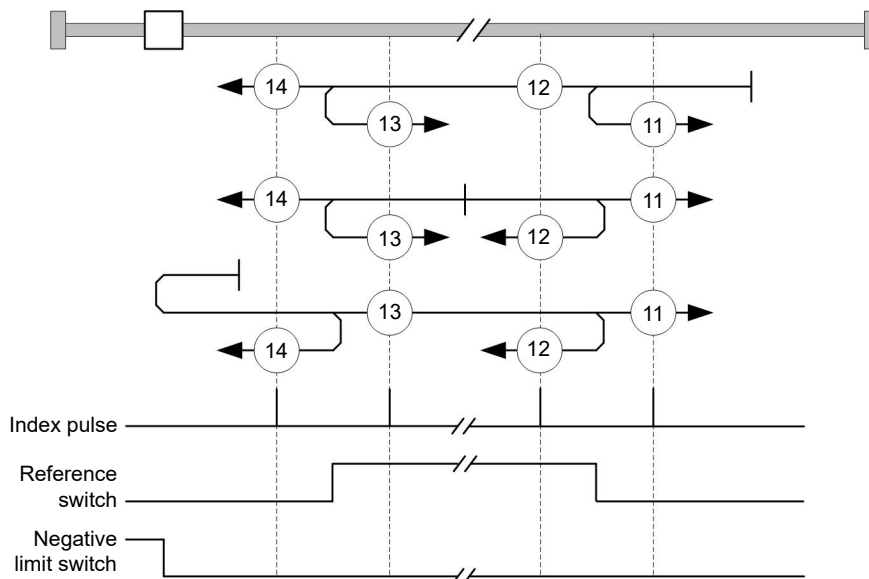

### 7.5.2.7 Methods 17 and 18

Reference to the limit switch without the index pulse.

Method 17 references to the negative limit switch:

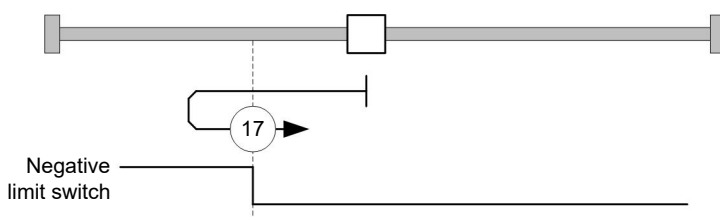

Method 18 references to the positive limit switch:

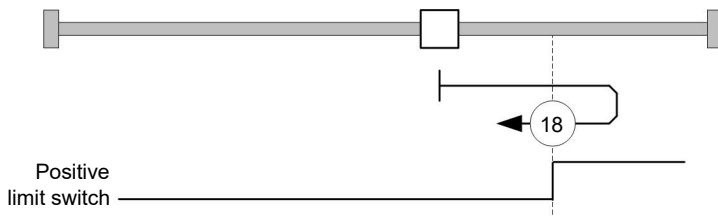

**7.5.2.8 Methods 19 to 22**

Reference to the switching edge of the home switch without the index pulse.

With methods 19 and 20 (equivalent to methods 3 and 4), the left switching edge of the home switch is used as reference:

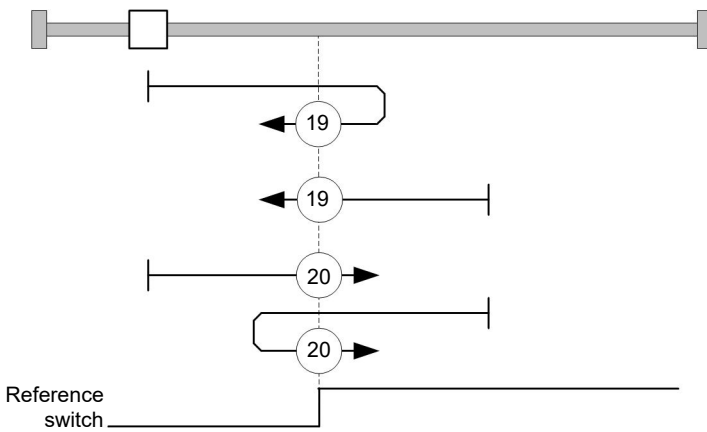

With methods 21 and 22 (equivalent to methods 5 and 6), the right switching edge of the home switch is used as reference:

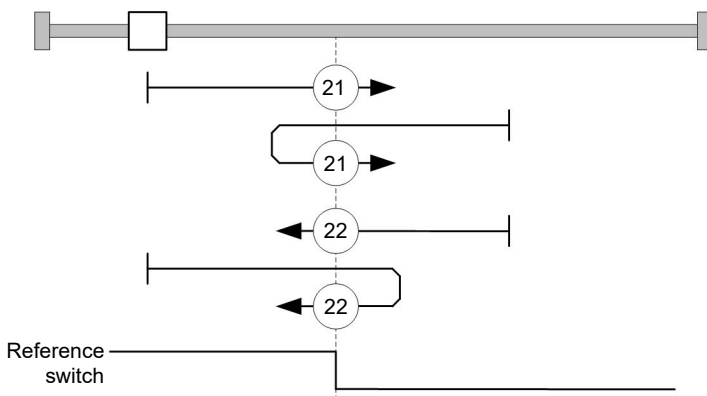

**7.5.2.9 Methods 23 to 30**

Reference to the home switch without the index pulse (with limit switches).

With these methods, the current position relative to the home switch is not important. With method 26, for example, referencing is always performed to the index pulse to the right of the right edge of the home switch.

Methods 23 to 26 take the positive home switch into account:

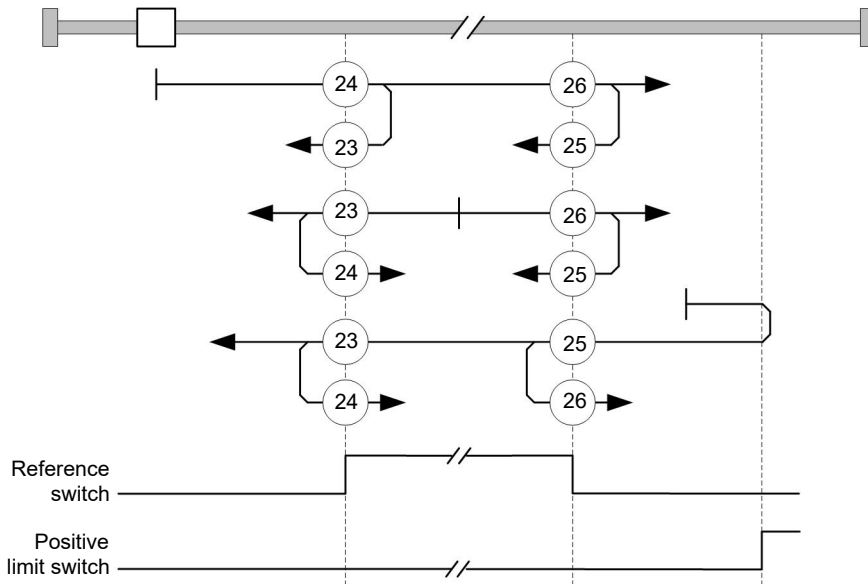

Methods 27 to 30 take the negative home switch into account:

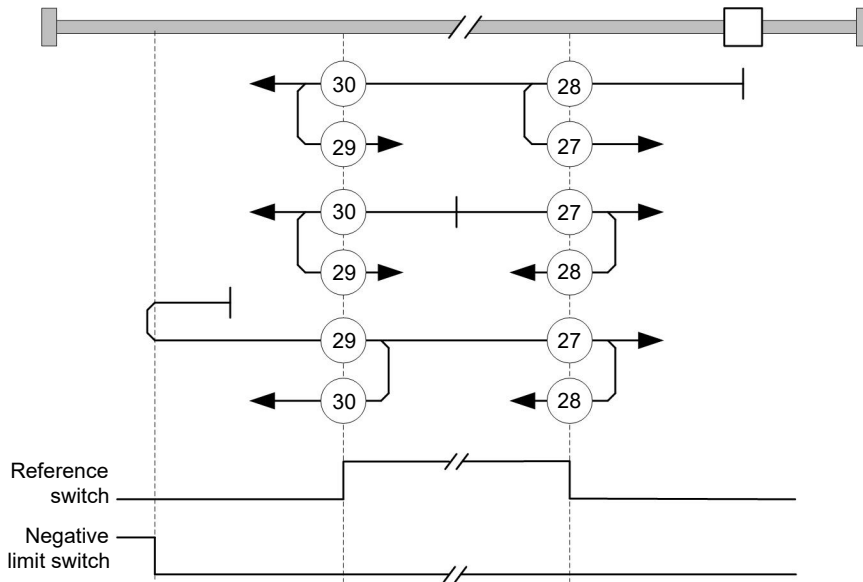

### 7.5.2.10 Methods 33 and 34

Reference to the next index pulse.

With these methods referencing is only performed to the respective subsequent index pulse:

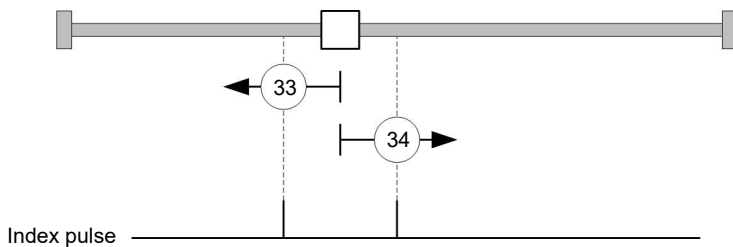

### 7.5.2.11 Method 35

References to the current position.

### NOTICE



For homing mode 35, it is not necessary to switch the CiA 402 Power State Machine to the "Operation enabled" state. When energizing the motor windings in *open loop* mode, it is thereby possible to prevent the current position from not being exactly 0 after Homing Mode 35.

## 7.6 Interpolated Position Mode

### 7.6.1 Overview

#### 7.6.1.1 Description

*Interpolated position mode* is used to synchronize multiple axes. For this purpose, a higher-level controller performs the ramp and path calculation and passes the respective demand position, at which the axis is to be located at a certain time, to the controller. The controller interpolates between these intermediate position points.

#### 7.6.1.2 Synchronization with the SYNC object

For interpolated position mode, it is necessary that the controller synchronizes with the SYNC object (depending on the fieldbus). This SYNC object is to be sent by the higher-level controller in regular intervals. Synchronization occurs as soon as the controller is switched to the *Operational* NMT mode.

### NOTICE



Where possible, it is recommended that a time interval of the *SYNC object* be used.

### 7.6.2 Activation

To activate the mode, the value "7" must be set in object 6060<sub>h</sub> (Modes Of Operation) (see "CiA 402 Power State Machine").

### 7.6.3 Controlword

The following bits in object 6040<sub>h</sub> (controlword) have a special function:

- Bit 4 activates the interpolation when it is set to "1".
- Bit 8 (Halt): If this bit is set to "1", the motor stops. On a transition from "1" to "0", the motor accelerates with the set start ramp to the target speed. On a transition from "0" to "1", the motor brakes and comes to a standstill. The braking deceleration is dependent here on the setting of the "Halt Option Code" in object 605D<sub>h</sub>.

### 7.6.4 Statusword

The following bits in object 6041<sub>h</sub> (statusword) have a special function:

- Bit 10: Target position reached: This bit is set to "1" if the target position was reached (if the halt bit in the controlword is "0") or the axis has speed 0 (if the halt bit in the last control word was "1").
- Bit 12 (IP mode active): This bit is set to "1" if interpolation is active.
- Bit 13 (Following Error): This bit is set in *closed loop* mode if the following error is greater than the set limits (6065<sub>h</sub> (Following Error Window) and 6066<sub>h</sub> (Following Error Time Out)).

### 7.6.5 Use

The controller follows a linearly interpolated path between the current position and the preset target position. The (next) target position must be written in record 60C1<sub>h</sub>:01<sub>h</sub>.



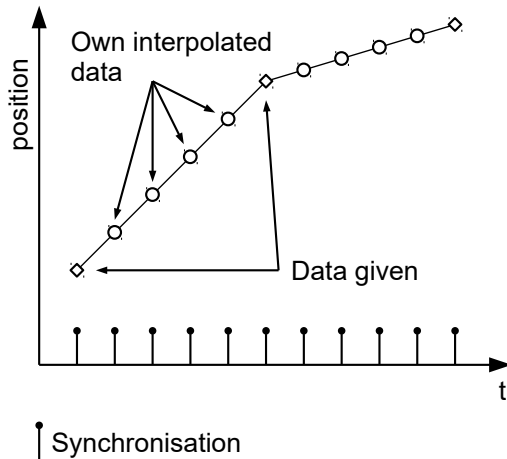

In the current implementation, only

- linear interpolation
- and a target position

are supported.

### 7.6.6 Setup

The following setup is necessary:

- `60C2h:01h`: Time between two passed target positions in ms.
- `60C4h:06h`: This object is to be set to "1" to be able to modify the target position in object `60C1h:01h`.
- `6081h` (Profile Velocity): Maximum speed with which the position is to be approached
- `6084h` (Profile Deceleration): Desired braking deceleration during braking
- `60C6h`: (Max Deceleration): The maximum allowed braking deceleration
- Only if closed loop is activated: The speed is limited by `607Fh` (Max Profile Velocity) and `6080h` (Max Motor Speed); the smaller value is used as the limit.
- To be able to turn the motor, the *power state machine* is to be set to the *Operation enabled* state (see CiA 402 Power State Machine).

### 7.6.7 Operation

After setting up, the task of the higher-level controller is to write the target positions to object `60C1h:01h` in time.

## 7.7 Cyclic Synchronous Position

### 7.7.1 Overview

#### 7.7.1.1 Description

In this mode, the controller receives an absolute position preset via the fieldbus at fixed time intervals (referred to in the following as a *cycle*). The controller then no longer calculates any ramps, but rather only follows the presets.

The target position is transferred cyclically (via *PDO*). Bit 4 in the controlword does not need to be set (unlike the Profile Position mode).



#### NOTICE

The target is absolute and, thus, independent of how often it was sent per *cycle*.

### 7.7.1.2 Synchronization with the SYNC object

To achieve smooth movement, the controller should synchronize with the SYNC object (depending on the field bus). This SYNC object is to be sent by the higher-level controller in regular intervals. Synchronization occurs as soon as the controller is switched to the *Operational* NMT mode.

#### NOTICE



Where possible, it is recommended that a time interval of the *SYNC object* be used for transfer of the target position.

### 7.7.1.3 Activation

To activate the mode, the value "8" must be set in object 6060<sub>h</sub> (Modes Of Operation) (see "CiA 402 Power State Machine").

### 7.7.1.4 Controlword

In this mode, the bits of controlword 6040<sub>h</sub> have no special function.

### 7.7.1.5 Statusword

The following bits in object 6041<sub>h</sub> (statusword) have a special function:

Bit	Value	Description
8	0	The controller is not in sync with the fieldbus
8	1	The controller is in sync with the fieldbus
10	0	Reserved
10	1	Reserved
12	0	Controller does not follow the target; the preset of <u>607A<sub>h</sub></u> (Target Position) is ignored
12	1	Controller follows the target; object <u>607A<sub>h</sub></u> (Target Position) is used as the input for position control.
13	0	No following error
13	1	Following error

Bit 11: Limit exceeded: The demand position is above or below the limit values set in 607D<sub>h</sub>.

## 7.7.2 Object entries

The following objects are necessary for controlling this mode:

- 607A<sub>h</sub> (Target Position): This object must be written cyclically with the position set value.
- 607B<sub>h</sub> (Position Range Limit): This object contains the preset for an overrun or underrun of the position specification.
- 607D<sub>h</sub> (Software Position Limit): This object defines the limitations within which the position specification (607A<sub>h</sub>) must be located.
- 6065<sub>h</sub> (Following Error Window): This object specifies a tolerance corridor in both the positive and negative direction from the set specification. If the actual position is outside of this corridor for longer than the specified time (6066<sub>h</sub>), a following error is reported.
- 6066<sub>h</sub> (Following Error Time Out): This object specifies the time range in milliseconds. If the actual position is outside of the position corridor (6065<sub>h</sub>) for longer than this time range, a following error is triggered.
- 6085<sub>h</sub> (Quick-Stop Deceleration): This object contains the braking deceleration for the case that a quick-stop is triggered.

- **605A<sub>h</sub>** (Quick-Stop Option Code): This object contains the option that is to be executed in the event of a quick-stop.
- Only if **closed loop** is activated: **6080<sub>h</sub>** (Max Motor Speed): Maximum speed
- **60C2<sub>h</sub>:01<sub>h</sub>** (Interpolation Time Period): This object specifies the time of a *cycle*; a new set value must be written in **607A<sub>h</sub>** in these time intervals.  
The following applies here: cycle time = value of **60C2<sub>h</sub>:01<sub>h</sub>** \* 10<sup>value of 60C2:02</sup> seconds.
- **60C2<sub>h</sub>:02<sub>h</sub>** (Interpolation Time Index): This object specifies the time basis of the cycles. Currently, only value **60C2<sub>h</sub>:02<sub>h</sub>=-3** is supported; this yields a time basis of 1 millisecond.
- **60B0<sub>h</sub>** (Position Offset): Offset for the position set value in user-defined units
- **60B1<sub>h</sub>** (Velocity Offset): Offset for the speed set value in user-defined units
- **60B2<sub>h</sub>** (Torque Offset): Offset for the torque set value in tenths of a percent

The following objects can be read in this mode:

- **6064<sub>h</sub>** (Position Actual Value)
- **606C<sub>h</sub>** (Velocity Actual Value)
- **60F4<sub>h</sub>** (Following Error Actual Value)

## 7.8 Cyclic Synchronous Velocity

### 7.8.1 Overview

#### 7.8.1.1 Description

In this mode, the controller passes a speed preset via the fieldbus at fixed time intervals (referred to in the following as a *cycle*). The controller then no longer calculates any ramps, but rather only follows the presets.

#### 7.8.1.2 Activation

To activate the mode, the value "9" must be set in object **6060<sub>h</sub>** (Modes Of Operation) (see "[CiA 402 Power State Machine](#)").

#### 7.8.1.3 Controlword

In this mode, the bits of controlword **6040<sub>h</sub>** have no special function.

#### 7.8.1.4 Statusword

The following bits in object **6041<sub>h</sub>** (statusword) have a special function:

Bit	Value	Description
8	0	The controller is not in sync with the fieldbus
8	1	The controller is in sync with the fieldbus
10	0	Reserved
10	1	Reserved
12	0	Controller does not follow the target; the preset of <b>60FE<sub>h</sub></b> (Target Velocity) is ignored
12	1	Controller follows the target; object <b>60FE<sub>h</sub></b> (Target Velocity) is used as the input for position control.
13	0	Reserved
13	1	Reserved

### 7.8.2 Object entries

The following objects are necessary for controlling this mode:

- **60FE<sub>h</sub>** (Target Velocity): This object must be written cyclically with the speed set value.

- **6085<sub>h</sub>** (Quick-Stop Deceleration): This object contains the braking deceleration for the case that a quick-stop is triggered (see "[CiA 402 Power State Machine](#)").
- **605A<sub>h</sub>** (Quick-Stop Option Code): This object contains the option that is to be executed in the event of a quick-stop (see "[CiA 402 Power State Machine](#)").
- **6080<sub>h</sub>** (Max Motor Speed): Maximum speed
- **60C2<sub>h</sub>:01<sub>h</sub>** (Interpolation Time Period): This object specifies the time of a *cycle*; a new set value must be written in **60FF<sub>h</sub>** in these time intervals.  
The following applies here: cycle time = value of **60C2<sub>h</sub>:01<sub>h</sub>** \* 10<sup>value of **60C2:02**</sup> seconds.
- **60C2<sub>h</sub>:02<sub>h</sub>** (Interpolation Time Index): This object specifies the time basis of the cycles. Currently, only value **60C2<sub>h</sub>:02<sub>h</sub>**=-3 is supported; this yields a time basis of 1 millisecond.
- **60B1<sub>h</sub>** (Velocity Offset): Offset for the speed set value in [user-defined units](#)
- **60B2<sub>h</sub>** (Torque Offset): Offset for the torque set value in tenths of a percent

The following objects can be read in this mode:

- **606C<sub>h</sub>** (Velocity Actual Value)
- **607E<sub>h</sub>** (Polarity)

## 7.9 Cyclic Synchronous Torque

### 7.9.1 Overview

#### 7.9.1.1 Description

In this mode, the controller passes an absolute torque preset via the fieldbus at fixed time intervals (referred to in the following as a *cycle*). The controller then no longer calculates any ramps, but rather only follows the presets.



#### NOTICE

This mode only functions if [closed loop](#) is activated, see also [Commissioning closed loop](#).

#### 7.9.1.2 Activation

To activate the mode, the value "10" must be set in object **6060<sub>h</sub>** (Modes Of Operation) (see "[CiA 402 Power State Machine](#)").

#### 7.9.1.3 Controlword

In this mode, the bits of controlword **6040<sub>h</sub>** have no special function.

#### 7.9.1.4 Statusword

The following bits in object **6041<sub>h</sub>** (statusword) have a special function:

Bit	Value	Description
8	0	The controller is not in sync with the fieldbus
8	1	The controller is in sync with the fieldbus
10	0	Reserved
10	1	Reserved
12	0	Controller does not follow the target; the preset of <b>6071<sub>h</sub></b> (Target Torque) is ignored
12	1	Controller follows the target; object <b>6071<sub>h</sub></b> (Target Torque) is used as the input for position control.
13	0	Reserved
13	1	Reserved

## 7.9.2 Object entries

The following objects are necessary for controlling this mode:

- **6071<sub>h</sub>** (Target Torque): This object must be written cyclically with the torque set value and is to be set relative to **6072<sub>h</sub>**.
- **6072<sub>h</sub>** (Max Torque): Describes the maximum permissible torque.
- **6073<sub>h</sub>** (Max Current):  
Maximum current. The minimum of **6073<sub>h</sub>** and **6072<sub>h</sub>** is used as limit for the torque in **6071<sub>h</sub>**.
- **6080<sub>h</sub>** (Max Motor Speed): Maximum speed
- **60C2<sub>h</sub>:01<sub>h</sub>** (Interpolation Time Period): This object specifies the time of a *cycle*; a new set value must be written in **6071<sub>h</sub>** in these time intervals.  
The following applies here: cycle time = value of **60C2<sub>h</sub>:01<sub>h</sub>** \* 10<sup>value of **60C2:02**</sup> seconds.
- **60C2<sub>h</sub>:02<sub>h</sub>** (Interpolation Time Index): This object specifies the time basis of the cycles. Currently, only value **60C2<sub>h</sub>:02<sub>h</sub>**=-3 is supported; this yields a time basis of 1 millisecond.
- **60B2<sub>h</sub>** (Torque Offset): Offset for the torque set value in tenths of a percent

The following objects can be read in this mode:

- **606C<sub>h</sub>** (Velocity Actual Value)
- **6074<sub>h</sub>** (Torque Demand)

## 7.10 Clock-direction mode

### 7.10.1 Description

In clock-direction mode, the motor is operated via two inputs by a higher-level positioning controller with clock and direction signal. On each clock signal, the motor moves one step in the direction corresponding to the direction signal.

### 7.10.2 Activation

To activate the mode, the value "-1" (or "FFh") must be set in object **6060<sub>h</sub>** (Modes Of Operation) (see "[CiA 402 Power State Machine](#)").

#### NOTICE



To use this mode, you must configure the pins for clock and direction appropriately as described in chapter [Defining input and output assignments](#).

### 7.10.3 General

The following data apply for every subtype of the clock-direction mode:

- The maximum frequency of the input pulse is 1 MHz; the ON pulse should not be less than 200 ns.

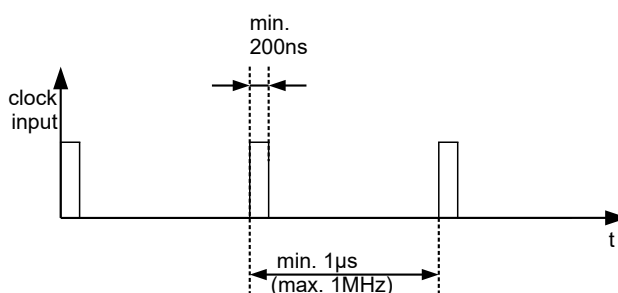

- The demand position resulting from the input pulses is updated cyclically; the cycle time corresponds to the Interpolation Time Period ( $60C2_h$ ). The input pulses that arrive within a cycle are collected and buffered in the controller.
- The steps are scaled using objects  $2057_h$  and  $2058_h$ . The following formula applies here:

$$\text{step width per pulse} = \frac{2057_h}{2058_h}$$

The "step size per pulse" value is set to 128 ( $2057_h=128$  and  $2058_h=1$ ) ex works, which corresponds to a quarter step per pulse. A full step is the value "512", a half step per pulse corresponds to "256", etc.

**NOTICE**



For a stepper motor with 50 pole pairs, 200 full steps correspond to one mechanical revolution of the motor shaft.

In *clock-direction mode*, the BLDC motors are also handled as stepper motors by the controller. This means that for a BLDC motor with, e.g., 3 pole pairs, 12 (=4\*3) full steps correspond to one revolution.

**NOTICE**



If there is a change of direction, a time of at least 35  $\mu\text{s}$  must elapse before the new clock signal is applied.

### 7.10.4 Statusword

The following bits in object  $6041_h$  (statusword) have a special function:

- Bit 13 (Following Error): This bit is set in *closed loop* mode if the following error is greater than the set limits ( $6065_h$  (Following Error Window) and  $6066_h$  (Following Error Time Out)).

### 7.10.5 Subtypes of the clock-direction mode

#### 7.10.5.1 Clock-direction mode (TR mode)

To activate the mode, object  $205B_h$  must be set to the value "0" (factory settings).

In this mode, the pulses must be preset via the clock input; the signal of the direction input specifies the direction of rotation here (see following graphic).

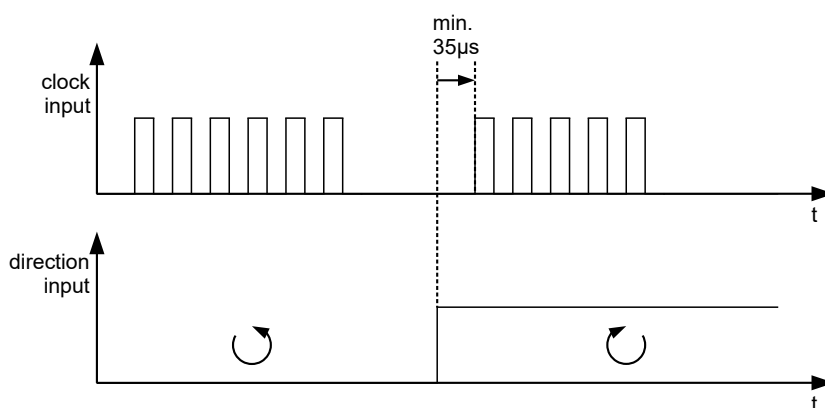

### 7.10.5.2 Right / left rotation mode (CW / CCW mode)

To activate the mode, object `205Bh` must be set to the value "1".

In this mode, the input that is used decides the direction of rotation (see following graphic).

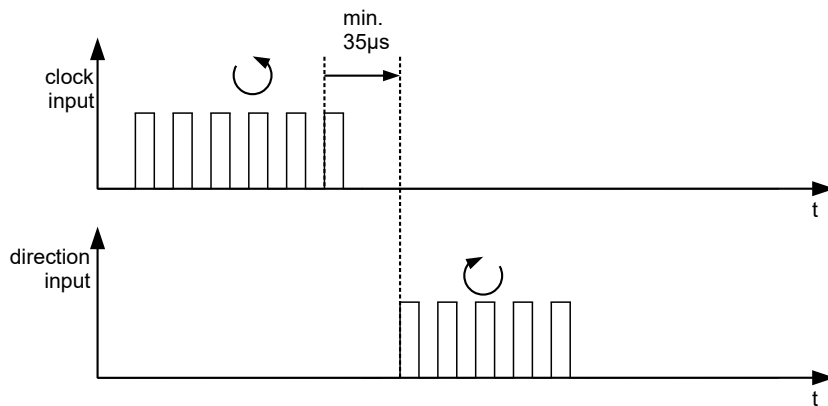

## 7.11 Auto setup

### 7.11.1 Description

To determine a number of parameters related to the motor and the connected sensors (encoders/Hall sensors), an *auto setup* is performed. *Closed-Loop* operation requires a successfully completed *auto setup*. *Auto setup* is only to be performed once during commissioning as long as the motor/sensor connected to the controller is not changed. For details, see [the corresponding section in chapter Commissioning](#).

### 7.11.2 Activation

To activate the mode, the value "-2" ("FE<sub>h</sub>") must be set in object `6060h` (Modes Of Operation) (see [CiA 402 Power State Machine](#)).

### 7.11.3 Controlword

The following bits in object `6040h` (controlword) have a special function:

- Bit 4 starts a travel command. This is carried out on a transition from "0" to "1".

### 7.11.4 Statusword

The following bits in object `6041h` (statusword) have a special function:

- Bit 10: Indexed: indicates whether (= "1") or not (= "0") an encoder index was found.
- Bit 12: Aligned: this bit is set to "1" after *auto setup* has concluded

## 8 Special functions

### 8.1 Digital inputs and outputs

This controller is equipped with 6 digital I/O pins. Of these, 4 can be configured as either input or output. Pins *DIO5\_IO\_MISO* and *DIO6\_IO\_CLK* are preset as inputs.

#### 8.1.1 Defining input and output assignments

Digital inputs/outputs 1...4 can be freely assigned on the PCI connector strip of the device, see also [Pin assignment](#) and [3231h Flex IO Configuration](#).

- Pin 1: *DIO1\_IO\_CS*
- Pin 2: *DIO2\_CD\_CLK*
- Pin 3: *DIO3\_CD\_DIR*
- Pin 4: *DIO4\_IO\_MOSI*

15	14	13	12	11	10	9	8	7	6	5	4	3	2	1	0
													...	Pin 2	Pin 1

- Subindex 03<sub>h</sub> *Alternate Function Mask*: This bit mask defines whether the alternative function of the pin is to be activated.  
To activate an alternative function, set the corresponding bit to "1":

Bit	Pin	Alternative function
1	<i>DIO2_CD_CLK</i>	Clock input in clock-direction mode
2	<i>DIO3_CD_DIR</i>	Direction input in clock-direction mode

#### NOTICE



If you do not activate the alternative function, you can no longer use the corresponding pin as a normal input/output.

If the [Clock-direction mode](#) is activated, the pins for clock and direction are automatically configured accordingly and the settings in 3231<sub>h</sub> are overwritten.

- Subindex 01<sub>h</sub> *Output Mask*: This bit mask defines whether the pin is used as input or output (depending on whether an alternative function was activated for the pin in subindex 03<sub>h</sub>):
  - Bit = "0": Pin is input (default)
  - Bit = "1": Pin is output
- Subindex 02<sub>h</sub> *Pullup Mask*: This bit mask defines whether the pin is a *pullup* or *pulldown*:
  - Bit = "0": Pin is *pulldown* (default)
  - Bit = "1": Pin is *pullup*

Subindex 02<sub>h</sub> is only active for the pin if it is defined as an input.

Example for subindex 01<sub>h</sub>: Pin 2 and pin 3 are to be outputs, value = "6" (=0110<sub>b</sub>)

1. Check which of the pins you would like to assign an alternative function to and set the corresponding bits in 3231<sub>h</sub>:03<sub>h</sub> to "1".
2. Determine which pins you would like to define as input or output.
3. Determine which inputs you would like to define as *pull down* or *pull up*.
4. Set the values in 3231<sub>h</sub>:01<sub>h</sub> and 3321<sub>h</sub>:02<sub>h</sub> accordingly.
5. Store the object by writing the value "65766173<sub>h</sub>" in 1010<sub>h</sub>:03<sub>h</sub> (see chapter [Saving objects](#)) and restart the controller.



## 8.1.2 Bit assignment

The software of the controller assigns each input and output two bits in the respective object (e.g., `60FDh` Digital Inputs or `60FEh` Digital Outputs):

1. The first bit corresponds to the special function of an output or input. These functions are always available on bits 0 to 15 (inclusive) of the respective object. These include the limit switches and the home switch for the digital inputs and the brake control for the outputs.
2. The second bit shows the output/input as a level; these are then available on bits 16 to 31.

### Example

To manipulate the value of output 2, always use bit 17 in `60FEh`.

To activate the "negative limit switch" special function of input 1, set bit 0 in `3240h:01h`; to query the status of the input, read bit 0 in `60FDh`. Bit 16 in `60FDh` also shows the status of input 1 (independent of whether or not the special function of the input was activated).

This assignment is graphically illustrated in the following drawing.

Bits of any object for controlling inputs

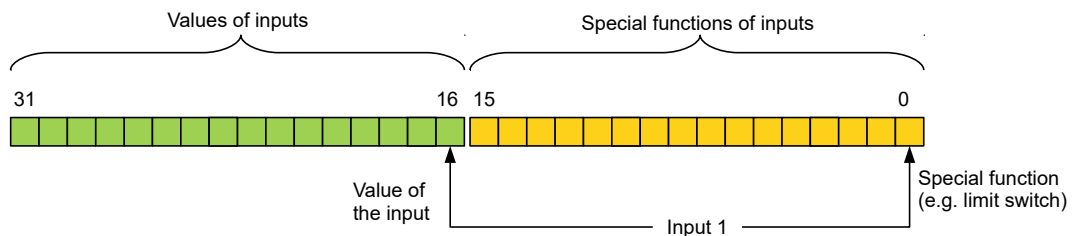

### TIP



The first 4 I/O pins can also be configured as outputs, see [Defining input and output assignments](#). If these are configured as outputs, the current status can still be read back in bits 16 to 19 of object `60FDh`. The assignment of the bits in `60FDh` thereby remains unchanged; bit 20 corresponds to input 5 and bit 21 to input 6.

## 8.1.3 Digital inputs

### 8.1.3.1 Overview

#### NOTICE



For digital inputs with 5 V, the length of the supply lines must not exceed 3 meters.

#### NOTICE



The digital inputs are sampled once per millisecond. Signal changes at the input less than one millisecond in duration are not processed.

The following inputs are available:

PIN/input	Name for Input Routing
B3/DIO1_IO_CS	physical input 1
B4/DIO2_CD_CLK	physical input 2
B5/DIO3_CD_DIR	physical input 3
B6/DIO4_IO_MOSI	physical input 4
B7/DIO5_IO_MISO	physical input 5
B8/DIO6_IO_CLK	physical input 6

### 8.1.3.2 Object entries

The value of an input can be manipulated using the following OD settings, whereby only the corresponding bit acts on the input here.

- **3240<sub>h</sub>:01<sub>h</sub>** (Special Function Enable): This bit allows special functions of an input to be switched off (value "0") or on (value "1"). If input 1 is not used as, e. g., a negative limit switch, the special function must be switched off to prevent an erroneous response to the signal generator. The object has no effect on bits 16 to 31.

The firmware evaluates the following bits:

- Bit 0: Negative limit switch (see [Limitation of the range of motion](#))
- Bit 1: Positive limit switch (see [Limitation of the range of motion](#))
- Bit 2: Home switch (see [Homing](#))
- Bit 3: Interlock (see [interlock function](#))

If, for example, two limit switches and one home switch are used, bits 0–2 in **3240<sub>h</sub>:01<sub>h</sub>** must be set to "1".

- **3240<sub>h</sub>:02<sub>h</sub>** (Function Inverted): This subindex switches from normally open logic (a logical high level at the input yields the value "1" in object **60FD<sub>h</sub>**) to normally closed logic (the logical high level at the input yields the value "0").

This applies for the special functions (except for the clock and direction inputs) and for the normal inputs. If the bit has the value "0", normally open logic applies; for the value "1", normally closed logic applies. Bit 0 changes the logic of input 1, bit 1 changes the logic of input 2, etc.

- **3240<sub>h</sub>:03<sub>h</sub>** (Force Enable): This subindex switches on the software simulation of input values if the corresponding bit is set to "1".  
In this case, the actual values are no longer used in object **3240<sub>h</sub>:04<sub>h</sub>**, but rather the set values for the respective input. Bit 0 corresponds to input 1 here, bit 1 to input 2, etc.
- **3240<sub>h</sub>:04<sub>h</sub>** (Force Value): This bit specifies the value that is to be read as the input value if the same bit was set in object **3240<sub>h</sub>:03<sub>h</sub>**.
- **3240<sub>h</sub>:05<sub>h</sub>** (Raw Value): This object contains the unmodified input value.
- **60FD<sub>h</sub>** (Digital Inputs): This object contains a summary of the inputs and the special functions.

### 8.1.3.3 Computation of the inputs

Computation of the input signal using the example of input 1:

The value at bit 0 of object **60FD<sub>h</sub>** is interpreted by the firmware as negative limit switch; the result of the complete computation is stored in bit 16.

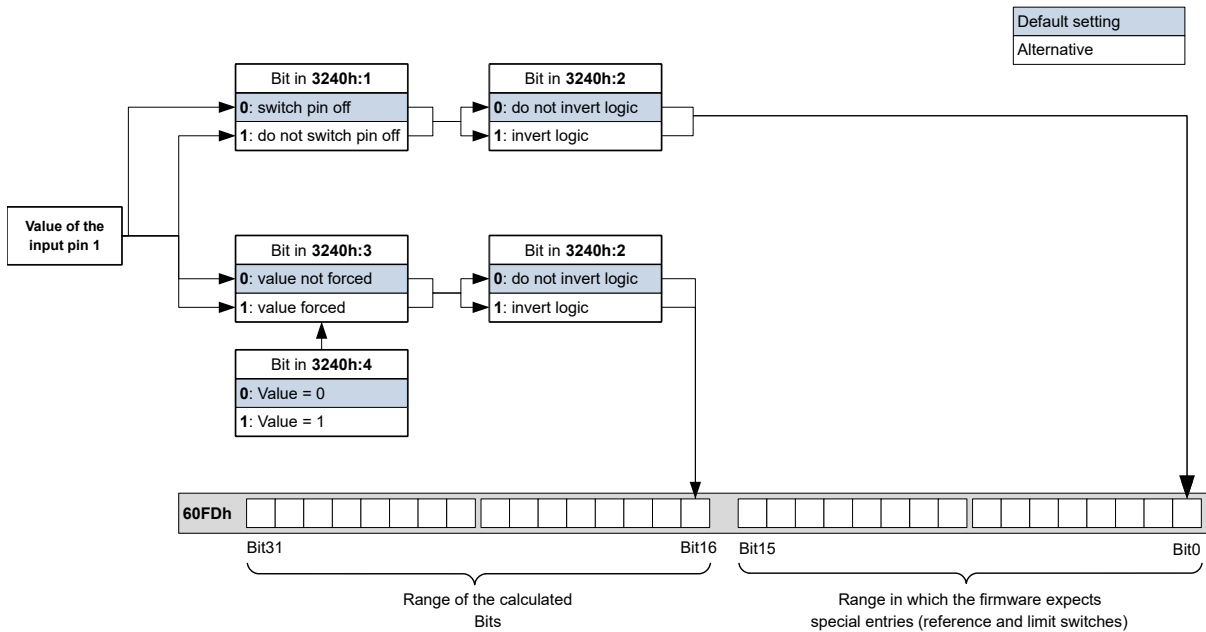

### 8.1.3.4 Input Routing

#### Principle

To perform the assignment of the inputs more flexibly, there is a mode called *Input Routing Mode*. This assigns a signal of a source to a bit in object 60FD<sub>h</sub>.

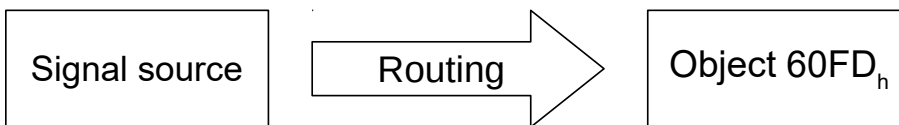

#### Activation

This mode is activated by setting object 3240<sub>h</sub>:08<sub>h</sub> (Routing Enable) to "1" .



#### NOTICE

Entries 3240<sub>h</sub>:01<sub>h</sub> to 3240:04<sub>h</sub> then have **no** function until Input Routing is again switched off.



#### NOTICE

If *Input Routing* is switched on, the initial values of 3242<sub>h</sub> are changed and correspond to the function of the input as it was before activation of *Input Routing*. The inputs of the controller behave the same with activation of *Input Routing*. Therefore, you should not switch back and forth between the normal mode and *Input Routing*.

#### Routing

Object 3242<sub>h</sub> determines which signal source is routed to which bit of 60FD<sub>h</sub>. Subindex 01<sub>h</sub> of 3242<sub>h</sub> determines bit 0, subindex 02<sub>h</sub> determines bit 1, and so forth. The signal sources and their numbers can be found in the following lists.

Number		Signal source
dec	hex	
00	00	Signal is always 0
01	01	physical input 1
02	02	Physical input 2
03	03	Physical input 3
04	04	Physical input 4
05	05	Physical input 5
06	06	Physical input 6
07	07	Physical input 7
08	08	Physical input 8
09	09	Physical input 9
10	0A	physical input 10
11	0B	Physical input 11
12	0C	physical input 12
13	0D	Physical input 13
14	0E	Physical input 14
15	0F	Physical input 15
16	10	Physical input 16
65	41	Hall input "U"
66	42	Hall input "V"
67	43	Hall input "W"
68	44	Encoder input "A"
69	45	Encoder input "B"
70	46	Encoder input "Index"

The following table describes the inverted signals of the previous table.

Number		Signal source
dec	hex	
128	80	Signal is always 1
129	81	Inverted physical input 1
130	82	Inverted physical input 2
131	83	Inverted physical input 3
132	84	Inverted physical input 4
133	85	Inverted physical input 5
134	86	Inverted physical input 6
135	87	Inverted physical input 7
136	88	Inverted physical input 8
137	89	Inverted physical input 9
138	8A	Inverted physical input 10
139	8B	Inverted physical input 11
140	8C	Inverted physical input 12
141	8D	Inverted physical input 13
142	8E	Inverted physical input 14
143	8F	Inverted physical input 15

Number		Signal source
dec	hex	
144	90	Inverted physical input 16
193	C1	Inverted Hall input "U"
194	C2	Inverted Hall input "V"
195	C3	Inverted Hall input "W"
196	C4	Inverted encoder input "A"
197	C5	Inverted encoder input "B"
198	C6	Inverted encoder input "Index"

### Example

Input 1 is to be routed to bit 16 of object  $60FD_h$ :

The number of the signal source for input 1 is "1". The routing for bit 16 is written in  $3242_h:11_h$ .

Hence, object  $3242_h:11_h$  must be set to the value "1".

### 8.1.3.5 Interlock function

The interlock function is a release that you control via bit 3 in  $60FD_h$ . If this bit is set to "1", the motor can move. If the bit is set to "0", the controller switches to the error state and the action stored in  $605E_h$  is executed.

To activate the interlock function, you must switch on the special function by setting bit 3 in  $3240:01_h$  to "1".

Use *Input Routing* to define which signal source is routed to bit 3 of  $60FD_h$  and is to control the interlock function.

### Example

Input 4 is to be routed to bit 3 of object  $60FD_h$  to control the interlock function. A low level is to result in an error state.

1. To activate the *Input Routing*, set  $3240_h:08_h$  to "1".
2. To route input 4 to bit 3, set  $3242_h:04_h$  to "4".

## 8.1.4 Digital outputs

### 8.1.4.1 Outputs

The outputs are controlled via object  $60FE_h$ . Here, output 1 corresponds to bit 16 in object  $60FE_h$ , output 2 corresponds to bit 17, etc., as with the inputs. The first 4 I/O pins can be configured as outputs, see [Defining input and output assignments](#). The outputs with special functions are again entered in the firmware in the lower bits 0 to 15. The only bit assigned at the present time is bit 0, which controls the motor brake.

### 8.1.4.2 Wiring



#### NOTICE

Always observe the maximum capacity of the output (see [Pin assignment](#)).

The digital outputs, with the exception of the brake output, have a digital level of 3.3 V DC. The maximum admissible current is 10 mA.

The brake output is implemented as *open drain*. Hence, an external voltage supply as shown in the following figure is always necessary. See also [Automatic brake control](#).

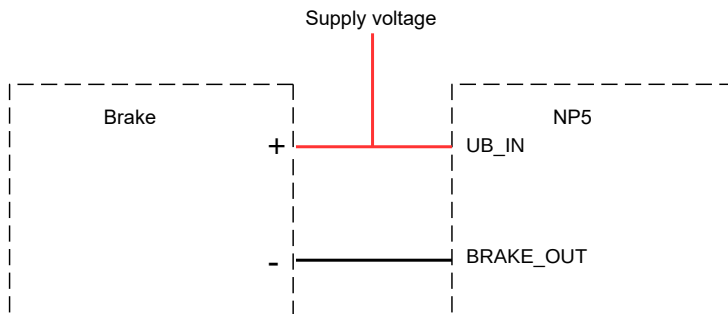

### 8.1.4.3 Object entries

Additional OD entries are available for manipulating the value of the outputs (see the following example for further information). As with the inputs, only the bit at the corresponding location acts on the respective output:

- 3250<sub>h</sub>:01<sub>h</sub>: No function.
- 3250<sub>h</sub>:02<sub>h</sub>: This is used to switch the logic from *normally open* to *normally closed*. Configured as *normally open*, the output outputs a logical high level if the bit is "1". With the *normally closed* configuration, a logical low level is output accordingly for a "1" in object 60FE<sub>h</sub>.
- 3250<sub>h</sub>:03<sub>h</sub>: If a bit is set here, the output is controlled manually. The value for the output is then in object 3250<sub>h</sub>:4<sub>h</sub>; this is also possible for the brake output.
- 3250<sub>h</sub>:04<sub>h</sub>: The bits in this object specify the output value that is to be applied at the output if manual control of the output is activated by means of object 3250<sub>h</sub>:03<sub>h</sub>.
- 3250<sub>h</sub>:05<sub>h</sub>: The bit combination applied to the outputs is stored in this subindex.
- 3250<sub>h</sub>:08<sub>h</sub>: For activating the Output Routing.
- 3250<sub>h</sub>:09<sub>h</sub>: For switching control of the Power LED on/off. If bit 0 is set to "1", the green LED is activated (flashes in normal operation). If bit 1 is set to "1", the red LED is activated (flashes in case of an error). If the bit is set to "0", the respective LED remains off.

### 8.1.4.4 Computation of the outputs

Example for calculating the bits of the outputs:

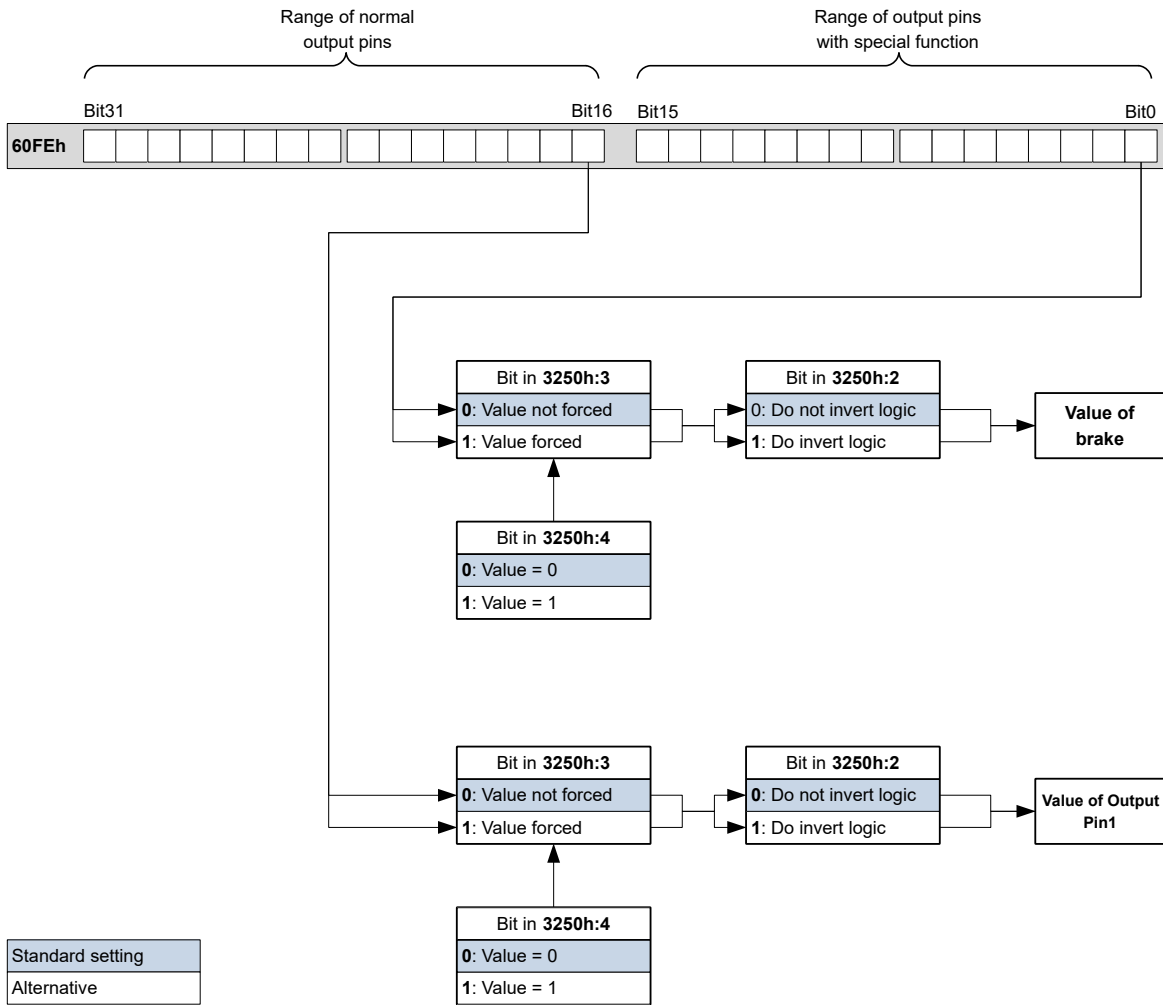

### 8.1.4.5 Output Routing

#### Principle

The "Output Routing Mode" assigns an output a signal source; a control bit in object **60FEh:01h** switches the signal on or off.

The source is selected with **3252h:01** to **n** in the "high byte" (bit 15 to bit 8). The assignment of a control bit from object **60FEh:01h** is performed in the "low byte" (bit 7 to bit 0) of **3252h:01h** to **n** (see following figure).

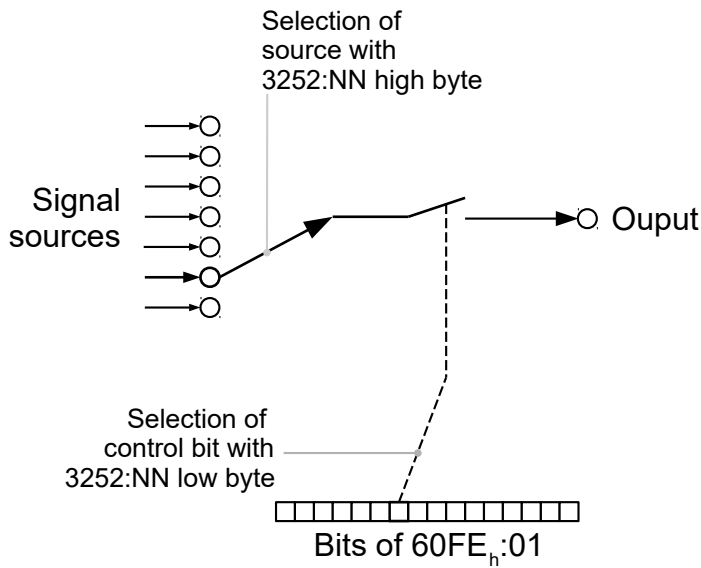

### Activation

This mode is activated by setting object  $3250_h:08_h$  (Routing Enable) to "1" .



**NOTICE**

Entries  $3250_h:01_h$  to  $3250_h:04_h$  then have **no** function until *Output Routing* is again switched off.

### Routing

The subindex of object  $3252_h$  determines which signal source is routed to which output. The output assignments are listed in the following:

Subindex $3252_h$	Output Pin
$01_h$	Configuration of the PWM output (software PWM)
$02_h$	Configuration of output 1
$03_h$	Configuration of output 2 (if available)
...	...
$0n_h$	Configuration of output n (if available)



**NOTICE**

The maximum output frequency of the PWM output (software PWM) is 2 kHz. All other outputs can only produce signals up to 500 Hz.

Subindices  $3252_h:01_h$  to  $0n_h$  are 16 bits wide, whereby the high byte selects the signal source (e. g., the PWM generator) and the low byte determines the control bit in object  $60FE_h:01$ .

Bit 7 of  $3252_h:01_h$  to  $0n_h$  inverts the controller from object  $60FE_h:01$ . Normally, value "1" in object  $60FE_h:01_h$  switches on the signal; if bit 7 is set, the value "0" switches on the signal.



**TIP**

To deactivate routing, enter the value FFFF<sub>h</sub>.

**Number in 3252:01 to 0n**

00XX <sub>h</sub>	Output is always "1"
01XX <sub>h</sub>	Output is always "0"
02XX <sub>h</sub>	Encoder signal (6063 <sub>h</sub> ) with frequency divider 1
03XX <sub>h</sub>	Encoder signal (6063 <sub>h</sub> ) with frequency divider 2
04XX <sub>h</sub>	Encoder signal (6063 <sub>h</sub> ) with frequency divider 4
05XX <sub>h</sub>	Encoder signal (6063 <sub>h</sub> ) with frequency divider 8
06XX <sub>h</sub>	Encoder signal (6063 <sub>h</sub> ) with frequency divider 16
07XX <sub>h</sub>	Encoder signal (6063 <sub>h</sub> ) with frequency divider 32
08XX <sub>h</sub>	Encoder signal (6063 <sub>h</sub> ) with frequency divider 64
09XX <sub>h</sub>	Position Actual Value (6064 <sub>h</sub> ) with frequency divider 1
0AXX <sub>h</sub>	Position Actual Value (6064 <sub>h</sub> ) with frequency divider 2
0BXX <sub>h</sub>	Position Actual Value (6064 <sub>h</sub> ) with frequency divider 4
0CXX <sub>h</sub>	Position Actual Value (6064 <sub>h</sub> ) with frequency divider 8
0DXX <sub>h</sub>	Position Actual Value (6064 <sub>h</sub> ) with frequency divider 16
0EXX <sub>h</sub>	Position Actual Value (6064 <sub>h</sub> ) with frequency divider 32
0FXX <sub>h</sub>	Position Actual Value (6064 <sub>h</sub> ) with frequency divider 64
10XX <sub>h</sub>	PWM signal that is configured with object 2038 <sub>h</sub> :05 <sub>h</sub> and 06 <sub>h</sub>
11XX <sub>h</sub>	Inverted PWM signal that is configured with object 2038 <sub>h</sub> :05 <sub>h</sub> and 06 <sub>h</sub>

**NOTICE**

On any change of the "encoder signal" (6063<sub>h</sub>) or the current position (6064<sub>h</sub> in user-defined units) by an increment, a pulse is output at the digital input (for frequency divider 1). Take this into account when selecting the frequency divider and the unit, especially when using sensors with low resolution (such as Hall sensors).

**Example**

The encoder signal (6063<sub>h</sub>) is to be applied to output 1 with a frequency divider 4. The output is to be controlled with bit 5 of object 60FE:01.

- 3250<sub>h</sub>:08<sub>h</sub> = 1 (activate routing)
- 3252<sub>h</sub>:02<sub>h</sub> = 0405<sub>h</sub> (04XX<sub>h</sub> + 0005<sub>h</sub>)
- 04XX<sub>h</sub>: Encoder signal with frequency divider 4
- 0005<sub>h</sub>: Selection of bit 5 of 60FE:01

The output is switched on by setting bit 5 in object 60FE:01.

**Example**

The brake PWM signal is to be applied to output 2. Because the automatic brake control uses bit 0 of 60FE:01<sub>h</sub>, this should be used as control bit.

- $3250_{\text{h}}:08_{\text{h}} = 1$  (activate routing)
- $3252_{\text{h}}:03_{\text{h}} = 1080_{\text{h}} (=10\text{XX}_{\text{h}} + 0080_{\text{h}})$ . Where:
  - $10\text{XX}_{\text{h}}$ : Brake PWM signal
  - $0080_{\text{h}}$ : Selection of the inverted bit 0 of object  $60\text{FE}:01$

## 8.2 Automatic brake control

### 8.2.1 Description

Automatic brake control is activated if the controller is switched to the *Operation enabled* state of the CiA 402 Power State Machine; the brake otherwise always remains closed.

The brake output of the controller results in a PWM signal that can be adjusted with respect to frequency and duty cycle.

For information on the interaction of the brake with the motor stopping behavior, see also chapter Power State machine – halt motion reactions.

### 8.2.2 Activation and connection

The brake can be controlled either automatically or manually:

- Automatic: Setting bit 2 of object  $3202_{\text{h}}$  to "1" activates the brake control.
- Manual: Setting bit 2 of object  $3202_{\text{h}}$  to "0" deactivates the brake control; the brake can now be controlled with bit 0 in object  $60\text{FE}_{\text{h}}:01_{\text{h}}$ .

#### 8.2.2.1 Connection

The brake output is located:

- On pin A48 of the PCI connector strip; see Pin assignment and Wiring of the outputs
- On connector X2 of the Discovery Board, if this is used; see Connector X2 – brake

### 8.2.3 Brake control

The following graphic shows the states of the CiA 402 Power State Machine together with the states of the brake for the automatic mode.

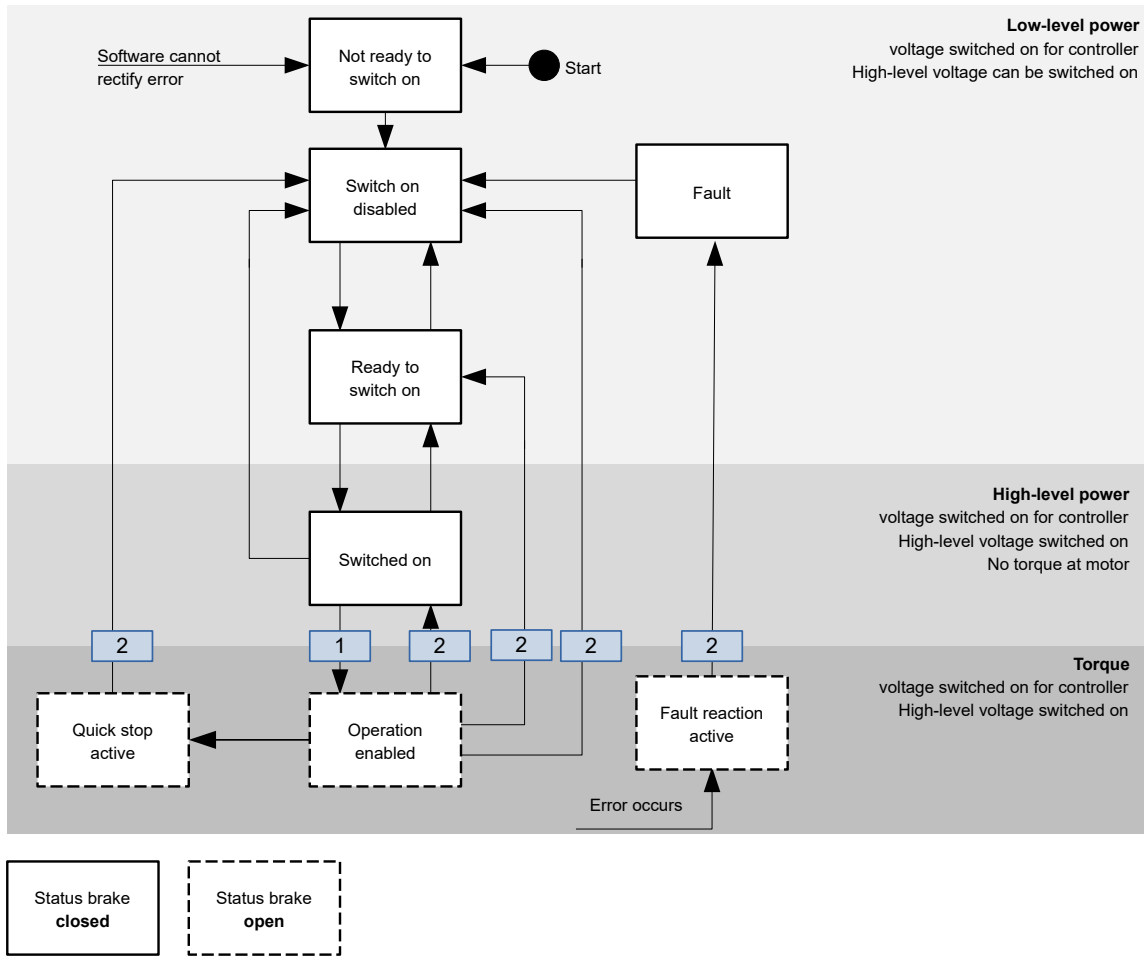

The following steps are performed on the transition, which is marked with 1:

1. The motor current is switched on.
2. The time stored in  $2038_h:3_h$  is allowed to elapse.
3. The brake releases.
4. The time stored in  $2038_h:4_h$  is allowed to elapse.
5. The *Operation enabled* state is reached, the motor controller can perform travel commands.

The following steps are performed on all transitions that are marked with 2:

1. The motor is brought to a standstill.
2. The time stored in  $2038_h:1_h$  is allowed to elapse.
3. The brake is activated.
4. The time stored in  $2038_h:2_h$  is allowed to elapse.
5. The motor current is switched off.

### 8.2.4 Brake PWM

The switched-on brake generates a PWM signal at the output of the controller that can be adjusted with respect to duty cycle and frequency. If an output pin without PWM is needed, a duty cycle of 100 percent can be set.

### NOTICE

The *Brake +* pin of the brake output is connected to the voltage supply of the controller via the *Discovery Board*.



If the operating voltage of the brake is greater than the supply voltage of the controller, you cannot use the brake output of the controller; you must supply the brake externally.

If the supply voltage of the controller is greater than the operating voltage of the brake (and up to 48 V DC), it is recommended that the PWM controller from Nanotec with order designation *EB-BRAKE-48V* be used and the duty cycle of the controller brake output be set to "100".

#### 8.2.4.1 Frequency

The frequency of the brake PWM can be set in object `2038h:5h`. The unit is Hertz; a value less than 50 or greater than 2000 is not possible.

#### 8.2.4.2 Duty cycle

The duty cycle – the ratio of pulse to period duration – is set in `2038h:6h`. The value is a percentage and can be selected between 2 and 100. With a value of 100, the output pin is permanently switched on.

In the following figure, example duty cycles of 25 and 50 percent are shown, whereby the frequency is held constant.

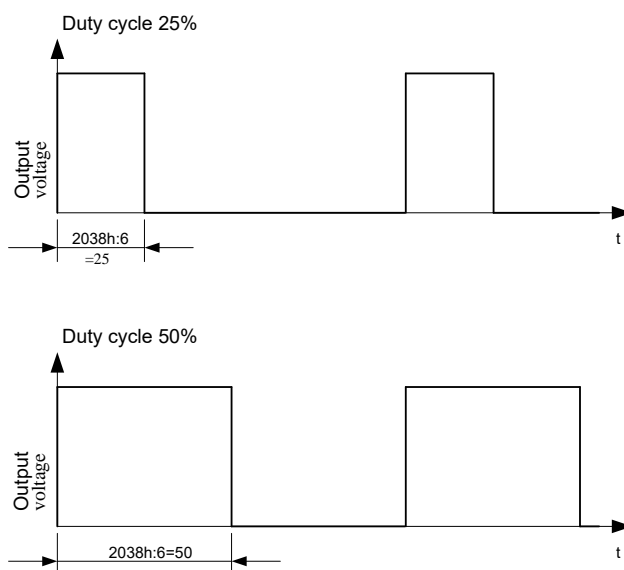

### 8.3 External ballast circuit

During braking, electrical energy is fed back into the DC-link through self-induction of the motor. If not using a power supply with regenerative-feedback capability, the brake power can cause the DC-link voltage to increase which, if no additional measures are taken, is limited only by the internal consumption and capacitances in the DC-link.

To prevent damage to the controller through overvoltage, it may – depending on the level of the braking power – be necessary to dissipate excess energy in the form of heat. For this purpose, the controller provides an output at pin (pin B27) for controlling an external ballast circuit that consists of a driver, a MOSFET as switch, and a sufficiently dimensioned ballast resistor (see [Example of a ballast circuit](#)).

#### 8.3.1 Control of the ballast resistor

A ballast controller and monitor that has two functions is implemented in the firmware of the controller:

- Limitation of the DC-link voltage through activation of the ballast resistor or shutdown of the output stage

- Protection of the ballast resistor against thermal overload

The parameters to be configured are described in the following chapters.

### 8.3.2 Activating the ballast

To activate the ballast, set bit 0 in  $4021_h:01_h$  to "1". If you would like to invert the polarity of the pin for controlling the external ballast circuit (B27, on delivery: *active high*), set bit 1 in  $4021_h:01_h$  to "1".

Enter the response threshold in millivolts as well as the hysteresis when switching on/off in  $4021_h:02_h$  and  $4021_h:03_h$ , respectively.

If, in spite of the activation, the ballast is not able to limit the increase in the DC-link voltage, an error is generated and the driver output stage switched off when the overvoltage threshold ( $2034_h$ ) is exceeded.

### 8.3.3 Ballast monitoring

The firmware constantly monitors the ballast resistor by adding up the energy it converts – taking into account the thermal energy that the resistor discharges to its surroundings through convection.

If the energy exceeds the permissible limit value, the ballast resistor is blocked from switching on and a warning generated with error code  $7113_h$  (see  $1003_h$ ). After the resistor has cooled sufficiently, the block is automatically canceled.

To configure the monitoring, you must ascertain or determine the following resistor parameters from the data sheet of the ballast resistor and enter them in the corresponding subindex of  $4021_h$ :

#### Nominal Resistance $R_{Ballast}$ [mOhm]

Rated value of the ballast resistor

#### Cooling Power $P_{Stat\_TA\_Max}$ [mW]

The amount of heat that the resistor can/may constantly discharge to its surroundings. You can calculate these as follows:

$$P_{Stat\_TA\_Max} = (T_{Ballast\_Max} - T_{A\_Max}) / R_{th,A}$$

- $T_{Ballast\_Max}$ : Maximum permissible surface temperature of the resistor. Limited by the data of the resistor (data sheet value) or by the installation position (temperature stability of adjacent components).
- $T_{A\_Max}$ : Maximum temperature in the surroundings of the ballast
- $R_{th,A}$ : Thermal resistance of the ballast resistor to the surroundings (data sheet value)

#### Short Term Energy Limit $E_{ST\_25^\circ C}$ [mWs]

Amount of energy that can be supplied to the resistor within a short load surge (<1 second) without overloading it.

The material of the resistor element (wire, thick film) is the limiting factor here as, in the case of short pulses, practically only it can absorb energy and heats up.

For load resistors, the value is typically specified in the data sheet.

#### Long Term Energy Limit $E_{LT\_TA\_Max}$ [mWs]

Amount of energy that can be supplied to the resistor within the *Long Term Reference Time* (see below, typically between 1 and 5 seconds) without overloading it.

In the case of long pulses, the carrier material (cement or ceramic body) also absorbs energy and thereby slows the temperature rise.

The long-term overload capacity of a load resistor is typically specified in its data sheet in the form of an overload factor for a certain length of time (e.g. 5x rated power for 5 seconds).

**Long Term Reference Time  $t_{LT\_Ref}$  [ms]**

The reference time for the Long Term Energy Limit (typically between 1 and 5 seconds)

If the parameters are not valid or realistic, an error is generated with error code 7110<sub>h</sub> (see 1003<sub>h</sub>).

**8.3.4 Example of a ballast circuit**

The following section from the circuit diagram of the *NP5 Discovery Board* (see [Hardware installation](#)), can serve as a reference for the development of your own ballast circuit.

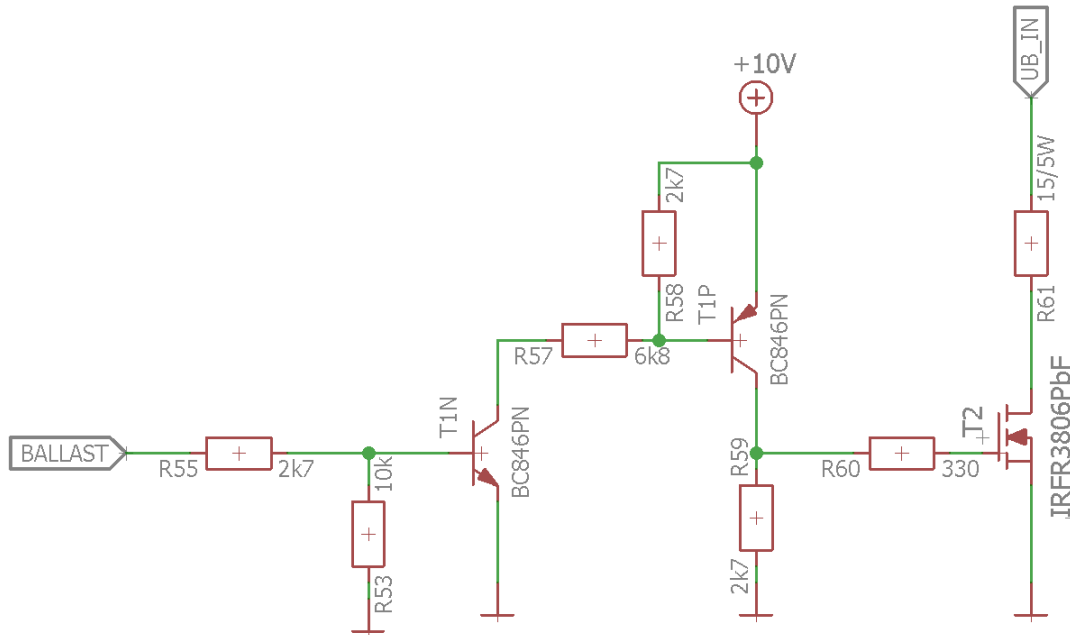

The used ballast resistor is a CR257-05T15R from VITROHM. The circuit is controlled via pin *BALLAST* (B27).



**TIP**

Nanotec recommends using a wirewound resistor due to its pulse strength.

The following parameters, which you enter in the corresponding subindex of 4021<sub>h</sub>, are based on the data sheet values and the installation position on the *Discovery Board*:

Subindex	Parameter	Value
04 <sub>h</sub>	Nominal Resistance	15000
05 <sub>h</sub>	Long Term Energy Limit	162714
06 <sub>h</sub>	Long Term Reference Time	1000
07 <sub>h</sub>	Short Term Energy Limit	29200
08 <sub>h</sub>	Cooling Power	2258

## 8.4 I<sup>2</sup>t Motor overload protection

### 8.4.1 Description

#### NOTICE



For stepper motors, only the rated current is specified, not a maximum current. No liability is therefore assumed when using I<sup>2</sup>t with stepper motors.

The goal of I<sup>2</sup>t motor overload protection is to protect the motor from damage and, at the same time, operate it normally up to its thermal limit.

This function is only available if the controller is in the closed loop mode (bit 0 of object 3202<sub>h</sub> must be set to "1").

### 8.4.2 Object entries

The following objects affect I<sup>2</sup>t motor overload protection:

- 2031<sub>h</sub>: Max Motor Current – specifies the maximum permissible motor current in mA.
- 203B<sub>h</sub>:1<sub>h</sub> Motor Rated Current – specifies the rated current in mA.
- 6073<sub>h</sub> Max Current – specifies the maximum current in tenths of a percent of the set rated current.
- 203B<sub>h</sub>:2<sub>h</sub> Maximum Duration Of Peak Current – specifies the maximum duration of the maximum current in ms.

The following objects indicate the current state of I<sup>2</sup>t:

- 203B<sub>h</sub>:3<sub>h</sub> Threshold – specifies the limit in A<sup>2</sup>ms that determines whether the maximum current or rated current is switched to.
- 203B<sub>h</sub>:4<sub>h</sub> CalcValue – specifies the calculated value in A<sup>2</sup>ms that is compared with the threshold for setting the current.
- 203B<sub>h</sub>:5<sub>h</sub> LimitedCurrent – shows the momentary current value in mA that was set by I<sup>2</sup>t.
- 203B<sub>h</sub>:6<sub>h</sub> Status:
  - Value = "0": I<sup>2</sup>t deactivated
  - Value = "1": I<sup>2</sup>t activated

### 8.4.3 Activation

*Closed loop* must be activated, (bit 0 of object 3202<sub>h</sub> set to "1", see also chapter Closed-Loop).

To activate the mode, you must appropriately specify the four object entries mentioned above (2031<sub>h</sub>, 6073<sub>h</sub>, 203B<sub>h</sub>:1<sub>h</sub>, 203B<sub>h</sub>:2<sub>h</sub>). This means that the maximum current must be greater than the rated current and a time value for the maximum duration of the maximum current must be entered. If these conditions are not met, the I<sup>2</sup>t functionality remains deactivated.

### 8.4.4 Function of I<sup>2</sup>t

From the specification of rated current, maximum current and maximum duration of the maximum current, an I<sup>2</sup>t<sub>Lim</sub> is calculated.

The motor can run with maximum current until the calculated I<sup>2</sup>t<sub>Lim</sub> is reached. The current is then immediately reduced to the rated current. The maximum current is limited by the maximum motor current (2031<sub>h</sub>).

The relationships are illustrated again in the following diagrams.

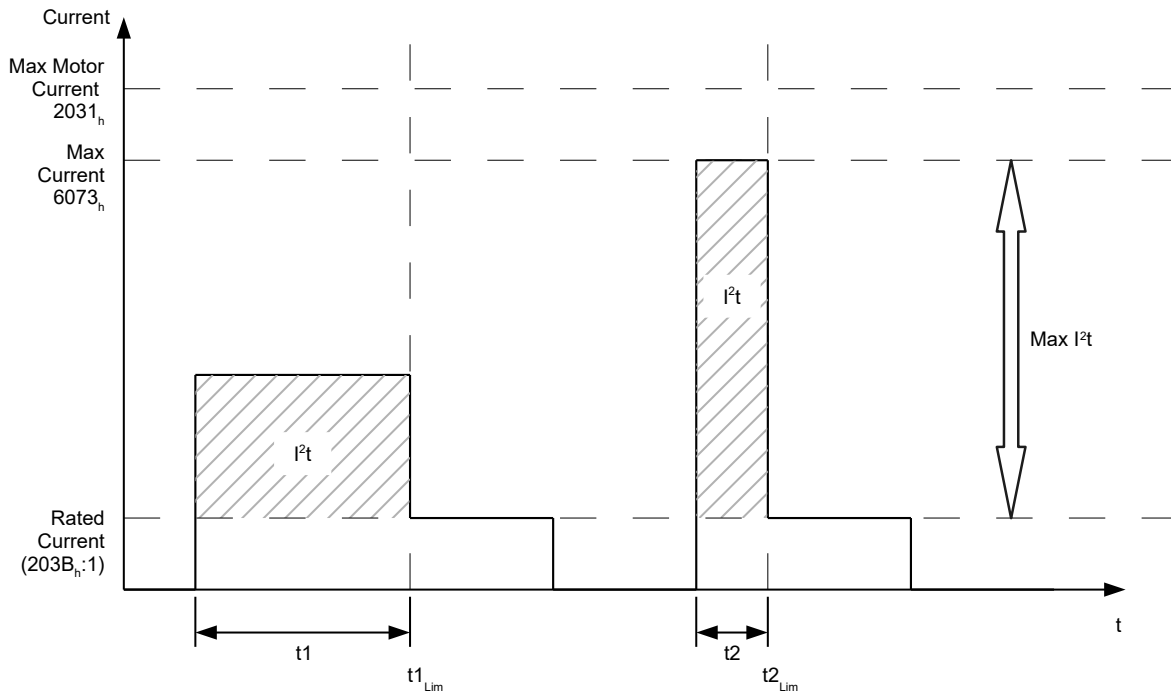

In the first section,  $t_1$ , the current value is higher than the rated current. At time  $t_{1\_Lim}$ ,  $I^2_{t\_Lim}$  is reached and the current is limited to the rated current. A current that corresponds to the maximum current then occurs for a period of time  $t_2$ . Hence, the value for  $I^2_{t\_Lim}$  is reached more quickly than in time  $t_1$ .

## 8.5 Saving objects

### NOTICE



Improper use of the function can result in it no longer being possible to start the controller. Therefore, carefully read the entire chapter before using the function.

### 8.5.1 General

Many objects in the object dictionary can be saved and then automatically reloaded the next time the controller is switched on or reset. Furthermore, the saved values are also retained following a firmware update.

Only entire collections of objects (referred to in the following as *categories*) can be saved together; individual objects cannot be saved.

An object can be assigned one of the following *categories*:

- Communication: Parameters related to external interfaces, such as PDO configuration etc.
- Application: Parameters related to operating modes.
- Customer: Parameters that are written and read by the customer/user only and are ignored by the controller firmware.
- Drive: Parameters related to the motor and the sensors (BLDC/Stepper, *closed/open-loop*...). Some are set and saved by auto setup.
- Tuning: Parameters related to motor and encoder that are set either by auto setup or that can be found in the data sheets, e.g., pole pairs and maximum current.
- CANopen: Parameters related to CANopen communication

If an object is not assigned one of these *categories*, it cannot be saved, e.g., statusword and all objects whose value is dependent on the current state of the controller.



The objects in each *category* are listed below. In chapter [Description of the object dictionary](#), the corresponding *category* for each object is also specified.

### 8.5.2 Category: communication

- 1005<sub>h</sub>: COB-ID Sync
- 1006<sub>h</sub>: Communication Cycle Period
- 1007<sub>h</sub>: Synchronous Window Length
- 100C<sub>h</sub>: Guard Time
- 100D<sub>h</sub>: Live Time Factor
- 1014<sub>h</sub>: COB-ID EMCY
- 1016<sub>h</sub>: Consumer Heartbeat Time
- 1017<sub>h</sub>: Producer Heartbeat Time
- 1019<sub>h</sub>: Synchronous Counter Overflow Value
- 1029<sub>h</sub>: Error Behavior
- 1400<sub>h</sub>: Receive PDO 1 Communication Parameter
- 1401<sub>h</sub>: Receive PDO 2 Communication Parameter
- 1402<sub>h</sub>: Receive PDO 3 Communication Parameter
- 1403<sub>h</sub>: Receive PDO 4 Communication Parameter
- 1404<sub>h</sub>: Receive PDO 5 Communication Parameter
- 1405<sub>h</sub>: Receive PDO 6 Communication Parameter
- 1406<sub>h</sub>: Receive PDO 7 Communication Parameter
- 1407<sub>h</sub>: Receive PDO 8 Communication Parameter
- 1600<sub>h</sub>: Receive PDO 1 Mapping Parameter
- 1601<sub>h</sub>: Receive PDO 2 Mapping Parameter
- 1602<sub>h</sub>: Receive PDO 3 Mapping Parameter
- 1603<sub>h</sub>: Receive PDO 4 Mapping Parameter
- 1604<sub>h</sub>: Receive PDO 5 Mapping Parameter
- 1605<sub>h</sub>: Receive PDO 6 Mapping Parameter
- 1606<sub>h</sub>: Receive PDO 7 Mapping Parameter
- 1607<sub>h</sub>: Receive PDO 8 Mapping Parameter
- 1800<sub>h</sub>: Transmit PDO 1 Communication Parameter
- 1801<sub>h</sub>: Transmit PDO 2 Communication Parameter
- 1802<sub>h</sub>: Transmit PDO 3 Communication Parameter
- 1803<sub>h</sub>: Transmit PDO 4 Communication Parameter
- 1804<sub>h</sub>: Transmit PDO 5 Communication Parameter
- 1805<sub>h</sub>: Transmit PDO 6 Communication Parameter
- 1806<sub>h</sub>: Transmit PDO 7 Communication Parameter
- 1807<sub>h</sub>: Transmit PDO 8 Communication Parameter
- 1A00<sub>h</sub>: Transmit PDO 1 Mapping Parameter
- 1A01<sub>h</sub>: Transmit PDO 2 Mapping Parameter
- 1A02<sub>h</sub>: Transmit PDO 3 Mapping Parameter
- 1A03<sub>h</sub>: Transmit PDO 4 Mapping Parameter
- 1A04<sub>h</sub>: Transmit PDO 5 Mapping Parameter
- 1A05<sub>h</sub>: Transmit PDO 6 Mapping Parameter
- 1A06<sub>h</sub>: Transmit PDO 7 Mapping Parameter
- 1A07<sub>h</sub>: Transmit PDO 8 Mapping Parameter
- 1F80<sub>h</sub>: NMT Startup
- 2102<sub>h</sub>: Fieldbus Module Control

### 8.5.3 Category: application

- 2034<sub>h</sub>: Upper Voltage Warning Level
- 2035<sub>h</sub>: Lower Voltage Warning Level

- 2036<sub>h</sub>: Open Loop Current Reduction Idle Time
- 2037<sub>h</sub>: Open Loop Current Reduction Value/factor
- 2038<sub>h</sub>: Brake Controller Timing
- 203A<sub>h</sub>: Homing On Block Configuration
- 203D<sub>h</sub>: Torque Window
- 203E<sub>h</sub>: Torque Window Time Out
- 203F<sub>h</sub>: Max Slippage Time Out
- 2057<sub>h</sub>: Clock Direction Multiplier
- 2058<sub>h</sub>: Clock Direction Divider
- 205B<sub>h</sub>: Clock Direction Or Clockwise/Counter Clockwise Mode
- 2084<sub>h</sub>: Bootup Delay
- 2290<sub>h</sub>: PDI Control
- 2300<sub>h</sub>: NanoJ Control
- 2410<sub>h</sub>: NanoJ Init Parameters
- 2800<sub>h</sub>: Bootloader And Reboot Settings
- 3210<sub>h</sub>: Motor Drive Parameter Set
- 3212<sub>h</sub>: Motor Drive Flags
- 321A<sub>h</sub>: Current Controller Parameters
- 321B<sub>h</sub>: Velocity Controller Parameters
- 321C<sub>h</sub>: Position Controller Parameters
- 321D<sub>h</sub>: Pre-control
- 321E<sub>h</sub>: Voltage Limit
- 3231<sub>h</sub>: Flex IO Configuration
- 3240<sub>h</sub>: Digital Inputs Control
- 3242<sub>h</sub>: Digital Input Routing
- 3243<sub>h</sub>: Digital Input Homing Capture
- 3250<sub>h</sub>: Digital Outputs Control
- 3252<sub>h</sub>: Digital Output Routing
- 3321<sub>h</sub>: Analog Input Offsets
- 3322<sub>h</sub>: Analog Input Numerators
- 3323<sub>h</sub>: Analog Input Denominators
- 3700<sub>h</sub>: Deviation Error Option Code
- 3701<sub>h</sub>: Limit Switch Error Option Code
- 4013<sub>h</sub>: HW Configuration
- 6007<sub>h</sub>: Abort Connection Option Code
- 6040<sub>h</sub>: Controlword
- 6042<sub>h</sub>: VI Target Velocity
- 6046<sub>h</sub>: VI Velocity Min Max Amount
- 6048<sub>h</sub>: VI Velocity Acceleration
- 6049<sub>h</sub>: VI Velocity Deceleration
- 604A<sub>h</sub>: VI Velocity Quick Stop
- 604C<sub>h</sub>: VI Dimension Factor
- 605A<sub>h</sub>: Quick Stop Option Code
- 605B<sub>h</sub>: Shutdown Option Code
- 605C<sub>h</sub>: Disable Option Code
- 605D<sub>h</sub>: Halt Option Code
- 605E<sub>h</sub>: Fault Option Code
- 6060<sub>h</sub>: Modes Of Operation
- 6065<sub>h</sub>: Following Error Window
- 6066<sub>h</sub>: Following Error Time Out
- 6067<sub>h</sub>: Position Window
- 6068<sub>h</sub>: Position Window Time
- 606D<sub>h</sub>: Velocity Window

- 606E<sub>h</sub>: Velocity Window Time
- 606F<sub>h</sub>: Velocity Threshold
- 6070<sub>h</sub>: Velocity Threshold Time
- 6071<sub>h</sub>: Target Torque
- 6072<sub>h</sub>: Max Torque
- 607A<sub>h</sub>: Target Position
- 607B<sub>h</sub>: Position Range Limit
- 607C<sub>h</sub>: Home Offset
- 607D<sub>h</sub>: Software Position Limit
- 607E<sub>h</sub>: Polarity
- 607F<sub>h</sub>: Max Profile Velocity
- 6081<sub>h</sub>: Profile Velocity
- 6082<sub>h</sub>: End Velocity
- 6083<sub>h</sub>: Profile Acceleration
- 6084<sub>h</sub>: Profile Deceleration
- 6085<sub>h</sub>: Quick Stop Deceleration
- 6086<sub>h</sub>: Motion Profile Type
- 6087<sub>h</sub>: Torque Slope
- 6091<sub>h</sub>: Gear Ratio
- 6092<sub>h</sub>: Feed Constant
- 6096<sub>h</sub>: Velocity Factor
- 6097<sub>h</sub>: Acceleration Factor
- 6098<sub>h</sub>: Homing Method
- 6099<sub>h</sub>: Homing Speed
- 609A<sub>h</sub>: Homing Acceleration
- 60A2<sub>h</sub>: Jerk Factor
- 60A4<sub>h</sub>: Profile Jerk
- 60A8<sub>h</sub>: SI Unit Position
- 60A9<sub>h</sub>: SI Unit Velocity
- 60B0<sub>h</sub>: Position Offset
- 60B1<sub>h</sub>: Velocity Offset
- 60B2<sub>h</sub>: Torque Offset
- 60C1<sub>h</sub>: Interpolation Data Record
- 60C2<sub>h</sub>: Interpolation Time Period
- 60C4<sub>h</sub>: Interpolation Data Configuration
- 60C5<sub>h</sub>: Max Acceleration
- 60C6<sub>h</sub>: Max Deceleration
- 60E8<sub>h</sub>: Additional Gear Ratio - Motor Shaft Revolutions
- 60E9<sub>h</sub>: Additional Feed Constant - Feed
- 60ED<sub>h</sub>: Additional Gear Ratio - Driving Shaft Revolutions
- 60EE<sub>h</sub>: Additional Feed Constant - Driving Shaft Revolutions
- 60F2<sub>h</sub>: Positioning Option Code
- 60F8<sub>h</sub>: Max Slippage
- 60FE<sub>h</sub>: Digital Outputs
- 60FF<sub>h</sub>: Target Velocity

### 8.5.4 Category: customer

- 2701<sub>h</sub>: Customer Storage Area

### 8.5.5 Category: drive

- 3202<sub>h</sub>: Motor Drive Submode Select
- 320D<sub>h</sub>: Torque Of Inertia Factor

- 6073<sub>h</sub>: Max Current
- 6080<sub>h</sub>: Max Motor Speed

### 8.5.6 Category: tuning

- 2030<sub>h</sub>: Pole Pair Count
- 2031<sub>h</sub>: Max Motor Current
- 203B<sub>h</sub>: I2t Parameters
- 3203<sub>h</sub>: Feedback Selection
- 3380<sub>h</sub>: Feedback Sensorless
- 3390<sub>h</sub>: Feedback Hall
- 33A0<sub>h</sub>: Feedback Incremental A/B/I 1
- 33A1<sub>h</sub>: Feedback Incremental A/B/I 2
- 4021<sub>h</sub>: Ballast Configuration
- 6075<sub>h</sub>: Motor Rated Current
- 608F<sub>h</sub>: Position Encoder Resolution
- 6090<sub>h</sub>: Velocity Encoder Resolution
- 60E6<sub>h</sub>: Additional Position Encoder Resolution - Encoder Increments
- 60EB<sub>h</sub>: Additional Position Encoder Resolution - Motor Revolutions

### 8.5.7 Category: CANopen

- 2005<sub>h</sub>: CANopen Baudrate
- 2006<sub>h</sub>: CANopen WheelConfig
- 2007<sub>h</sub>: CANopen Config
- 2009<sub>h</sub>: CANopen NodeID

### 8.5.8 Starting the save process

#### CAUTION



#### Uncontrolled motor movements!

Control may be affected while saving. Unforeseen reactions can result.

- ▶ The motor must be at a standstill before starting the saving process. The motor must not be started while saving.

#### NOTICE



- Saving may take a few seconds. Never interrupt the power supply while saving. The state of the saved objects is otherwise undefined.
- Always wait until the controller has signaled that the save process has been successfully completed with the value "1" in the corresponding subindex in object 1010<sub>h</sub>.

There is a subindex in object 1010<sub>h</sub> for each *category*. To save all objects of this *category*, the value "65766173<sub>h</sub>" must be written in the subindex.<sup>1</sup> The controller signals the end of the save process by overwriting the value with a "1".

The following table shows which subindex of object 1010<sub>h</sub> is responsible for which *category*.

Subindex	Category
01 <sub>h</sub>	All categories with the exception of 0A <sub>h</sub> (CANopen)

<sup>1</sup> This corresponds to the decimal of 1702257011<sub>d</sub> or the ASCII string `save`.

Subindex	Category
02 <sub>h</sub>	Communication
03 <sub>h</sub>	Application
04 <sub>h</sub>	Customer
05 <sub>h</sub>	Drive
06 <sub>h</sub>	Tuning
0A <sub>h</sub>	CANopen

### 8.5.9 Discarding the saved data

If all objects or one *category* of saved objects is to be deleted, value "64616F6C<sub>h</sub>" must be written in object 1011<sub>h</sub>.<sup>2</sup> The following subindices correspond to a *category* here:

Subindex	Category
01 <sub>h</sub>	All categories (reset to factory settings) with the exception of 06 <sub>h</sub> (Tuning) and 0A <sub>h</sub> (CANopen)
02 <sub>h</sub>	Communication
03 <sub>h</sub>	Application
04 <sub>h</sub>	Customer
05 <sub>h</sub>	Drive
06 <sub>h</sub>	Tuning
0A <sub>h</sub>	CANopen

The saved objects are subsequently discarded; the change does not take effect until after the controller is restarted. You can restart the controller by entering the value "746F6F62<sub>h</sub>" in 2800<sub>h</sub>:01<sub>h</sub>.

#### NOTICE



- Objects of *category* 06<sub>h</sub> (Tuning) are determined by Auto setup and are not reset when resetting to factory settings with subindex 01<sub>h</sub> (thereby making it unnecessary to again perform an auto setup). You can reset these objects with subindex 06<sub>h</sub>.
- Objects of *category* 0A<sub>h</sub> (CANopen) are not reset with subindex 01<sub>h</sub>.

### 8.5.10 Verifying the configuration

Object 1020<sub>h</sub> can be used to verify the configuration. It acts as a modification marker similar to common text editors: as soon as a file is modified in the editor, a marker (usually an asterisk) is added.

The entries of object 1020<sub>h</sub> can be written with a date and time and then saved together with all other savable objects with 1010<sub>h</sub>:01.

The entries of 1020<sub>h</sub> are reset to "0" as soon as a savable object (including 1010<sub>h</sub>:0x<sub>h</sub>, except for 1010<sub>h</sub>:01<sub>h</sub> and 1020<sub>h</sub>) is written.

The following sequence makes verification possible:

1. An external tool or master configures the controller.
2. The tool or master sets the value in object 1020<sub>h</sub>.
3. The tool or master activates the saving of all objects 1010<sub>h</sub>:01<sub>h</sub> = 65766173<sub>h</sub>. The date and time in object 1020<sub>h</sub> are also saved.

<sup>2</sup> This corresponds to the decimal of 1684107116<sub>d</sub> or the ASCII string load.

After the controller is restarted, the master can check the value in 1020<sub>h</sub>:01<sub>h</sub> and 1020:01<sub>h</sub>. If one of the values is "0", the object dictionary was changed after the saved values were loaded. If the date or time in 1020 does not correspond to the expected value, objects were probably saved with values other than those that were expected.

## 9 CANopen

You can address the controller using CANopen. The controller can function in a network as a *slave*.

In this chapter, the services of the CANopen communication structure are described. The CANopen messages are individually broken down.

CANopen references: [www.can-cia.org](http://www.can-cia.org)

- *CiA 301 CANopen application layer and communication profile - Application layer and communication profile*, Date: 21.02.2011, Version: 4.2.0
- *CiA 402 Device profile for drives and motion control - Part 1: General definitions*, Date: 14.12.2007, Version: 3.0.0
- *CiA 402 Drives and motion control device profile - Part 2: Operation modes and application data*, Date: 14.12.2007, Version: 3.0
- *CiA 402 Drives and motion control device profile - Part 3: PDO mapping*, Date: 14.12.2007, Version: 3.0
- *CiA 306 Electronic device description - Part 1: Electronic Data Sheet and Device Configuration File*, Date: 08.02.2012, Version: 1.3.5
- *CiA 305 Layer setting services (LSS) and protocols*, Date: 08.05.2013, Version: 3.0.0

### 9.1 General



#### TIP

- Only 11-bit CAN-IDs are currently supported.
- With CANopen, the data are always sent over the bus in little-endian format.

#### 9.1.1 CAN message

CAN messages are described in this chapter; these are written in the following format:

583 | 41 09 10 00 1E 00 00 00

183R | DLC=0

The individual messages are written as follows:

- All numbers are written in hexadecimal notation; due to the abbreviated notation, the leading 0x is omitted.
- Normal data message: The CAN-ID is prefixed to the CAN message; in the above example, the ID 583 (i.e., 583<sub>h</sub> or 1411<sub>d</sub>). The data and the CAN-ID are separated from the data with a pipe character.
- RTR message (remote transmission request): If an R follows the CAN-ID instead of the data, the length of the *DLC* (Download Content) is specified. In the above example, the length of the *DLC* is 0.

### 9.2 CANopen services

The CANopen stack offers the services listed in the following table; more detailed descriptions can be found in the respective chapters.

Default CAN-ID	Service	Description in
000 <sub>h</sub>	Network Management (NMT)	Section <a href="#">Network Management (NMT)</a>
080 <sub>h</sub>	Synchronization Object	Section <a href="#">Synchronization object (SYNC)</a>
080 <sub>h</sub> +Node-ID	Emergency	Section <a href="#">Emergency Object (EMCY)</a>
180 <sub>h</sub> +Node-ID	TX Process Data Objects (PDO)	Section <a href="#">Process Data Object (PDO)</a>
200 <sub>h</sub> +Node-ID	RX Process Data Objects (PDO)	
280 <sub>h</sub> +Node-ID	TX Process Data Objects (PDO)	
300 <sub>h</sub> +Node-ID	RX Process Data Objects (PDO)	

Default CAN-ID	Service	Description in
380 <sub>h</sub> +Node-ID	TX Process Data Objects (PDO)	
400 <sub>h</sub> +Node-ID	RX Process Data Objects (PDO)	
480 <sub>h</sub> +Node-ID	TX Process Data Objects (PDO)	
500 <sub>h</sub> +Node-ID	RX Process Data Objects (PDO)	
580 <sub>h</sub> +Node-ID	TX Service Data Objects (SDO)	Section <u>Service Data Object (SDO)</u>
600 <sub>h</sub> +Node-ID	RX Service Data Objects (SDO)	
700 <sub>h</sub> +Node-ID	BOOT-UP Protocol	Section <u>Boot-Up Protocol</u>
700 <sub>h</sub> +Node-ID	Nodeguarding and Heartbeat	Section <u>Heartbeat and Nodeguarding</u>

The setting for the node-ID can be found in Position of the virtual rotary switch.

### 9.2.1 Network Management (NMT)

The network management follows a master-slave structure. NMT requires a CANopen device in the network that performs the role of the CANopen master.

All other devices have the role of the NMT slave. Each NMT slave can be addressed via its individual node-ID in the range from [1–127]. NMT services can be used to initiate, start, monitor, reset or stop CANopen devices.

In doing so, the controller follows the state diagram shown in the following figure. The "Initialization" state is only reached after switching on or by sending a "Reset Communication" or "Reset Node" NMT command. The "Pre-Operational" state is automatically activated after initialization.

In object 1F80<sub>h</sub>, you can set whether the "Operational" state is automatically switched to afterwards, thereby allowing you to avoid sending an additional NMT command.

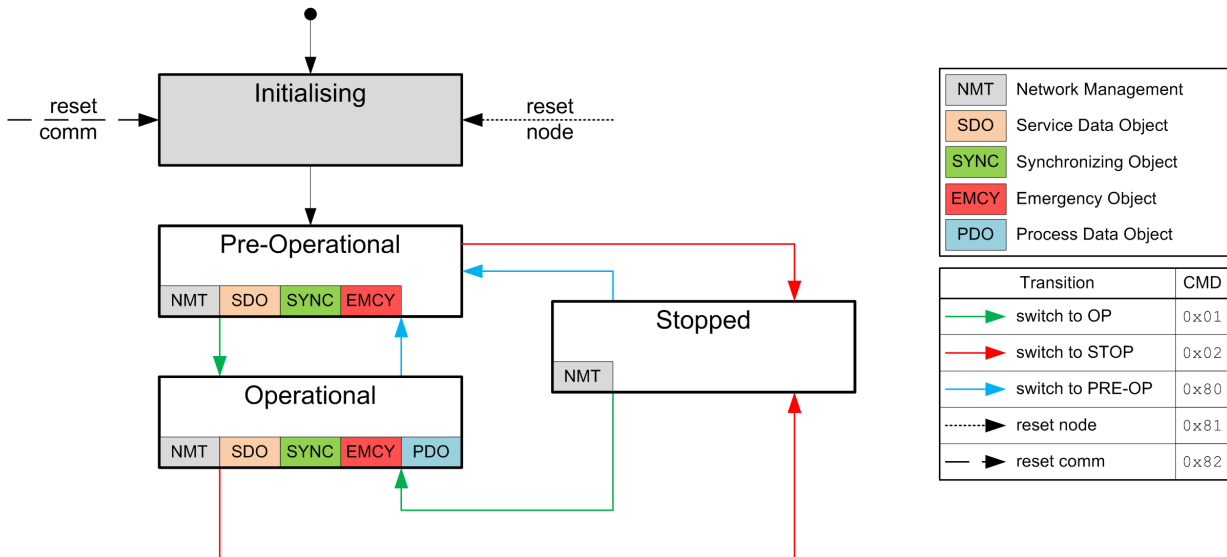

Shown in the following table is an overview of the activity of the services in the respective states.

Note that the *Stopped* state stops communication completely and only permits controller of the NMT state machine.

Service	Initializing	Pre-Operational	Operational	Stopped
PDO			Active	
SDO		Active	Active	
SYNC		Active	Active	
EMCY		Active	Active	



Service	Initializing	Pre-Operational	Operational	Stopped
BOOT-UP	Active			
NMT		Active	Active	Active

The "Network Management" message has CAN-ID 0. A message is always two bytes long and has the following structure:

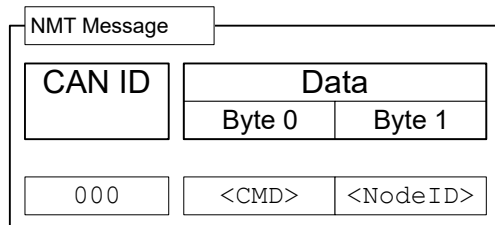

Here, the <CMD> corresponds to one of the following bytes (see also the legend in the figure of the [NMT state diagram](#)):

<CMD>	Meaning
01 <sub>h</sub>	Switch to the "Operational" state
02 <sub>h</sub>	Switch to the "Stop" state
80 <sub>h</sub>	Switch to the "Pre-Operational" state
81 <sub>h</sub>	Reset Node
82 <sub>h</sub>	Reset Communication

Completely restart the controller with the "Reset Node" command. Use the "Reset Communication" command to reset the CANopen settings and restart the communication.

The value for <Node-ID> can be 00<sub>h</sub>; in this case, the NMT command applies for all devices on the CAN bus (broadcast). If a number not equal to zero is used, only the device with the corresponding node-ID is addressed.

Example: If all devices on the CAN bus are to be switched to the "Stop" operating state, a broadcast with the "Switch to the Stop state" command can be used. The NMT message is structured as follows:

000 | 02 00

If only the device with node-ID 42 is to be completely restarted, the following CAN message is to be sent:

000 | 01 2A

### 9.2.2 Synchronization object (SYNC)

The Synchronization object is used to simultaneously validate the time of PDO data for all devices on the bus. The sync message is structured as follows:

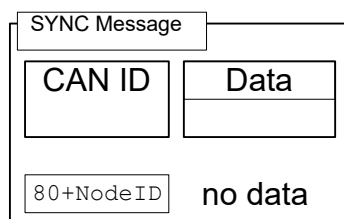

For SYNC operation, transmission mode (Transmission Type) 0 is usually used for the RX-PDOs (data are valid with the next SYNC); for TX-PDOs, a transmission mode between 1 and 240 is selected. (Details: see chapter [Process Data Object \(PDO\)](#)).

After receiving a SYNC message, there is a time window ("synchronous window") within which PDO messages can be sent and received. If the time of the window has elapsed, all devices must stop sending PDOs. The "synchronous window length" can be set in microseconds in object `1007h:00h`.

A typical CAN-SYNC operation is divided into four phases (see also the following figure):

1. The SYNC message is received. The previously received RX-PDO data are thereby copied to the object dictionary (if present). At that time, the data are also sampled and copied to the TX-PDOs and the sending of these messages initiated.
2. The TX-PDOs are then sent by all slaves on the bus.
3. Afterwards, the PDOs are sent by the CANopen master. After the "synchronous window length" time has elapsed, no further PDOs are permitted.
4. SDO messages can be exchanged at the latest when the "synchronous window" is closed again.

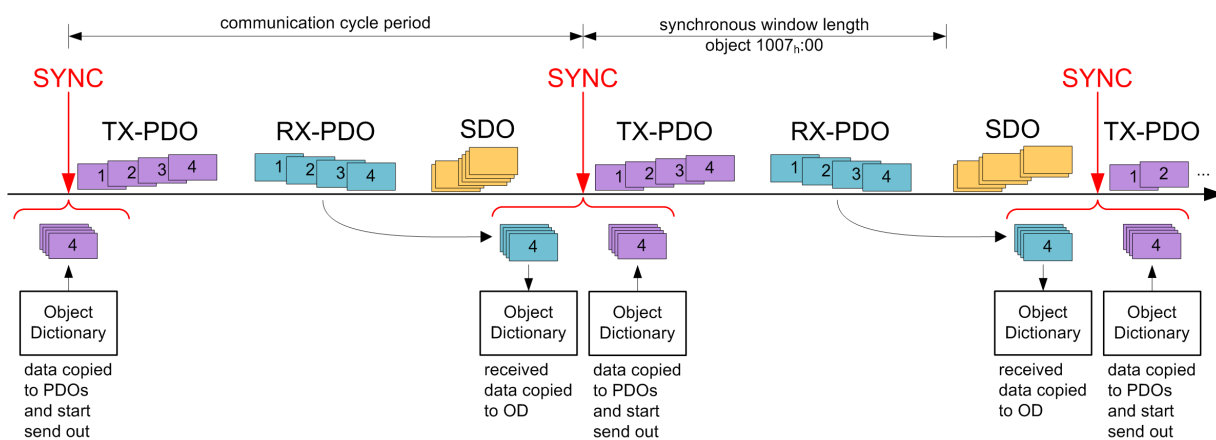

If the *Sync Producer* supports a *Sync Counter*, the sync message receives an additional 1-byte numerical value. This counter is increased by the value "1" per sent sync message and is reset each time the value `1019h Synchronous Counter Overflow Value` is reached.

For each *TX-PDO*, a start value of the *Sync Counter* can be defined in subindex `06h` of the corresponding communication parameter (e.g., in `1800h:06h`) beginning with which the *slave* is to respond to the sync for the first time and send the PDO. The function is not activated until a value greater than 1 is set in `1019h`.

### 9.2.3 Emergency Object (EMCY)

A message of type "Emergency" is sent whenever an error occurs in the controller that was not caused by an SDO access. This service is unconfirmed and is sent with CAN-ID `80h+Node-ID`.

The emergency message is structured as follows:

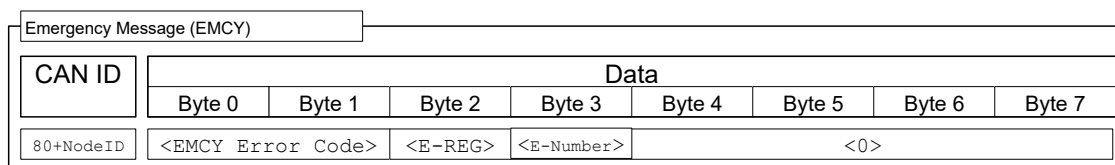

A total of three error codes are transferred here:

- the "Emergency Error Code" (<EMCY Error Code>)
- the content of the "Error Register" object (`1001h`), E-REG
- the "Error Number" (E-Number)

### 9.2.3.1 Error handling

A module for error handling processes all errors that occur internally. Each error is classified into an error class.

Each error that occurs is handled as follows:

1. The bit that belongs to the error in the "Error Register" object (1001<sub>h</sub>) is set.
2. Three pieces of information are then written together in the "Pre-defined Error Field" object (1003<sub>h</sub>;01):
  - The *Emergency Error Code*
  - The *Error Register*
  - The manufacturer-specific error code
3. If no further errors are pending, the following message is sent:  
 80 + Node-ID | 00 00 E-REG E-Number 00 00 00 00

In object 1029<sub>h</sub>, you can configure whether and how the controller is to change its *NMT state* in case of an error.

### 9.2.4 Service Data Object (SDO)

A "Service Data Object" permits read or write access of the object dictionary.

In the following, the owner of the object dictionary is referred to as the "server"; the CAN node – which wants to request or write the data – is referred to as the "client".

An "upload" refers to the reading of a value of an object from the object dictionary; a "download" refers to the writing of a value in the object dictionary. In addition, the following abbreviations are used in the diagrams:

- <IDX>: Index of the object that is to be read or written in the object dictionary; the LSB of the index is in byte 1 here. Example: The statusword of the controller has index 6041<sub>h</sub>; byte 1 is then written with 41<sub>h</sub> and byte 2 with 60<sub>h</sub>. With Expedited Transfer, the SDO answer contains the same index as that of the request.
- <SUBIDX>: Subindex of the object in the object dictionary from 00<sub>h</sub> to FF<sub>h</sub>. With Expedited Transfer, the answer of the SDO message of the controller also contains the subindex of the request.

Because CAN messages of type SDO contain a large amount of metadata, you should only use SDO messages to configure the controller. Should it be necessary to cyclically exchange data during running operation, use CANopen messages of type PDO (see subsection Process Data Object).

The SDO transfers are divided into three types of access:

- "expedited transfer" for transferring objects with up to four bytes.
- "normal transfer" for transferring any number of bytes, whereby each CAN message is confirmed individually.
- "block transfer" is also for any number of bytes; here, a given block of CAN tickets is confirmed at once.

An SDO message is sent to CAN-ID 600<sub>h</sub> + node-ID, the answer comes from CAN-ID 580<sub>h</sub> + node-ID.

#### 9.2.4.1 Expedited Transfer

This method is used to write (download) or read (upload) values in objects of type (UN)SIGNED8, INTEGER16 oder INTEGER32 in the object dictionary. This service is confirmed, i.e., each access is answered with data, with a confirmation or with an error message.

##### SDO Download

An expedited SDO message for writing data in the object dictionary of the server is structured as follows:

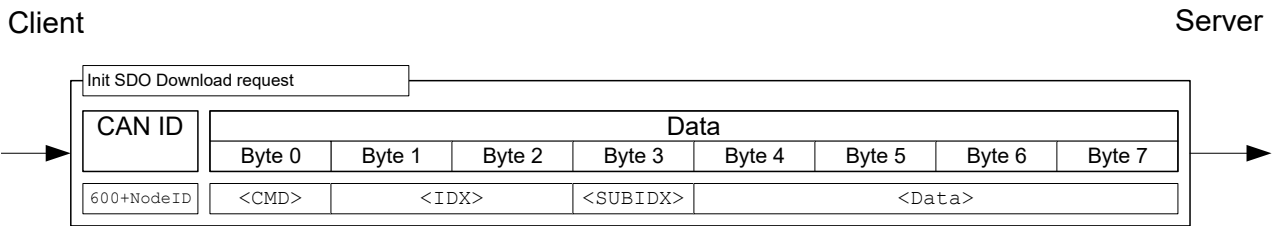

Here, the <CMD> byte is dependent on the length of the data that are to be written. <CMD> can be one of the following values:

- 1 byte data length: 2F<sub>h</sub>
- 2 byte data length: 2B<sub>h</sub>
- 3 byte data length: 27<sub>h</sub>
- 4 byte data length: 23<sub>h</sub>

The <Data> field is written with the data that are to be written; the LSB of the data is entered in byte 4.

The answer from the server is either a confirmation of the write operation or an error message (structure of the messages: see following figure). In the latter case, the reason for the error is also sent with the data (see list of the SDO error messages in section [SDO error messages](#)).

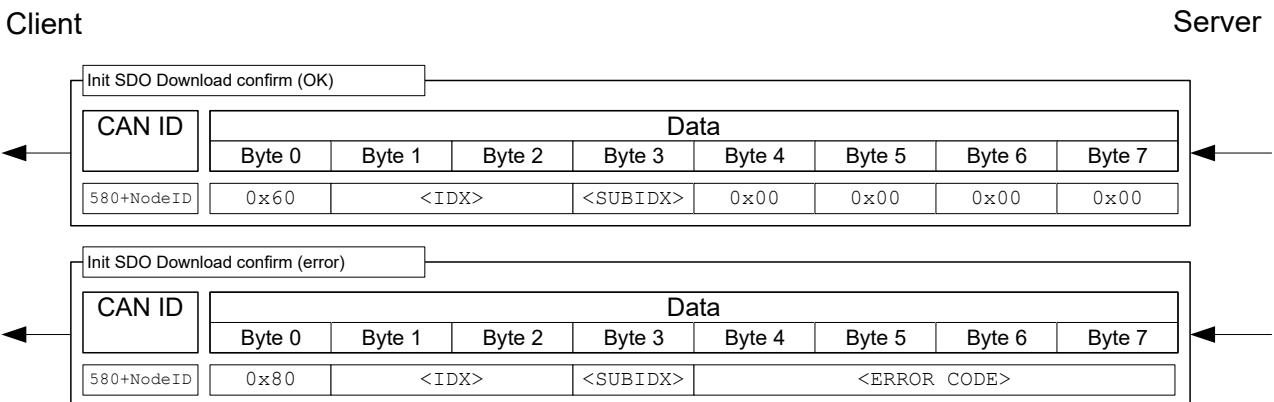

**Example:** Set object 607A<sub>h</sub>:00<sub>h</sub> (target position, SIGNED32) to value 3E8<sub>h</sub> (=1000<sub>d</sub>) of a controller with node-ID 3:

```
603 | 23 7A 60 00 E8 03 00 00
```

Where

- Byte 1 (23<sub>h</sub>): SDO expedited download, 4 bytes of data (SIGNED32)
- Bytes 2 and 3 (7A<sub>h</sub> 60<sub>h</sub>): index of object is 607A<sub>h</sub>
- Byte 4 (00<sub>h</sub>): subindex of object is 00<sub>h</sub>
- Bytes 5 to 8 (E8<sub>h</sub> 03<sub>h</sub> 00<sub>h</sub> 00<sub>h</sub>): value of object: 000003E8<sub>h</sub>

If successful, the controller responds with this message:

```
583 | 60 7A 60 00 00 00 00 00
```

### SDO upload

A CAN message for reading an object from the object dictionary has the following structure:

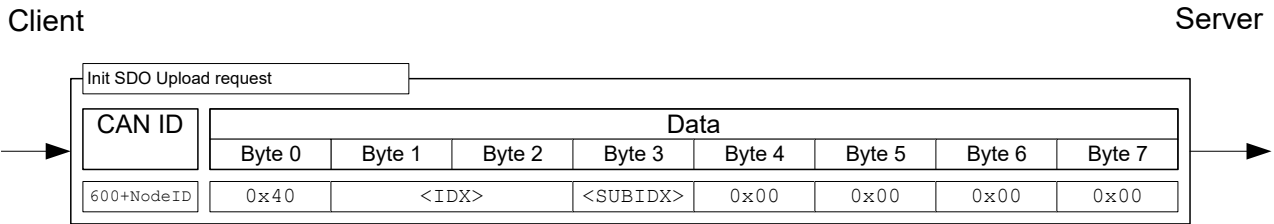

The server responds with one of the following messages.

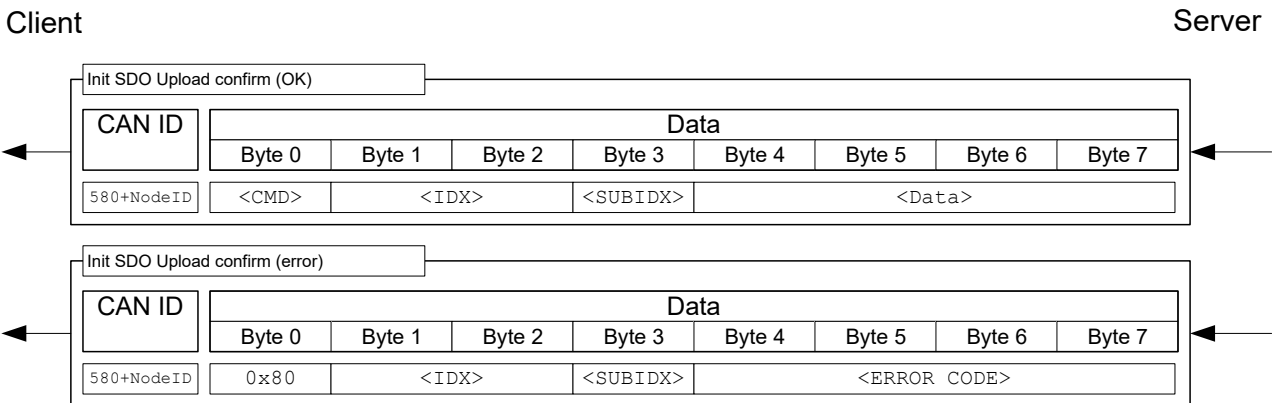

The length of the data is encrypted in the <CMD> of the answer:

1 byte data length:	4F <sub>h</sub>
2 byte data length:	4B <sub>h</sub>
3 byte data length:	47 <sub>h</sub>
4 byte data length:	43 <sub>h</sub>

The LSB of the data is again in byte 4 here.

In case of an error, the reason for the error is also specified in the data (see list of SDO error messages in [SDO error messages](#)).

**Example:** To read the "statusword" object (6041<sub>h</sub>:00) from the object dictionary, it suffices to send the following message (always 8 bytes):

```
603 | 40 41 60 00 00 00 00 00
```

The controller generally responds with the following message:

```
583 | 4B 41 60 00 40 02 00 00
```

Where

- Byte 1 (4B<sub>h</sub>): SDO expedited upload, 2 bytes of data (UNSIGNED16)
- Bytes 2 and 3 (41<sub>h</sub> 60<sub>h</sub>): index of object is 6041<sub>h</sub>
- Byte 4 (00<sub>h</sub>): subindex of object is 00<sub>h</sub>

- Bytes 5 to 6 (40<sub>h</sub> 02<sub>h</sub>): value of object: 0240<sub>h</sub>
- Bytes 7 to 8 (00<sub>h</sub> 2<sub>h</sub> h h): empty. An SDO message always consists of 8 bytes.

### 9.2.4.2 Normal Transfer

Unlike "expedited" CANopen transfer, "normal transfer" is not limited to maximum four bytes. With this type of transfer, the content of multiple messages is grouped together with respect to content; such a block of messages is referred to in the following as a "transfer". Each message within a transfer is confirmed individually here.

**NOTICE**



If your CANopen master does not support normal transfer, there is another way to access objects of data type String: each string can be read out character by character with an SDO upload to subindex 1 and the following subindices.

### SDO upload

Shown in the following figure is the procedure for an "SDO upload" (client requests that the content of an object be sent to it). The transfer is broken down into two phases: an initialization phase and a transfer phase.

As with an "expedited transfer", the upload begins with the client sending an "Init SDO Update" to the server (see following figure).

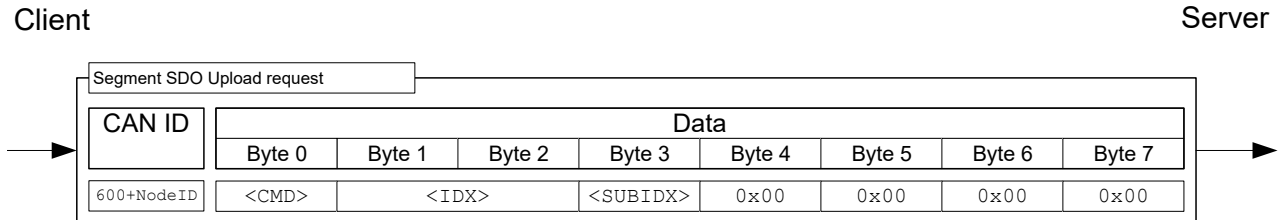

The answer for a "normal transfer" does not contain the quantity of bytes to be received encoded in the <CMD>. It is instead entered in the data range as can be seen in the following figure in the <DATA LENGTH> area.

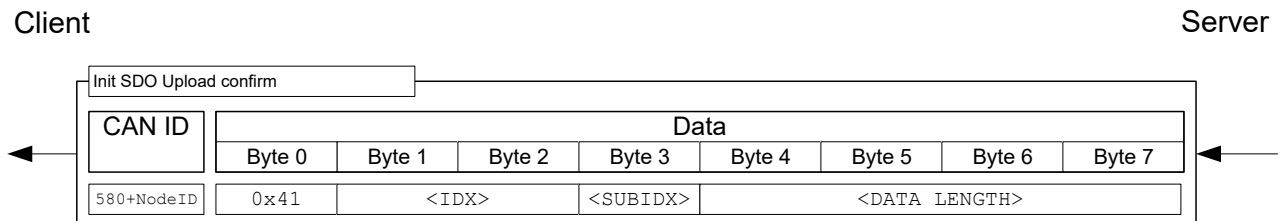

The initialization is thereby concluded; all that remains is the upload of the data. A data packet is requested with the following SDO request:

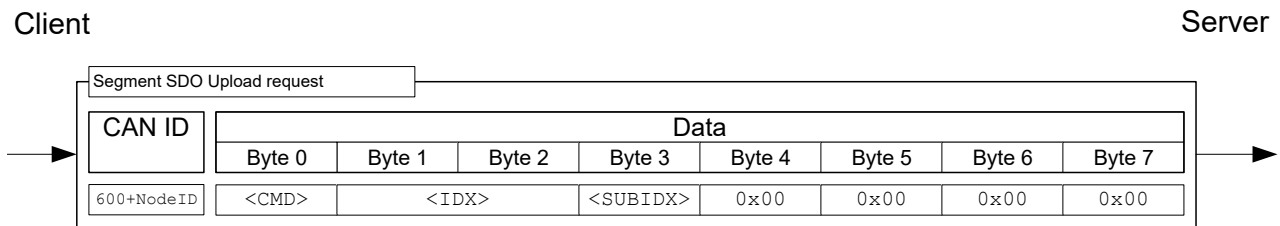

Byte 0 with command <CMD> is structured as follows:

The bit with designation  $t$  alternates with each request ("toggle bit"). It begins each transfer with 0, even if the previous transfer was aborted.

The controller responds to the above message with the data, whereby the message is structured as follows:

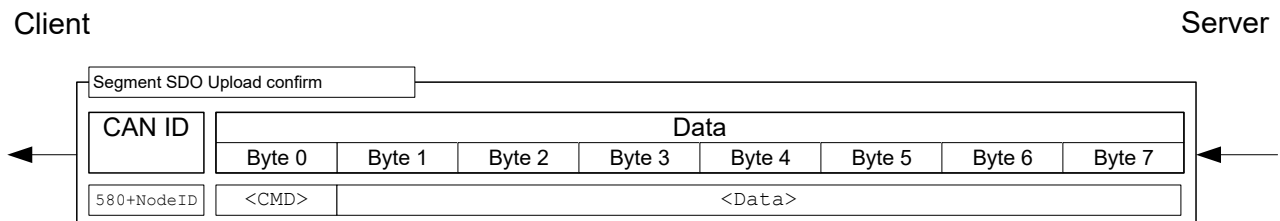

Byte 0 with <CMD> is structured as follows:

The bits have the following meaning here:

**$t$  (toggle bit)**

The bit alternates with each message sequence; it does not change within a sequence between "request" and "response".

**$n$  (number of bytes)**

These three bits specify how many bytes contain *no* data. Example: If bits 2 and 1 are set to 0 and bit 3 is set to 1, then  $011_b = 03_d$  bytes are not valid. This, in turn, means that byte 1 to byte 4 contain allowed values and byte 5 to byte 7 should be disregarded.

**$c$  (more segments)**

If no further SDO segments are sent and this is the last segment, the bit is set to 1.

**Example:** In this example, the "Manufacturer Software Version" object ( $100A_h$ ) is to be read. The node-ID of the node in this example is 3.

The corresponding SDO message sequence is listed in the following table. The string that is to be read out varies from controller to controller.

COB-ID	Data	Description
603 <sub>h</sub>	40 0A 10 00 00 00 00 00	Init Upload; Index: 100A <sub>h</sub> ; Subindex: 00
583 <sub>h</sub>	41 0A 10 00 11 00 00 00	Init Upload; Size: indicated; transfer type: normal; Num of bytes: 17; Index: 100A <sub>h</sub> ; Subindex: 00
603 <sub>h</sub>	60 0A 10 00 00 00 00 00	Upload Segment Req.; Toggle bit: not set
583 <sub>h</sub>	00 46 49 52 2D 76 31 37	Upload Segment Conf.; More segments: yes; num of bytes: 7; Toggle bit: not set
603 <sub>h</sub>	70 0A 10 00 00 00 00 00	Upload Segment Req.; Toggle bit: set
583 <sub>h</sub>	10 34 38 2D 42 35 33 38	Upload Segment Conf.; More segments: yes; num of bytes: 7; Toggle bit: set
603 <sub>h</sub>	60 0A 10 00 00 00 00 00	Upload Segment Req.; Toggle bit: not set
583 <sub>h</sub>	09 36 36 32 00 00 00 00	Upload Segment Conf.; More segments: no (last segment); num of bytes: 3; Toggle bit: not set

46 49 52 2D 76 31 37 34 38 2D 42 35 33 38 36 36 32

This corresponds to string: "FIR-v1748-B538662"

### Aborting the SDO transfer

Both the server and the client are authorized to abort the current transfer. To do this, an "Abort SDO Transfer" must be sent; this is depicted in the following.

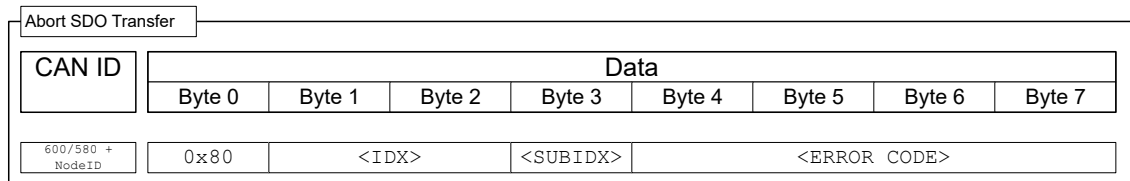

After receiving the message, the SDO transfer is considered ended; the service is not confirmed.

A new SDO transfer must then be started from the very beginning. Transfer of the <ERROR CODE> is optional; the controller does not evaluate the code.

### 9.2.4.3 SDO error messages

In case of an error, an error number specifying the reason for the error is also sent in the data area.

Error Code	Description
05030000 <sub>h</sub>	<i>toggle bit not changed</i> : Valid only with "normal transfer" or "block transfer". The bit, which is to alternate after each transfer, did not change its state.
05040001 <sub>h</sub>	<i>command specifier unknown</i> : Byte 0 of the data block contains a command that is not allowed.
06010000 <sub>h</sub>	<i>unsupported access</i> : If "complete access" was requested via CAN over EtherCAT (CoE) (is not supported.)
06010002 <sub>h</sub>	<i>read only entry</i> : An attempt was made to write to a constant or read-only object.
06020000 <sub>h</sub>	<i>object not existing</i> : An attempt was made to access a non-existing object (index incorrect).
06040041 <sub>h</sub>	<i>object cannot be pdo mapped</i> : An attempt was made to map an object in the PDO for which that is not permissible.



Error Code	Description
06040042 <sub>h</sub>	<i>mapped pdo exceed pdo</i> : If the desired object were to be attached to the PDO mapping, the 8 bytes of the PDO mapping would be exceeded.
06070012 <sub>h</sub>	<i>parameter length too long</i> : An attempt was made to write to an object with too much data; for example, with <CMD>=23 <sub>h</sub> (4 bytes) to an object of type Unsigned8, <CMD>=2F <sub>h</sub> would be correct.
06070013 <sub>h</sub>	<i>parameter length too short</i> : An attempt was made to write to an object with too little data; for example, with <CMD>=2F <sub>h</sub> (1 byte) to an object of type Unsigned32, <CMD>=23 <sub>h</sub> would be correct.
06090011 <sub>h</sub>	<i>subindex not existing</i> : An attempt was made to access an invalid subindex of an object; the index, on the other hand, would exist.
06090031 <sub>h</sub>	<i>value too great</i> : Some objects are subject to restrictions in the size of the value; in this case, an attempt was made to write an excessively large value to the object. For example, the "Pre-defined error field: Number of errors" object for 1003 <sub>h</sub> :00 may only be set to the value "0"; all other numerical values result in this error.
06090032 <sub>h</sub>	<i>value too small</i> : Some objects are subject to restrictions in the size of the value. In this case, an attempt was made to write a value that is too small to the object.
08000000 <sub>h</sub>	<i>general error</i> : General error that does not fit in any other category.
08000022 <sub>h</sub>	<i>data cannot be read or stored in this state</i> : The parameters of the PDOs may only be changed in the "Stopped" or "Pre-Operational" state. Write access of objects 1400 <sub>h</sub> to 1407 <sub>h</sub> , 1600 <sub>h</sub> to 1607 <sub>h</sub> , 1800 <sub>h</sub> to 1807 <sub>h</sub> and 1A00 <sub>h</sub> to 1A07 <sub>h</sub> is not permissible in the "Operational" state.

## 9.2.5 Process Data Object (PDO)

A message that only contains process data is referred to as a "Process Data Object" (PDO). The PDO is intended for data that need to be exchanged cyclically.

The idea behind a PDO message is to remove all additional information (index, subindex and data length) from a CAN message and to only fill the CAN message with data. The source and target information for the PDO are stored separately in the so-called PDO mapping.

PDOs can only be used if the NMT state machine is in the "Operational" state (see section [Network Management \(NMT\)](#)); the PDOs must be configured in the "Pre-Operational" NMT state.

The controller supports a total of 8 independent PDO mappings; each corresponding PDO message can have a maximum of eight bytes (=64 bit) of user data. It is thereby possible to, for example, transfer two UNSIGNED32 values or one UNSIGNED32 and one UNSIGNED08; the message does not need to use all eight data bytes.

The PDOs differ yet again in the configuration in the send and receive configuration. The receive configuration describes the processing for PDO messages that are sent, and the send configuration describes the PDO messages that are to be sent.

### 9.2.5.1 RX configuration

To configure an RX-PDO, you must take into account three object categories in the object dictionary:

- The objects that describe the functionality of the mapping.
- The objects that describe the content of the mapping.
- The objects that are to receive the received data.

#### Configuration of the functionality (communication parameter)

The configuration of the first mapping is stored in the subindices of object 1400<sub>h</sub>. The second mapping is configured in 1401<sub>h</sub> and so on. In the following, we refer to 140N<sub>h</sub>. Here, the configuration affects the COB-ID of the PDO message and the transfer type.

Objects 140N<sub>h</sub> have only three subindices:

- Subindex 0 (max. subindex): Total number of subindices
- Subindex 1 (COB-ID): The COB-ID is stored here. For PDO mappings 1–4 (1600<sub>h</sub>–1603<sub>h</sub>), the CAN-ID is fixed depending on the node-ID and only the valid bit (bit 31) can be set in the COB-ID. From 1604<sub>h</sub>–1607<sub>h</sub>, the CAN-ID can be set independently (with the restriction that it not be used by other services, see table at the start of chapter [CANopen services](#)) as can the valid bit. The change of a COB-ID does not take effect until *after* the controller or communication is restarted (see [Network Management \(NMT\)](#)).

Mapping	COB-ID
1600 <sub>h</sub>	200 <sub>h</sub> + Node-ID
1601 <sub>h</sub>	300 <sub>h</sub> + Node-ID
1602 <sub>h</sub>	400 <sub>h</sub> + Node-ID
1603 <sub>h</sub>	500 <sub>h</sub> + Node-ID
1604 <sub>h</sub>	xxx <sub>h</sub> + Node-ID
1605 <sub>h</sub>	xxx <sub>h</sub> + Node-ID
1606 <sub>h</sub>	xxx <sub>h</sub> + Node-ID
1607 <sub>h</sub>	xxx <sub>h</sub> + Node-ID

- Subindex 2 (transmission type): A number is stored in this subindex that defines the time at which the received data become valid. The number and the corresponding meaning can be found in the following table.

140N <sub>h</sub> :02 <sub>h</sub>	Meaning
00 <sub>h</sub> -F0 <sub>h</sub>	Synchronous: The data are buffered and not until the next SYNC message is received do they become valid and are they taken over into the object dictionary.
F1 <sub>h</sub> -FD <sub>h</sub>	Reserved
FE <sub>h</sub> , FF <sub>h</sub>	Asynchronous: The data become valid when the PDO message is received and are taken over into the object dictionary.

### Content of a mapping

The configuration of the content of a mapping is structured as follows (see also the following figure as an example):

- All subindices of a configuration object belong together. Thus, 1600<sub>h</sub> with all subindices describes the first mapping, 1601<sub>h</sub> the second RX-PDO mapping, etc.
- Subindex 00<sub>h</sub> specifies how many objects are in a mapping. It simultaneously specifies how many of the subindices are valid. If object 1600<sub>h</sub>:00<sub>h</sub> is set to "0", RX mapping is thereby completely switched off. In the example shown in the following figure, two objects are thus mapped; object 1600<sub>h</sub>:03<sub>h</sub> and 1600<sub>h</sub>:04<sub>h</sub> is, therefore, not active (shown in gray).
- Each subindex from 1600<sub>h</sub>:01<sub>h</sub> to 1600<sub>h</sub>:0F<sub>h</sub> describes one target of the mapping sequentially and without gaps. The index, subindex and bit length are thereby encoded. Example from the following figure: The first two bytes of the message are to be written in object 6040<sub>h</sub>:00<sub>h</sub>. In hexadecimal notation, the content of 1600<sub>h</sub>:01<sub>h</sub> then consists of <Index><Subindex><Bit length> or 60400010. The second mapping (1600<sub>h</sub>:02<sub>h</sub>) contains the entry 607A0020. Thus, it maps the following four bytes (=20<sub>h</sub>Bit) in object 607A<sub>h</sub>:00<sub>h</sub>

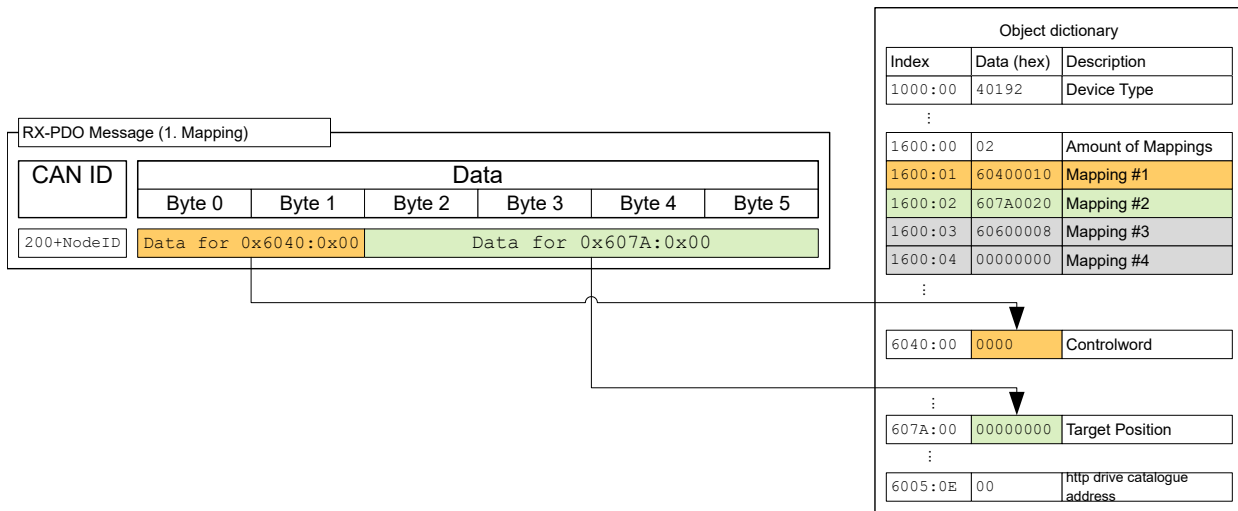

### Dummy objects

You can configure RX-PDOs so that more than one node can respond. In this case, it may be desirable for only part of the data contained in the PDO to be evaluated in one of the devices. For data not used locally, you can include a dummy object of one of the supported data types in the mapping of the PDO:

Index	Data type
0002 <sub>h</sub>	INTEGER8
0003 <sub>h</sub>	INTEGER16
0004 <sub>h</sub>	INTEGER32
0005 <sub>h</sub>	UNSIGNED08
0006 <sub>h</sub>	UNSIGNED16
0007 <sub>h</sub>	UNSIGNED32

### 9.2.5.2 TX configuration

To configure a TX-PDO, you must take into account three object categories in the object dictionary:

- The objects that describe the functionality of the mapping.
- The objects that describe the content of the mapping.
- The objects that are to receive the data that are to be sent.

Also note that the time at which the data are copied to the TX-PDO message and the time of sending do not need to be the same (dependent on mode).

#### Configuration of the functionality (communication parameter)

The configuration of the functionality of the first mapping is stored in the subindices of object 1800<sub>h</sub>. The second mapping is configured in 1801<sub>h</sub> and so on. In the following, we refer to 180N<sub>h</sub>. Here, the configuration affects the COB-ID of the PDO message and the transfer type.

Objects 180N<sub>h</sub> have the following subindices:

- Subindex 0 (max. subindex): Total number of subindices
- Subindex 1 (COB-ID): The COB-ID is stored here. For PDO mappings 1–4 (1A00<sub>h</sub>–1A03<sub>h</sub>), the CAN-ID is fixed depending on the node-ID and only the valid bit (bit 31) can be set in the COB-ID. From 1A04<sub>h</sub>–1A07<sub>h</sub>, the CAN-ID can be set independently (with the restriction that it not be used by other services, see table at the start of chapter [CANopen services](#)) as can the valid bit. A COB-ID change does not take effect until *after* the controller or communication is restarted (see [Network Management \(NMT\)](#)).

Mapping	COB-ID
1A00 <sub>h</sub>	180 <sub>h</sub> + Node-ID
1A01 <sub>h</sub>	280 <sub>h</sub> + Node-ID
1A02 <sub>h</sub>	380 <sub>h</sub> + Node-ID
1A03 <sub>h</sub>	480 <sub>h</sub> + Node-ID
1A04 <sub>h</sub>	xxx <sub>h</sub> + Node-ID
1A05 <sub>h</sub>	xxx <sub>h</sub> + Node-ID
1A06 <sub>h</sub>	xxx <sub>h</sub> + Node-ID
1A07 <sub>h</sub>	xxx <sub>h</sub> + Node-ID

- Subindex 2 (transmission type): A number is stored in this subindex that defines the time at which the data are to be copied into the PDO message and when this is to be sent. The number and the corresponding meaning can be found in the following table. Below, we refer to an *Event* that can trigger the copying and/or sending of the data. This *Event* consists of three events, which can be considered independently of one another:
  - The NMT state machine is switched to "operational".
  - The current data have changed with respect to the last PDO message.
  - The *Event Timer* has expired (see 180N<sub>h</sub>:5).

If the *Event Timer* is used, it is handled independently of the changes; the *Event Timer* is not restarted until the current event timer expires, not because of another *Event*.

180N <sub>h</sub> :02 <sub>h</sub>	Meaning
0	Synchronous (acyclic): The data are copied to the TX-PDO upon arrival of the SYNC but are not sent until the <i>Event</i> .
01 <sub>h</sub> -F0 <sub>h</sub>	Synchronous (cyclic): The data are copied upon arrival of the nth SYNC message and are sent immediately thereafter (n corresponds to the number 1 to 240, transmission type "1" sends the new data on each SYNC).
F1 <sub>h</sub> -FB <sub>h</sub>	Reserved
FC <sub>h</sub>	RTR-Only (synchronous): The data are copied upon arrival of each SYNC message but are sent only upon request with an RTR message.
FD <sub>h</sub>	RTR-Only (event-driven): The data are copied to the TX-PDO message upon receipt of an RTR message and sent immediately thereafter.
FE <sub>h</sub> , FF <sub>h</sub>	The data are copied upon arrival of the <i>Event</i> and sent immediately.

- Subindex 3 (inhibit time): This subindex contains a time lock in 100 μs steps (see following figure). This can be used to set a time that must elapse after the sending of a PDO before the PDO is sent another time. This time only applies for asynchronous PDOs. This is intended to prevent PDOs from being sent continuously if the mapped object constantly changes.
- Subindex 4 (compatibility entry): This subindex has no function and exists only for compatibility reasons.
- Subindex 5 (event timer): This time (in ms) can be used to trigger an *Event* which handles the copying of the data and the sending of the PDO.
- Subindex 6 (sync start value): Here, the start value of the *Sync Counter* is entered beginning with which the *slave* is to initially respond to the sync and send the PDO. Not globally activated until a value greater than 1 is set in 1019h Synchronous Counter Overflow Value.

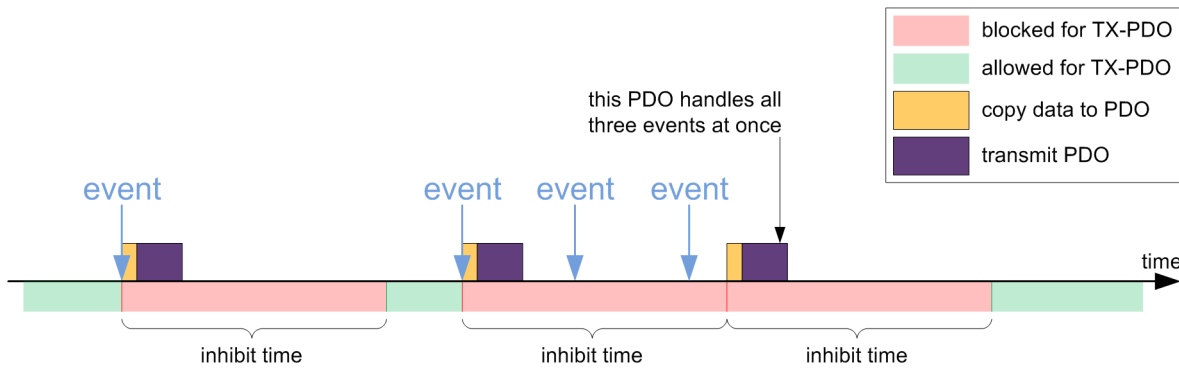

### Content of a mapping

The configuration of the content of a mapping is structured as follows (see the following figure as an example):

- All subindices of a configuration object belong together. Thus, 1A00<sub>h</sub> with all subindices describes the first mapping, 1A01<sub>h</sub> the second TX-PDO mapping, etc.
- Subindex 00 specifies how many objects are in a mapping. It simultaneously specifies how many of the subindices are valid. If object 1A00<sub>h</sub>:00<sub>h</sub> is set to "0", TX mapping is thereby completely switched off. In the following example, two objects are thereby mapped in entries 1A00<sub>h</sub>:01<sub>h</sub> – 1A00<sub>h</sub>:02<sub>h</sub>. The objects in entries 1A00<sub>h</sub>:03<sub>h</sub> – 1A00<sub>h</sub>:04<sub>h</sub> are, thus, not mapped (shown in gray).
- Each subindex from 1A00<sub>h</sub>:01<sub>h</sub> to 1A00<sub>h</sub>:0F<sub>h</sub> respectively describes sequentially and without gaps (dummy objects can be used for gaps) one source of the mapping. The index, subindex and bit length are thereby encoded. Example from the following figure: The first two bytes of the message are to be read from object 6041<sub>h</sub>:00<sub>h</sub>. In hexadecimal notation, the content of 1A00<sub>h</sub>:01<sub>h</sub> then consists of <Index><Subindex><Bit Length>, or 60410010. The second mapping (1A00<sub>h</sub>:02<sub>h</sub>) contains the entry 60640020. Thus, it maps the following four bytes (corresponds to 32 bits) from object 6064<sub>h</sub>:00<sub>h</sub> in the TX-PDO message.

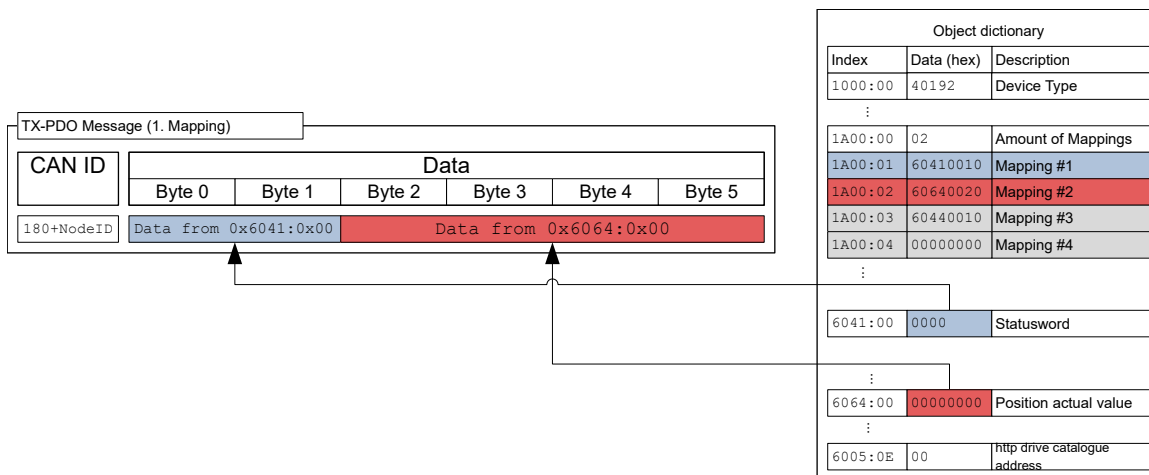

### 9.2.5.3 Presetting

The following configuration is preset:

#### RX-PDO

1. Mapping (CAN-ID: 200<sub>h</sub> + Node-ID):

- 6040<sub>h</sub>:00<sub>h</sub> (controlword)
- 6060<sub>h</sub>:00<sub>h</sub> (mode of operation)

2. Mapping (CAN-ID: 300<sub>h</sub> + Node-ID):

- 607A<sub>h</sub>:00<sub>h</sub> (target position)
  - 6081<sub>h</sub>:00<sub>h</sub> (profile velocity)
3. Mapping (CAN-ID: 400<sub>h</sub> + Node-ID): object 6042<sub>h</sub>:00<sub>h</sub> (vl target velocity)
  4. Mapping (CAN-ID: 500<sub>h</sub> + Node-ID): object 60FE<sub>h</sub>:01<sub>h</sub> (digital outputs)

**TX-PDO**

1. Mapping (CAN-ID: 180<sub>h</sub> + Node-ID):
  - 6041<sub>h</sub>:00<sub>h</sub> (statusword)
  - 6061<sub>h</sub>:00<sub>h</sub> (Modes Of Operation Display)
2. Mapping (CAN-ID: 280<sub>h</sub> + Node-ID): 6064<sub>h</sub>:00<sub>h</sub> (Position actual value)
3. Mapping (CAN-ID: 380<sub>h</sub> + Node-ID): 6044<sub>h</sub>:00<sub>h</sub> (vl velocity actual value)
4. Mapping (CAN-ID: 480<sub>h</sub> + Node-ID): object 60FD<sub>h</sub>:00<sub>h</sub> (digital inputs)

**9.2.5.4 Changing PDO mapping**

You change the PDO mapping in the "Pre-operational" NMT state as follows:

1. Deactivate the PDO by setting the *Valid Bit* (bit 31) of subindex 01h of the corresponding communication parameter (e.g., 1400<sub>h</sub>:01<sub>h</sub>) to "1".
2. Deactivate the mapping by setting subindex 00h of the corresponding mapping parameter (e.g., 1600<sub>h</sub>:00<sub>h</sub>) to "0".
3. Change the mapping in the desired subindices (e.g., 1600<sub>h</sub>:01<sub>h</sub>).
4. Activate the mapping by writing the number of objects that are to be mapped in subindex 00h of the corresponding mapping parameter (e.g., 1600<sub>h</sub>:00<sub>h</sub>).
5. Activate the PDO by setting bit 31 of subindex 01h of the corresponding communication parameter (e.g., 1400<sub>h</sub>:01<sub>h</sub>) to "0".
6. Store the configuration by writing the value "65766173h" in 1010<sub>h</sub>:03<sub>h</sub>.

**9.2.6 Boot-Up Protocol**

If the CAN slave reaches the "Pre-Operational" NMT state (see following figure), the following message is sent to signal operational readiness.

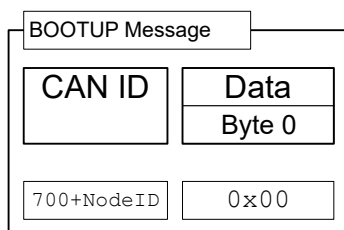

This service is unconfirmed; there is no response.

**NOTICE**



The boot loader sends its own boot-up message. This can be suppressed, see object `2007h:00`

### 9.2.7 Heartbeat and Nodeguarding

With the "Heartbeat" and "Nodeguarding" services (often also referred to as "Lifeguarding"), switched-off or hung devices on the CAN bus can be found. For this purpose, the NMT master cyclically requests a message with the current NMT state of the slave (Nodeguarding).

The alternative is that each slave sends a message unprompted and cyclically (Heartbeat). A combination of Nodeguarding and Heartbeat is not permissible. Furthermore, it is recommended that Heartbeat be given preference over Nodeguarding, as Nodeguarding results in a higher load on the CAN bus.

#### 9.2.7.1 Nodeguarding

This service is based on the fact that the NMT master sends an RTR message with CAN-ID `700h + node-ID` to the respective slave.

The slave must then send a message as response; this message is structured as follows. Bit 7 alternates here on each transfer, thereby allowing one to determine if a message was lost. Entered in bits 6 to 0 is the current NMT status of the slave.

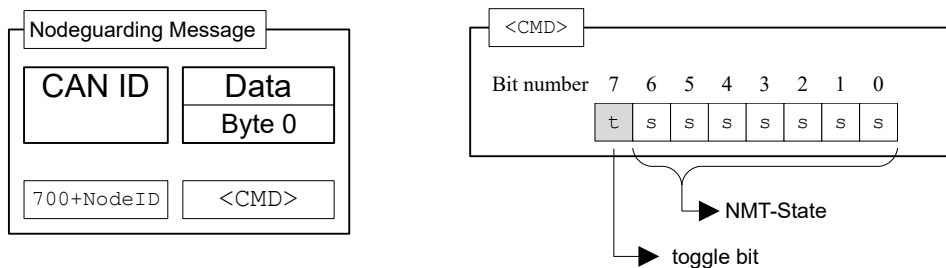

With Nodeguarding, there exist three time intervals (see also the following figure):

- *guard time*: The time between two RTR messages. This can be different for each CAN node and is stored in the slave in object `100Ch:00` (unit: milliseconds)
- *live time factor*: A multiplier for the *guard time*; this is stored in the CAN slave in object `100Dh:00` and can be different for each slave on the CAN bus.
- *possible live time*: The time produced by multiplying *guard time* and *live time factor*.

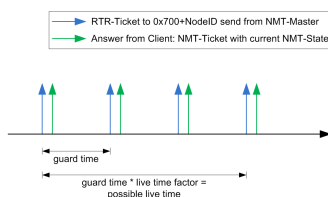

The following conditions are checked during Nodeguarding:

- The NMT master must send the RTR request within the "possible live time".
- The slave must send the response to the RTR request within the "possible live time".

- The slave must respond with its NMT state. In addition, the "toggle bit" must be set correctly.

### 9.2.7.2 Heartbeat

If Heartbeat is activated, the slave sends its NMT state to the CAN bus unprompted and cyclically. You activate this service by setting the *Producer Heartbeat Time* in object `1017h:00h` to a value other than zero. The *Producer Heartbeat Time* is measured in milliseconds. The message sent by the slave has the form shown below:

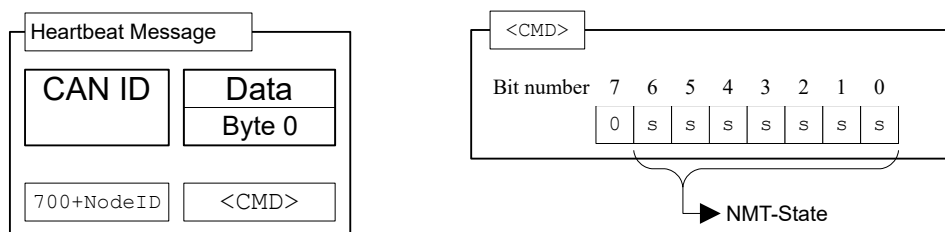

The slave must send the Heartbeat message within the *Heartbeat Consumer Time*. This time is known only to the master and is not stored in the controller.

The slave can also monitor a *Heartbeat* from another *producer* (master or another slave). To do this, enter the *Consumer Heartbeat Time* and the node-ID of the *producer* in object `1016h`.

Errors that occur during this monitoring are reset if either the function is deactivated or the *Heartbeat* is again sent within the correct time.

## 9.3 LSS protocol

The services of the *LSS protocol (Layer Settings Services)* are used to assign the node-ID and/or the baud rate of the controller directly via the CANopen bus. This is especially useful with devices that have no means for the mechanical configuration (e.g., rotary switches) of the parameters.

### 9.3.1 General

The *LSS protocol* requires a CANopen device in the network that performs the role of the *LSS master*. All other devices have the role of the *LSS slave*.

Each *LSS slave* is equipped with a unique *LSS address* that consists of the four 32-bit entries of object `1018h Identity Object`.

An *LSS slave* may either be in *configuration mode* or in *wait mode*. The *LSS master* is responsible for switching between the two modes. Some *LSS services (Configuration, Inquiry)* are only available in *configuration mode*.

### 9.3.2 LSS message

All messages of the *LSS protocol* consist of 8 bytes (*DLC=8*), whereby byte 0 always contains the *Command Specifier (CS)* of the service.

Two CAN IDs are reserved for the *LSS protocol*:

- `7E5h`: For the messages from the *LSS master* to the *LSS slaves* (request)



- 7E4<sub>h</sub>: For the messages from the *LSS slaves* to the *LSS master* (response)

### 9.3.3 LSS services

Four service categories are supported:

- Switch state services
- Configuration services
- Inquiry services
- Identification services

#### 9.3.3.1 Switch state services

With these services, the *LSS master* can switch the *LSS slaves* to *configuration mode* or to *wait mode*.

The node-ID and baud rate can only be changed with the Configuration services and Inquiry services while in *configuration mode*.

#### Switch state global service

With this service, the *LSS master* switches all *LSS slaves* in the network to *configuration mode* or to *wait mode*.

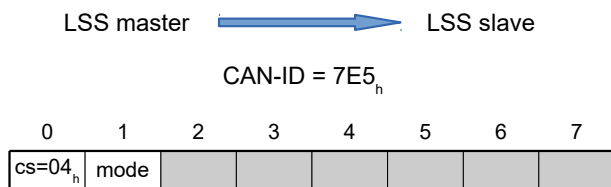

#### Byte 0 : CS (Command Specifier)

Value = "04<sub>h</sub>"

#### Byte 1: mode

Value = "00<sub>h</sub>": Switches to *wait mode*

Value = "01<sub>h</sub>": Switches to *configuration mode*

#### Bytes 2-7 :

reserved (=0<sub>h</sub>)

#### Switch state selective service

With this service, the *LSS master* switches the *LSS slaves* with the (or parts of the) corresponding *LSS address to configuration mode*.

The *LSS master* sends four messages, which contain the *LSS address*:

1. The *LSS master* switches the *LSS slaves* with the corresponding *vendor ID to configuration mode*:

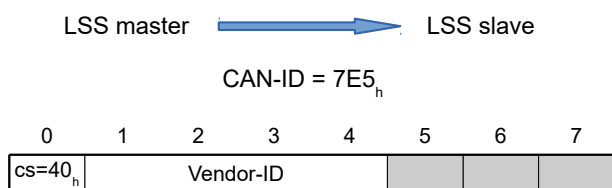

#### Byte 0 : CS (Command Specifier)

Value = "40<sub>h</sub>"

**Bytes 1-4: Vendor-ID**

Vendor-ID: see 1018<sub>h</sub>:01<sub>h</sub>

**Bytes 5-7:**

reserved (=0<sub>h</sub>)

2. The LSS master switches the LSS slaves with the corresponding product code to configuration mode:

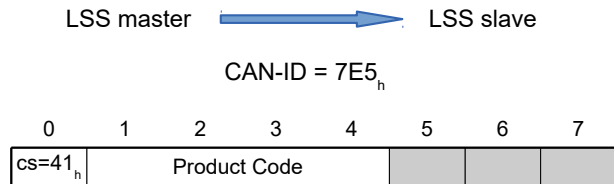

**Byte 0 : CS (Command Specifier)**

Value = "41<sub>h</sub>"

**Bytes 1-4: Product Code**

Product code: see 1018<sub>h</sub>:02<sub>h</sub>

**Bytes 5-7:**

reserved (=0<sub>h</sub>)

3. The LSS master switches the LSS slaves with the corresponding revision number to configuration mode:

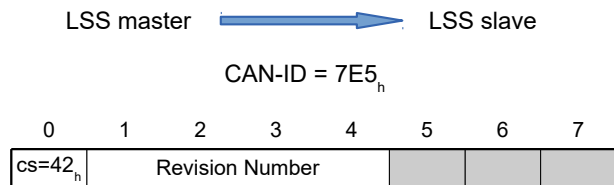

**Byte 0 : CS (Command Specifier)**

Value = "42<sub>h</sub>"

**Bytes 1-4: Revision Number**

Revision number: see 1018<sub>h</sub>:03<sub>h</sub>

**Bytes 5-7:**

reserved (=0<sub>h</sub>)

4. The LSS master switches the LSS slaves with the corresponding serial number to configuration mode:

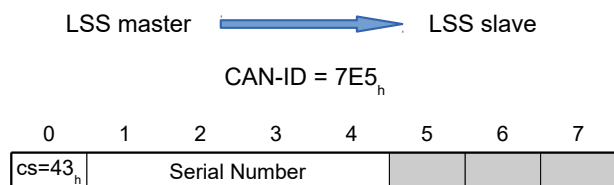

**Byte 0 : CS (Command Specifier)**

Value = "43<sub>h</sub>"

**Bytes 1-4: mode**

Serial number: see 1018<sub>h</sub>:04<sub>h</sub>

**Bytes 5-7:**reserved (=0<sub>h</sub>)

The *LSS slave* with the corresponding *LSS address* was switched to *configuration mode* and sends a confirmation:

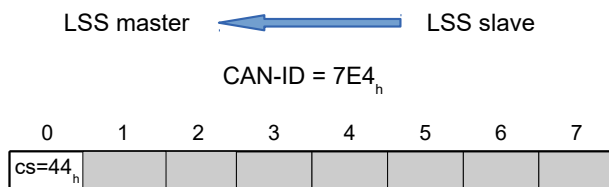
**Byte 0 : CS (Command Specifier)**Value = "44<sub>h</sub>"**Bytes 1-7 :**reserved (=0<sub>h</sub>)**9.3.3.2 Configuration services**

With these services, the *LSS master* can change and, if necessary, store the node-ID or baud rate of the *LSS slaves*.

**NOTICE**

The *LSS slaves* must be in *configuration mode*. See chapter [Switch state services](#).

**Configure node-ID service**

The *LSS master* sends a message with the new node-ID to an *LSS slave*:

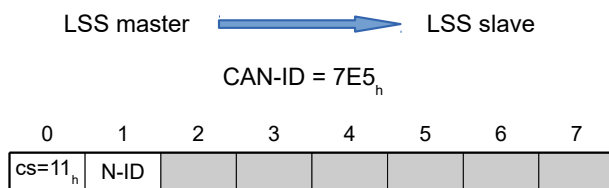
**Byte 0 : CS (Command Specifier)**Value = "11<sub>h</sub>"**Byte 1: N-ID (Node-ID)**Valid node-ID between 01<sub>h</sub> and 7F<sub>h</sub>**Bytes 2-7 :**reserved (=0<sub>h</sub>)

The *LSS slave* responds with a confirmation/error code:

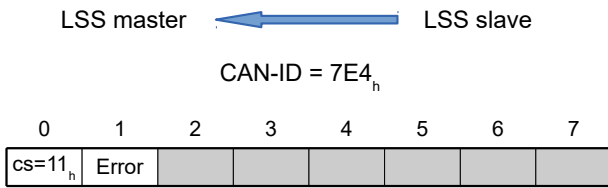

**Byte 0 : CS (Command Specifier)**

Value = "11<sub>h</sub>"

**Byte 1: Error Code**

Value = "00<sub>h</sub>": Not an error

Value = "01<sub>h</sub>": Invalid node-ID

**Bytes 2-7 :**

reserved (=0<sub>h</sub>)

**Configure bit timing parameters service**

The LSS master sends a message with the new baud rate to an LSS slave:

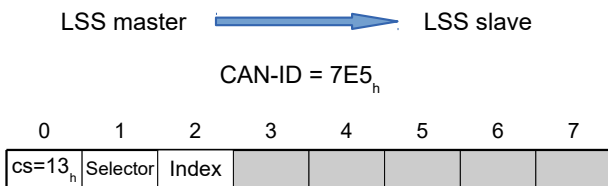

**Byte 0 : CS (Command Specifier)**

Value = "13<sub>h</sub>"

**Byte 1: Table Selector**

Value = "00<sub>h</sub>": The table for the baud rate from the CiA 301 standard is used.

**Byte 2: Table Index**

The value for the index is taken from the following table.

**Bytes 3-7 :**

reserved (=0<sub>h</sub>)

The following values are supported for the *Table Index*:

Table Index	Baud rate in kBd
0	1000
2	500
3	250
4	125
6	50
7	20
8	10

The *LSS slave* responds with a confirmation/error code:

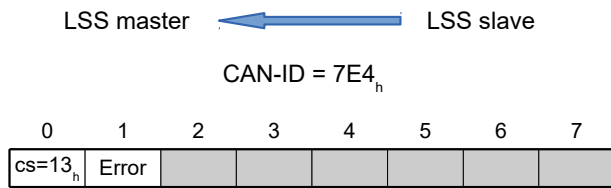

**Byte 0 : CS (Command Specifier)**

Value = "13<sub>h</sub>"

**Byte 1: Error Code**

Value = "00<sub>h</sub>": Not an error

Value = "01<sub>h</sub>": Invalid *Table Index*/baud rate is not supported

**Bytes 2-7 :**

reserved (=0<sub>h</sub>)

**Activate bit timing parameters service**

The *LSS master* uses this command to activate the set baud rate of all *LSS slaves* in the network simultaneously:

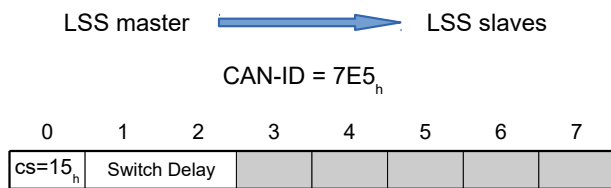

**Byte 0 : CS (Command Specifier)**

Value = "15<sub>h</sub>"

**Bytes 1-2: Switch Delay**

Delay in ms. It is thereby ensured that all *LSS slaves* in the network have the same baud rate before messages may again be sent.

After receiving this messages from each *LSS slave*, the time that is stored here is allowed to elapse. Only then is the new baud rate accepted.

The same time is allowed to elapse a second time; only then may an *LSS slave* send messages again.

**Bytes 3-7 :**

reserved (=0<sub>h</sub>)

**Store configuration service**

With this command, the *LSS master* saves the set node-ID and baud rate of an *LSS slave*. The *LSS master* must ensure that at that moment only one *LSS slave* in the network is in *configuration mode*.

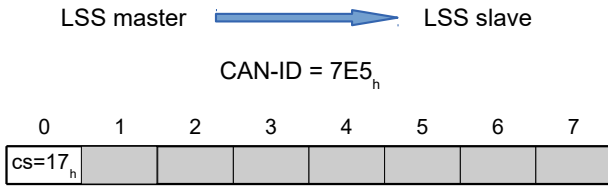

**Byte 0 : CS (Command Specifier)**

Value = "17<sub>h</sub>"

**Bytes 1-7 :**

reserved (=0<sub>h</sub>)

The LSS slave responds with a confirmation/error code:

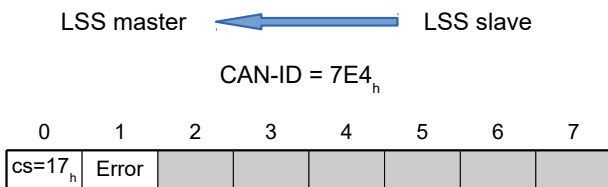

**Byte 0 : CS (Command Specifier)**

Value = "17<sub>h</sub>"

**Byte 1: Error Code**

Value = "00<sub>h</sub>": Not an error

Value = "02<sub>h</sub>": Access of non-volatile memory failed

**Bytes 2-7 :**

reserved (=0<sub>h</sub>)

**9.3.3.3 Inquiry services**

With these services, the LSS master can query the LSS address or the node-ID of an LSS slave. The LSS master must ensure that only one LSS slave in the network is in configuration mode.

**Inquire LSS address service**

With this service, the LSS master queries the LSS address of a slave.

1. The LSS master queries the vendor ID:

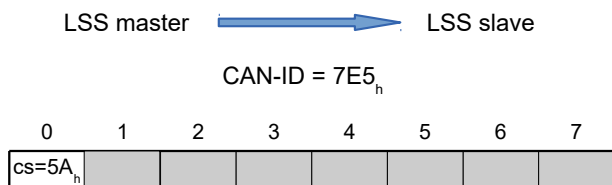

**Byte 0 : CS (Command Specifier)**

Value = "5A<sub>h</sub>"

**Bytes 1-7 :**

reserved (=0<sub>h</sub>)

The LSS slave returns its *vendor ID*:

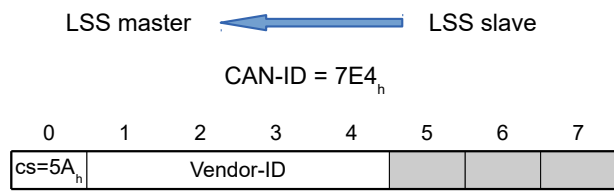

**Byte 0 : CS (Command Specifier)**

Value = "5A<sub>h</sub>"

**Bytes 1-4: Vendor-ID**

Vendor-ID: see 1018<sub>h</sub>:01<sub>h</sub>

**Bytes 5-7:**

reserved (=0<sub>h</sub>)

2. The LSS master queries the *product code*:

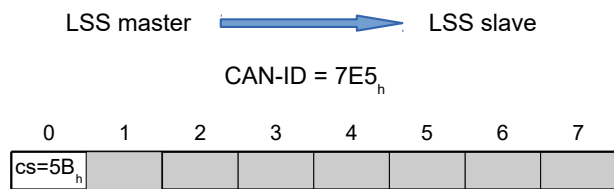

**Byte 0 : CS (Command Specifier)**

Value = "5B<sub>h</sub>"

**Bytes 1-7 :**

reserved (=0<sub>h</sub>)

The LSS slave returns its *product code*:

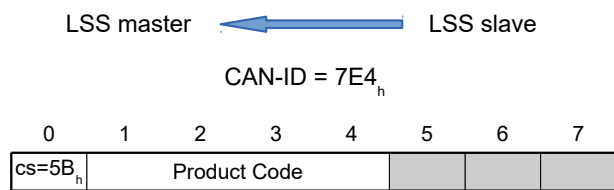

**Byte 0 : CS (Command Specifier)**

Value = "5B<sub>h</sub>"

**Bytes 1-4: Product Code**

Product code: see 1018<sub>h</sub>:02<sub>h</sub>

**Bytes 5-7:**

reserved (=0<sub>h</sub>)

3. The LSS master queries the *revision number*.

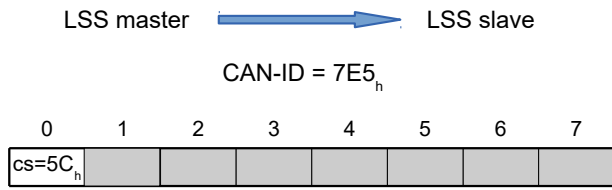

**Byte 0 : CS (Command Specifier)**

Value = "5C<sub>h</sub>"

The LSS slave returns its revision number.

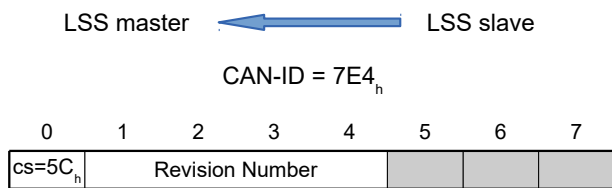

**Byte 0 : CS (Command Specifier)**

Value = "5C<sub>h</sub>"

**Bytes 1-4: Revision Number**

Revision number: see 1018<sub>h</sub>;03<sub>h</sub>

**Bytes 5-7:**

reserved (=0<sub>h</sub>)

4. The LSS master queries the serial number.

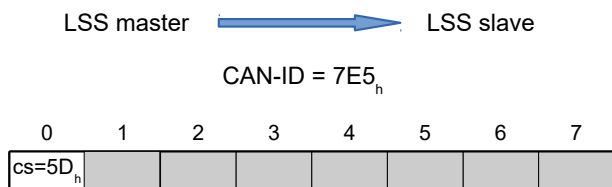

**Byte 0 : CS (Command Specifier)**

Value = "5D<sub>h</sub>"

**Bytes 1-7 :**

reserved (=0<sub>h</sub>)

The LSS slave returns its serial number.

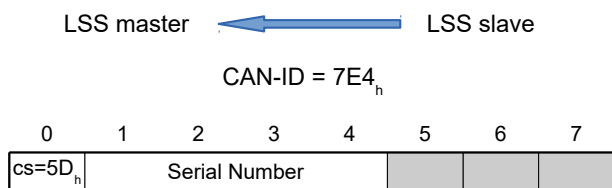

**Byte 0 : CS (Command Specifier)**

Value = "5D<sub>h</sub>"



**Bytes 1-4: Serial Number**

Serial number: see 1018<sub>h</sub>:04<sub>h</sub>

**Bytes 5-7:**

reserved (=0<sub>h</sub>)

**Inquire node-ID service**

With this service, the *LSS master* queries the node-ID of a slave.

The *LSS master* queries the node-ID:

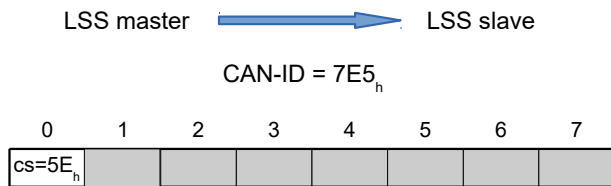

**Byte 0 : CS (Command Specifier)**

Value = "5E<sub>h</sub>"

**Bytes 1-7 :**

reserved (=0<sub>h</sub>)

The *LSS slave* responds with its node-ID:

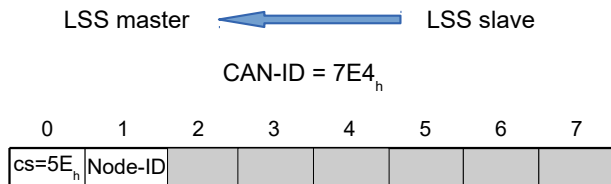

**Byte 0 : CS (Command Specifier)**

Value = "5E<sub>h</sub>"

**Byte 1: Node-ID**

Node-ID of the *LSS slave*

**Bytes 2-7 :**

reserved (=0<sub>h</sub>)

**9.3.3.4 Identification services**

With these services, the *LSS master* can ask the *LSS slaves* to identify themselves based on their *LSS address*.

**LSS identify remote slave service**

With this service, the *LSS master* asks the *LSS slaves* to identify themselves with the (or parts of the) corresponding *LSS address* with the LSS identify slave service.

A range can be defined for the *revision number* and the *serial number*. All *LSS slaves* whose numbers are in the corresponding range must identify themselves. It is the task of the *LSS master* to restrict the range so that ultimately only one *LSS slave* responds.

1. The *LSS master* defines the *Vendor-ID* of the *LSS slaves* that are to identify themselves:

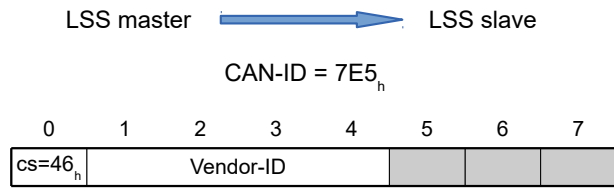
**Byte 0 : CS (Command Specifier)**Value = "46<sub>h</sub>"**Bytes 1-4: Vendor-ID**Vendor-ID: see 1018<sub>h</sub>:01<sub>h</sub>**Bytes 5-7:**reserved (=0<sub>h</sub>)

2. The LSS master defines the *product code* of the LSS slaves that are to identify themselves.:

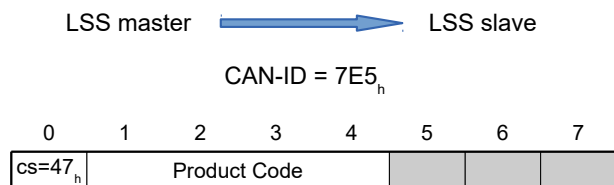
**Byte 0 : CS (Command Specifier)**Value = "47<sub>h</sub>"**Bytes 1-4: Product Code**Product code: see 1018<sub>h</sub>:02<sub>h</sub>**Bytes 5-7:**reserved (=0<sub>h</sub>)

3. The LSS master defines the lowest and highest *revision number* of a range. All LSS slaves whose *revision number* is within this range are to identify themselves:

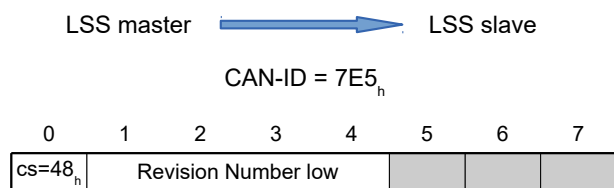
**Byte 0 : CS (Command Specifier)**Value = "48<sub>h</sub>"**Bytes 1-4: Revision Number low**Lowest *revision number* of the range: see 1018<sub>h</sub>:03<sub>h</sub>**Bytes 5-7:**reserved (=0<sub>h</sub>)

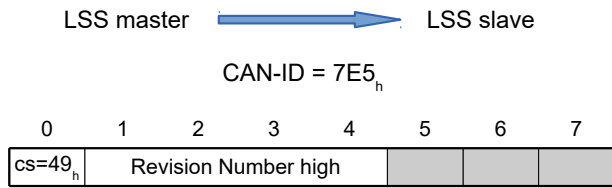

**Byte 0 : CS (Command Specifier)**

Value = "49<sub>h</sub>"

**Bytes 1-4: Revision Number high**

Highest *revision number* of the range: see 1018<sub>h</sub>:03<sub>h</sub>

**Bytes 5-7:**

reserved (=0<sub>h</sub>)

4. The LSS master defines the lowest and highest *serial number* of a range. All LSS slaves whose *serial number* is within this range are to identify themselves:

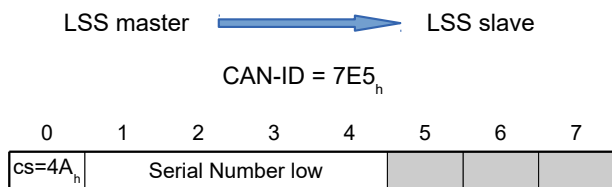

**Byte 0 : CS (Command Specifier)**

Value = "4A<sub>h</sub>"

**Bytes 1-4: Serial Number low**

Lowest *serial number* of the range: see 1018<sub>h</sub>:04<sub>h</sub>

**Bytes 5-7:**

reserved (=0<sub>h</sub>)

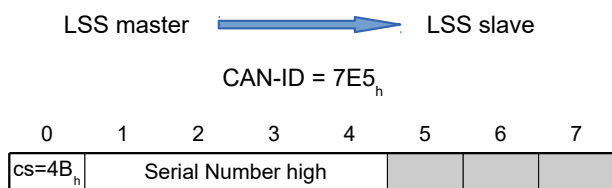

**Byte 0 : CS (Command Specifier)**

Value = "4B<sub>h</sub>"

**Bytes 1-4: Serial Number high**

Highest *serial number* of the range: see 1018<sub>h</sub>:04<sub>h</sub>

**Bytes 5-7:**

reserved (=0<sub>h</sub>)

**LSS identify slave service**

The LSS slave whose LSS address was defined with the LSS identify remote slave service by the LSS master identifies itself:

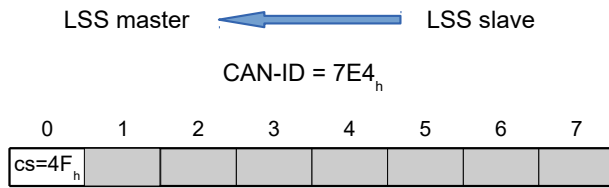
**Byte 0 : CS (Command Specifier)**Value = "4F<sub>h</sub>"**Bytes 1-7 :**reserved (=0<sub>h</sub>)**9.3.4 Example**

The controller (*LSS slave*) is delivered with the following parameters:

- Node-ID = 7F<sub>h</sub> (=127<sub>d</sub>)
- Baud rate = 1000 kBd

The parameters are to be set as follows:

- Node-ID = 05<sub>h</sub> (=5<sub>d</sub>)
- Baud rate = 125 kBd

It is assumed that only one *LSS slave* is currently present in the network.

1. The *LSS master* switches the *LSS slave* to *configuration mode* (see [Switch state global service](#)):  
7E5 | 04 01 00 00 00 00 00 00
2. The *LSS master* queries the node-ID of the *LSS slave* (see [Inquire node-ID service](#)):  
7E5 | 5E 00 00 00 00 00 00 00  
The *LSS slave* responds with its node-ID:  
7E4 | 5E 7F 00 00 00 00 00 00
3. The *LSS master* sets the node-ID to "05<sub>h</sub>" (see [Configure node-ID service](#)):  
7E5 | 11 05 00 00 00 00 00 00  
The *LSS slave* confirms (error code=00<sub>h</sub>):  
7E4 | 11 00 00 00 00 00 00 00
4. The *LSS master* sets the baud rate to 125 kBd (*Table Index=4*) (see [Configure bit timing parameters service](#)):  
7E5 | 13 00 04 00 00 00 00 00  
The *LSS slave* confirms (error code=00<sub>h</sub>):  
7E4 | 13 00 00 00 00 00 00 00
5. The *LSS master* sends the command to save the changes (see [Store configuration service](#)):  
7E5 | 17 00 00 00 00 00 00 00
6. The *LSS master* switches the *LSS slave* to *wait mode* (see [Switch state global service](#)):  
7E5 | 04 00 00 00 00 00 00 00  
The *LSS slave* confirms (error code=00<sub>h</sub>):  
7E4 | 17 00 00 00 00 00 00 00
7. The new parameters are accepted after the controller is restarted.

The controller registers with node-ID 5 and baud rate 125 kBd:

705 | 00

## 10 Programming with *NanoJ*

*NanoJ* is a programming language similar to C or C++. *NanoJ* is integrated in the *Plug & Drive Studio* software. You can find further information in document *Plug & Drive Studio: Quick Start Guide* at [us.nanotec.com](http://us.nanotec.com).

### 10.1 *NanoJ* program

A *NanoJ* program makes a protected runtime environment available within the firmware. Here, the user can create his own processes. These can then trigger functions in the controller by, for example, reading or writing entries in the object dictionary.

Through the use of protective mechanisms, a *NanoJ* program is prevented from crashing the firmware. In the worst case, the execution is interrupted with an error code stored in the object dictionary.

If the *NanoJ* program was loaded on the controller, it is automatically executed after the controller is switched on or restarted, as long as you do not set bit 0 in object `2300h` to "0".

#### 10.1.1 Available computing time

A *NanoJ* program receives computing time cyclically in a 1 ms clock (see following figure). Because computing time is lost through interrupts and system functions of the firmware, only approx. 30% – 50% of computing time is available to the user program (depending on control mode and application). In this time, the user program must run through the cycle and either complete the cycle or yield the computing time by calling the `yield()` function. In the former case, the user program is restarted with the start of the next 1 ms cycle; the latter results in the program being continued on the next 1 ms cycle with the command that follows the `yield()` function.

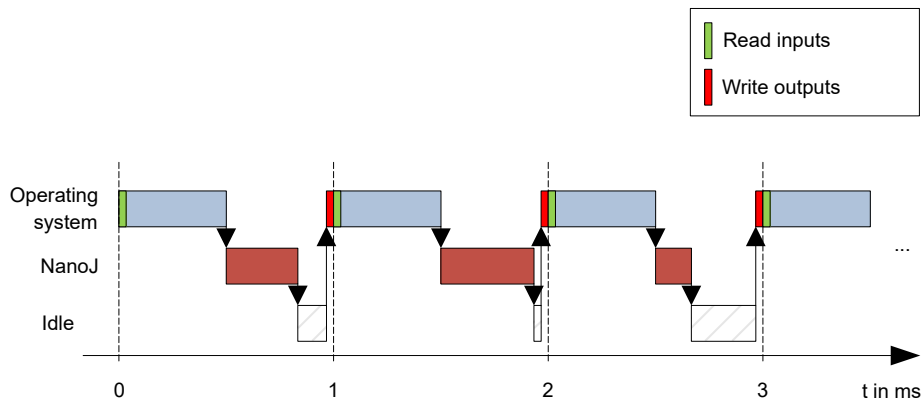

If the *NanoJ* program needs more time than was allotted, it is ended and an error code set in the object dictionary.

#### TIP



When developing user programs, the runtime behavior must be carefully examined, especially for more time-intensive tasks. For example, it is therefore recommended that tables be used instead of calculating a sine value using a `sin` function.

### NOTICE



If the *NanoJ program* does not yield the computing time after too long a time, it is ended by the operating system. In this case, the number 4 is entered in the statusword for object 2301<sub>h</sub>; in the error register for object 2302<sub>h</sub>, the number 5 (timeout) is noted, see [2301h NanoJ Status](#) and [2302h NanoJ Error Code](#).

To keep the *NanoJ program* from stopping, you can activate *AutoYield* mode by writing value "5" in 2300<sub>h</sub>. In *AutoYield* mode, however, the *NanoJ program* is no longer real-time capable and no longer runs every 1 ms.

### 10.1.2 Protected runtime environment

Using process-specific properties, a so-called *protected runtime environment* is generated. A user program in the protected runtime environment is only able to access specially allocated memory areas and system resources. For example, an attempt to directly write to a processor IO register is acknowledged with an *MPU Fault* and the user program terminated with the corresponding error code in the object dictionary.

### 10.1.3 NanoJ program – communication possibilities

A *NanoJ program* has a number of possibilities for communicating with the controller:

- Read and write OD values using PDO mapping
- Directly read and write OD values via NanoJ functions
- Call other NanoJ functions (e.g., write [debug output](#))

The OD values of the user program are made available in the form of variables via *PDO mapping*. Before a user program receives the 1 ms time slot, the firmware transfers the values from the object dictionary to the variables of the user program. As soon as the user program receives computing time, it can manipulate these variables as regular C variables. At the end of the time slot, the new values are then automatically copied by the firmware back to the respective OD entries.

To optimize the performance, three types of mapping are defined: input, output, and input/output (In, Out, InOut).

- *Input mappings* can only be read; they are not transferred back to the object dictionary.
- *Output mappings* can only be written.
- *Input/output mappings*, on the other hand, can both be read and written.

The set mappings can be read and checked via the GUI for objects 2310<sub>h</sub>, 2320<sub>h</sub>, and 2330<sub>h</sub>. Up to 16 entries are allowed for each mapping.

Whether a variable is stored in the input, output or data range is controlled in *Plug & Drive Studio* via the specification of the *linker section*.

### NanoJ inputs and NanoJ outputs

To communicate with the *NanoJ program* via the respective interface, you can use the following objects:

- [2400h NanoJ Inputs](#): Array with thirty-two S32 values for passing values to the *NanoJ program*
- [2410h NanoJ Init Parameters](#): Array with thirty-two S32 values. This object can be stored, unlike 2400<sub>h</sub>.
- [2500h NanoJ Outputs](#): Array with thirty-two S32 values, where the *NanoJ program* can store values that can be read out via the fieldbus

### 10.1.4 Executing a NanoJ program

When executing a cycle, the *NanoJ program* essentially consists of the following three steps with respect to the PDO mapping:

1. Read values from the object dictionary and copy them to the input and output areas
2. Execute a user program
3. Copy values from the output and input areas back to the object dictionary

The configuration of the copy processes is based on the CANopen standard.

In addition, values of the object dictionary can be accessed via NanoJ functions. This is generally slower; mappings are therefore to be preferred. The number of mappings is limited (16 entries each in In/Out/InOut).

#### TIP



Nanotec recommends: Map OD entries that are used and changed frequently and use NanoJ function to access OD entries that are used less frequently.

A list of available NanoJ functions can be found in chapter [NanoJ functions in the NanoJ program](#).

#### TIP



Nanotec recommends accessing a given OD value either by mapping or using a NanoJ function with `od_write()`. If both are used simultaneously, the NanoJ function has no effect.

### 10.1.5 NanoJ program – OD entries

The *NanoJ program* is controlled and configured in object range 2300<sub>h</sub> to 2330<sub>h</sub> (see [2300h NanoJ Control](#)).

OD-Index	Name and description
2300 <sub>h</sub>	<a href="#">2300h NanoJ Control</a>
2301 <sub>h</sub>	<a href="#">2301h NanoJ Status</a>
2302 <sub>h</sub>	<a href="#">2302h NanoJ Error Code</a>
2310 <sub>h</sub>	<a href="#">2310h NanoJ Input Data Selection</a>
2320 <sub>h</sub>	<a href="#">2320h NanoJ Output Data Selection</a>
2330 <sub>h</sub>	<a href="#">2330h NanoJ In/output Data Selection</a>

#### Example:

To start the *TEST1.USR* user program, the following sequence can, for example, be used:

- Check entry 2302<sub>h</sub> for error code.
- If no error:  
Start the *NanoJ program* by writing object 2300<sub>h</sub>, bit 0 = "1" or by restarting the controller.

#### NOTICE



It can take up to 200 ms for the NanoJ program to start.

- Check entry 2302<sub>h</sub> for error code and object 2301<sub>h</sub>, bit 0 = "1".

To stop a running program: write entry 2300<sub>h</sub> with bit 0 value = "0".

### 10.1.6 Structure of a NanoJ program

A user program consists of at least two instructions:

- the preprocessor instruction `#include "wrapper.h"`
- the `void user() {}` function

The code to be executed can be stored in the `void user()` function.

### NOTICE



The file names of the user programs must not be longer than eight characters plus three characters in the suffix; file name `main.cpp` is permissible, file name `aLongFileName.cpp` is not permissible.

### NOTICE



In *NanoJ programs*, global variables may only be initialized within functions. It then follows:

- No `new` operator
- No constructors
- No initialization of global variables outside of functions

### Examples:

The global variable is to be initialized within the `void user()` function:

```
unsigned int i;
void user(){
  i = 1;
  i += 1;
}
```

The following assignment results in an error during compilation:

```
unsigned int i = 1;
void user() {
  i += 1;
}
```

### 10.1.7 NanoJ program example

The example shows the programming of a square wave signal in object `2500h:01h`.

```
// file main.cpp
map S32 outputReg1 as inout 0x2500:1
#include "wrapper.h"

// user program
void user()
{
  U16 counter = 0;
  while( 1 )
  {
    ++counter;

    if( counter < 100 )
      InOut.outputReg1 = 0;
    else if( counter < 200 )
      InOut.outputReg1 = 1;
    else
      counter = 0;

    // yield() 5 times (delay 5ms)
    for(U08 i = 0; i < 5; ++i )
      yield();
  }
} // eof
```

You can find other examples at [us.nanotec.com](http://us.nanotec.com).



## 10.2 Mapping in the NanoJ program

With this method, a variable in the *NanoJ program* is linked directly with an entry in the object dictionary. The creation of the mapping must be located at the start of the file here, even before the `#include "wrapper.h"` instruction.

### TIP

Nanotec recommends:



- Use mapping if you need to access an object in the object dictionary frequently, e. g., *controlword* 6040<sub>h</sub> or *statusword* 6041<sub>h</sub>.
- The `od_write()` and `od_read()` functions are better suited for accessing objects a single time, see [Accessing the object dictionary](#).

### 10.2.1 Declaration of the mapping

The declaration of the mapping is structured as follows:

```
map <TYPE> <NAME> as <input|output|inout> <INDEX>:<SUBINDEX>
```

Where:

- `<TYPE>`  
The data type of the variable; U32, U16, U08, S32, S16 or S08.
- `<NAME>`  
The name of the variable as it is used in the user program.
- `<input|output|inout>`  
The read and write permission of a variable: a variable can be declared as an *input*, *output* or *inout*. This defines whether a variable is readable (*input*), writable (*output*) or both (*inout*) and the structure by means of which it must be addressed in the program.
- `<INDEX>:<SUBINDEX>`  
Index and subindex of the object to be mapped in the object dictionary.

Each declared variable is addressed in the user program via one of the three structures: *In*, *Out* or *InOut* depending on the defined write and read direction.

### NOTICE



A comment is only permitted above the respective mapping declaration in the code, not on the same line.

### 10.2.2 Example of mapping

Example of a mapping and the corresponding variable accesses:

```
// 6040h:00h is UNSIGNED16
map U16 controlWord as output 0x6040:00
// 6041h:00h is UNSIGNED16
map U16 statusWord as input 0x6041:00

// 6060h:00h is SIGNED08 (INTEGER8)
map S08 modeOfOperation as inout 0x6060:00
```

```
#include "wrapper.h"

void user()
{
  [...]
  Out.controlWord = 1;
  U16 tmpVar = In.statusword;
  InOut.modeOfOperation = tmpVar;
  [...]
}
```

### 10.2.3 Possible error at od\_write()

A possible source of errors is a write access with the `od_write()` function (see [NanoJ functions in the NanoJ program](#)) of an object in the object dictionary that was simultaneously created as mapping. The code listed in the following is incorrect:

```
map U16 controlWord as output 0x6040:00
#include " wrapper.h"
void user()
{
  [...]
  Out.controlWord = 1;
  [...]
  od_write(0x6040, 0x00, 5 ); // der Wert wird durch das Mapping überschrieben
  [...]
}
```

The line with the `od_write(0x6040, 0x00, 5 );` command has no effect. As described in the introduction, all mappings are copied to the object dictionary at the end of each millisecond.

This results in the following sequence:

1. The `od_write` function writes the value 5 in object 6040<sub>h</sub>:00<sub>h</sub>.
2. At the end of the 1 ms cycle, the mapping is written that also specifies object 6040<sub>h</sub>:00<sub>h</sub>, however, with the value 1.
3. From the perspective of the user, the `od_write` command thus serves no purpose.

## 10.3 NanoJ functions in the NanoJ program

With NanoJ functions, it is possible to call up functions integrated in the firmware directly from a user program. Code can only be directly executed in the protected area of the protected execution environment and is realized via so-called *Cortex Supervisor Calls* (Svc Calls). Here, an interrupt is triggered when the function is called, thereby giving the firmware the possibility to temporarily permit code execution outside of the protected execution environment. Developers of user programs do not need to worry about this mechanism – for them, the NanoJ functions can be called up like normal C functions. Only the *wrapper.h* file needs to be integrated as usual.

### 10.3.1 Accessing the object dictionary

`void od_write (U32 index, U32 subindex, U32 value)`

This function writes the transferred value to the specified location in the object dictionary.

index	Index of the object to be written in the object dictionary
subindex	Subindex of the object to be written in the object dictionary
value	Value to be written

<b>NOTICE</b>
---------------



It is highly recommended that the processor time be passed on with `yield()` after calling a `od_write()`. The value is immediately written to the OD. For the firmware to be able to trigger actions that are dependent on this, however, it must receive computing time. This, in turn, means that the user program must either be ended or interrupted with `yield()`.

U32 **od\_read** (U32 index, U32 subindex)

This function reads the value at the specified location in the object dictionary and returns it.

index	Index of the object to be read in the object dictionary
subindex	Subindex of the object to be read in the object dictionary
Output value	Content of the OD entry

<b>NOTICE</b>
---------------



Active waiting for a value in the object dictionary should always be associated with a `yield()`.

### Example

```
while (od_read(2400,2) != 0) // wait until 2400:2 is set
{ yield(); }
```

### 10.3.2 Process control

```
void yield()
```

This function returns the processor time to the operating system. In the next time slot, the program continues at the location after the call.

```
void sleep (U32 ms)
```

This function returns the processor time to the operating system for the specified number of milliseconds. The user program is then continued at the location after the call.

ms	Time to be waited in milliseconds
----	-----------------------------------

### 10.3.3 Debug output

The following functions output a value in the debug console. They differ with respect to the data type of the parameter to be passed.

```
bool VmmDebugOutputString (const char *outstring)
```

```
bool VmmDebugOutputInt (const U32 val)
```

```
bool VmmDebugOutputByte (const U08 val)
```

```
bool VmmDebugOutputHalfWord (const U16 val)
```

```
bool VmmDebugOutputWord (const U32 val)
```

```
bool VmmDebugOutputFloat (const float val)
```

#### NOTICE



The debug outputs are first written to a separate area of the object dictionary and read from there by the *Plug & Drive Studio*.

This OD entry has index 2600<sub>h</sub> and is 64 characters long, see [2600h NanoJ Debug Output](#). Subindex 00 always contains the number of characters already written.

If the buffer is full, `VmmDebugOutputxxx()` initially fails; execution of the user program ceases and it stops at the location of the debug output. Only after the GUI has read the buffer and after subindex 00 has been reset does the program continue and `VmmDebugOutputxxx()` returns to the user program.

#### NOTICE



Debug outputs may therefore only be used during the test phase when developing a user program.

#### NOTICE



Do not use the debug output if *AutoYield* mode is activated (see [Available computing time](#)).

## 10.4 Restrictions and possible problems

Restrictions and possible problems when working with NanoJ are listed below:

Restriction/problem	Measure
If an object is mapped, e. g., 0x6040, the object is reset to its previous value every 1 ms. This makes it impossible to control this object via the fieldbus or the <i>Plug &amp; Drive Studio</i> .	Instead use <code>od_read/od_write</code> to access the object.
If an object was mapped as output and the value of the object was never defined before starting the <i>NanoJ program</i> , the value of this object may be random.	Initialize the values of the mapped objects in your NanoJ program to ensure that it behaves deterministically.

Restriction/problem	Measure
The array initialization must not be used with more than 16 entries.	Use <code>constant array</code> instead.
Too many local variables and arrays within functions may result in a stack overflow.	Declare the variables globally. Memory requirements are monitored already during compilation; errors do not occur at runtime.
Functions that are too deeply nested may result in a stack overflow.	Observe a maximum nesting depth of 2.
<code>float</code> must not be used with comparison operators.	Use <code>int</code> instead.
<code>double</code> must not be used.	
If a NanoJ program restarts the controller (either directly with an explicit restart or indirectly, e. g., through the use of the Reset function), the controller may fall into a restart loop that can be exited only with difficulty if at all.	
<code>math</code> or <code>cmath</code> cannot be included.	

## 11 Description of the object dictionary

### 11.1 Overview

This chapter contains a description of all objects.

You will find information here on:

- Functions
- Object descriptions ("Index")
- Value descriptions ("Subindices")
- Descriptions of bits
- Description of the object

### 11.2 Structure of the object description

The description of the object entries always has the same structure and usually consists of the following sections:

#### Function

The function of the object dictionary is briefly described in this section.

#### Object description

This table provides detailed information on the data type, preset values and similar. An exact description can be found in section "[Object description](#)"

#### Value description

This table is only available with the "Array" or "Record" data type and provides exact information about the sub-entries. A more exact description of the entries can be found in section "[Value description](#)"

#### Description

Here, more exact information on the individual bits of an entry is provided or any compositions explained. A more exact description can be found in section "[Description](#)"

### 11.3 Object description

The object description consists of a table that contains the following entries:

#### Index

Designates the object index in hexadecimal notation.

#### Object name

The name of the object.

#### Object Code

The type of object. This can be one of the following entries:

- VARIABLE: In this case, the object consists of only a variable that is indexed with subindex 0.
- ARRAY: These objects always consists of a subindex 0 – which specifies the number of sub-entries – and the sub-entries themselves, beginning with index 1. The data type within an array never changes, i.e., sub-entry 1 and all subsequent entries are always of the same data type.
- RECORD: These objects always consists of a subindex 0 – which specifies the number of sub-entries – and the sub-entries themselves, beginning with index 1. Unlike an ARRAY, the data type of the sub-entries can vary. This means that, e.g., sub-entry 1 may be of a different data type than sub-entry 2.

- **VISIBLE\_STRING**: The object describes a character string coded in ASCII. The length of the string is specified in subindex 0; the individual characters are stored beginning in subindex 1. These character strings are **not** terminated by a null character.

### Data type

The size and interpretation of the object is specified here. The following notation is used for the "VARIABLE" object code:

- A distinction is made between entries that are signed; these are designated with the prefix "SIGNED". For entries that are unsigned, the prefix "UNSIGNED" is used.
- The size of the variable in bits is placed before the prefix and can be 8, 16 or 32.

### Savable

Described here is whether this object is savable and, if so, in which category.

### Firmware version

The firmware version beginning with which the object is available is entered here.

### Change history (ChangeLog)

Any changes to the object are noted here.

There are also the following table entries for the "VARIABLE" data type:

### Access

The access restriction is entered here. The following restrictions are available:

- "read/write": The object can both be read as well as written
- "read only": The object can only be read from the object dictionary. It is not possible to set a value.

### PDO mapping

Some bus systems, such as CANopen or EtherCAT, support PDO mapping. Described in this table entry is whether the object can be inserted into a mapping and, if so, into which. The following designations are available here:

- "no": The object may not be entered in a mapping.
- "TX-PDO": The object may be entered in an RX mapping.
- "RX-PDO": The object may be entered in a TX mapping.

### Allowed values

In some cases, only certain values may be written in the object. If this is the case, these values are listed here. If there are no restrictions, the field is empty.

### Preset value

To bring the controller to a secured state when switching on, it is necessary to preset a number of objects with values. The value that is written in the object when the controller is started is noted in this table entry.

## 11.4 Value description

### NOTICE



For the sake of clarity, a number of subindices are grouped together if the entries all have the same name.

Listed in the table with the "Value description" heading are all data for sub-entries with subindex 1 or higher. The table contains the following entries:

**Subindex**

Number of the currently written sub-entry.

**Name**

Name of the sub-entry.

**Data type**

The size and interpretation of the sub-entry is specified here. The following notation always applies here:

- A distinction is made between entries that are signed; these are designated with the prefix "SIGNED". For entries that are unsigned, the prefix "UNSIGNED" is used.
- The size of the variable in bits is placed before the prefix and can be 8, 16 or 32.

**Access**

The access restriction for the sub-entry is entered here. The following restrictions are available:

- "read/write": The object can both be read as well as written
- "read only": The object can only be read from the object dictionary. It is not possible to set a value.

**PDO mapping**

Some bus systems, such as CANopen or EtherCAT, support PDO mapping. Described in this table entry is whether the sub-entry can be inserted into a mapping and, if so, into which. The following designations are available here:

- "no": The object may not be entered in a mapping.
- "TX-PDO": The object may be entered in an RX mapping.
- "RX-PDO": The object may be entered in a TX mapping.

**Allowed values**

In some cases, only certain values may be written in the sub-entry. If this is the case, these values are listed here. If there are no restrictions, the field is empty.

**Preset value**

To bring the controller to a secured state when switching on, it is necessary to preset a number of sub-entries with values. The value that is written in the sub-entry when the controller is started is noted in this table entry.

### 11.5 Description

This section may be present if use requires additional information. If individual bits of an object or sub-entry have different meaning, diagrams as shown in the following example are used.

**Example:** The object is 8 bits in size; bit 0 and bit 1 have different functions. Bits 2 and 3 are grouped into one function; the same applies for bits 4 to 7.

7	6	5	4	3	2	1	0
Example [4]				Example [2]		B	A

**Example [4]**

Description of bit 4 up to and including bit 7; these bits are logically related. The 4 in square brackets specifies the number of related bits. A list with possible values and their description is often attached at this point.



**Example [2]**

Description of bits 3 and 2; these bits are logically related. The 2 in square brackets specifies the number of related bits.

- Value 00<sub>b</sub>: The description here applies if bit 2 and bit 3 are "0".
- Value 01<sub>b</sub>: The description here applies if bit 2 is "0" and bit 3 is "1".
- Value 10<sub>b</sub>: The description here applies if bit 2 is "1" and bit 3 is "0".
- Value 11<sub>b</sub>: The description here applies if bit 2 and bit 3 are "1".

**B**

Description of bit B; no length is specified for a single bit.

**A**

Description of bit A; bits with a gray background are not used.

**1000h Device Type****Function**

Describes the controller type.

**Object description**

Index	1000 <sub>h</sub>
Object name	Device Type
Object Code	VARIABLE
Data type	UNSIGNED32
Savable	no
Access	read only
PDO mapping	no
Allowed values	
Preset value	00060192 <sub>h</sub>
Firmware version	FIR-v1426
Change history	

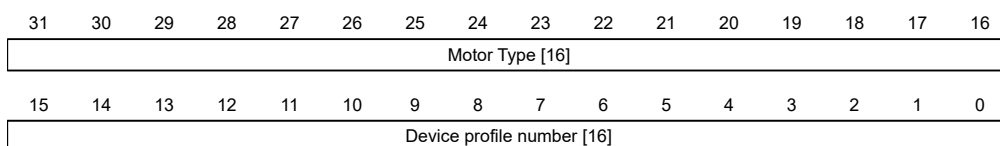
**Description****Motor Type[16]**

Describes the supported motor type. The following values are possible:

- Bit 23 to bit 16: Value "2": BLDC motor
- Bit 23 to bit 16: Value "4": Stepper motor
- Bit 23 to bit 16: Value "6": Stepper motor as well as BLDC motor

**Device profile number[16]**

Describes the supported CANopen standard.

Values:

0192<sub>h</sub> or 0402<sub>d</sub> (preset value): The CiA 402 standard is supported.

## 1001h Error Register

### Function

Error register: The corresponding error bit is set in case of an error. If the error no longer exists, it is deleted automatically.



#### NOTICE

For each error that occurs, a more precise error code is stored in object 1003<sub>h</sub>.

### Object description

Index	1001 <sub>h</sub>
Object name	Error Register
Object Code	VARIABLE
Data type	UNSIGNED8
Savable	no
Access	read only
PDO mapping	TX-PDO
Allowed values	
Preset value	00 <sub>h</sub>
Firmware version	FIR-v1426
Change history	

### Description

7	6	5	4	3	2	1	0
MAN	RES	PROF	COM	TEMP	VOL	CUR	GEN

#### GEN

General error

#### CUR

Current

#### VOL

Voltage

#### TEMP

Temperature

#### COM

Communication

#### PROF

Relates to the device profile

**RES**

Reserved, always "0"

**MAN**

Manufacturer-specific

**1003h Pre-defined Error Field****Function**

This object contains an error stack with up to eight entries.

**Object description**

Index	1003 <sub>h</sub>
Object name	Pre-defined Error Field
Object Code	ARRAY
Data type	UNSIGNED32
Savable	no
Firmware version	FIR-v1426
Change history	

**Value description**

Subindex	00 <sub>h</sub>
Name	Number Of Errors
Data type	UNSIGNED8
Access	read / write
PDO mapping	no
Allowed values	
Preset value	00 <sub>h</sub>

Subindex	01 <sub>h</sub>
Name	1st Standard Error Field
Data type	UNSIGNED32
Access	read only
PDO mapping	no
Allowed values	
Preset value	00000000 <sub>h</sub>

Subindex	02 <sub>h</sub>
Name	2nd Standard Error Field
Data type	UNSIGNED32
Access	read only
PDO mapping	no
Allowed values	

Preset value	00000000 <sub>h</sub>
Subindex	03 <sub>h</sub>
Name	3th Standard Error Field
Data type	UNSIGNED32
Access	read only
PDO mapping	no
Allowed values	
Preset value	00000000 <sub>h</sub>
Subindex	04 <sub>h</sub>
Name	4th Standard Error Field
Data type	UNSIGNED32
Access	read only
PDO mapping	no
Allowed values	
Preset value	00000000 <sub>h</sub>
Subindex	05 <sub>h</sub>
Name	5th Standard Error Field
Data type	UNSIGNED32
Access	read only
PDO mapping	no
Allowed values	
Preset value	00000000 <sub>h</sub>
Subindex	06 <sub>h</sub>
Name	6th Standard Error Field
Data type	UNSIGNED32
Access	read only
PDO mapping	no
Allowed values	
Preset value	00000000 <sub>h</sub>
Subindex	07 <sub>h</sub>
Name	7th Standard Error Field
Data type	UNSIGNED32
Access	read only
PDO mapping	no
Allowed values	
Preset value	00000000 <sub>h</sub>
Subindex	08 <sub>h</sub>

Name	8th Standard Error Field
Data type	UNSIGNED32
Access	read only
PDO mapping	no
Allowed values	
Preset value	00000000 <sub>h</sub>

## Description

### General function

If a new error occurs, it is entered in subindex 1. The already existing entries in subindices 1 to 7 are moved back one position. The error in subindex 7 is thereby removed.

The number of errors that have already occurred can be read from the object with subindex 0. If no error is currently entered in the error stack, it is not possible to read one of the eight subindices 1–8 and an error (abort code = 08000024<sub>h</sub>) is sent in response. If a "0" is written in subindex 0, counting starts again from the beginning.

### Bit description

31	30	29	28	27	26	25	24	23	22	21	20	19	18	17	16
Error Number [8]								Error Class [8]							
15	14	13	12	11	10	9	8	7	6	5	4	3	2	1	0
Error Code [16]															

### Error Number [8]

This can be used to pinpoint the cause of the error. The meaning of the number can be found in the following table.

Error number	Description
0	Watchdog-Reset
1	Input voltage (+Ub) too high
2	Output current too high
3	Input voltage (+Ub) too low
4	Error at fieldbus
6	CANopen only: NMT master takes too long to send Nodeguarding request
7	Sensor 1 (see 3204 <sub>h</sub> ): Error through electrical fault or defective hardware
8	Sensor 2 (see 3204 <sub>h</sub> ): Error through electrical fault or defective hardware
9	Sensor 3 (see 3204 <sub>h</sub> ): Error through electrical fault or defective hardware
10	Warning: Positive limit switch exceeded
11	Warning: Negative limit switch exceeded
12	Overtemperature error
13	The values of object 6065 <sub>h</sub> (Following Error Window) and object 6066 <sub>h</sub> (Following Error Time Out) were exceeded; a fault was triggered.
14	Warning: Nonvolatile memory full. The current save process could not be completed; parts of the data of the save process are lost. Controller must be restarted for cleanup work.
15	Motor blocked
16	Warning: Nonvolatile memory damaged; controller must be restarted for cleanup work (all saved objects are reset to default).
17	CANopen only: Slave took too long to send PDO messages.

Error number	Description
18	Sensor n (see <a href="#">3204<sub>h</sub></a> ), where n is greater than 3: Error through electrical fault or defective hardware
19	CANopen only: PDO not processed due to a length error
20	CANopen only: PDO length exceeded
21	Warning: Restart the controller to avoid future errors when saving (nonvolatile memory full/corrupt).
22	Rated current must be set (203B <sub>h</sub> :01 <sub>h</sub> /6075 <sub>h</sub> )
23	Encoder resolution, number of pole pairs and some other values are incorrect.
24	Motor current is too high, adjust the PI parameters.
25	Internal software error, generic
26	Current too high at digital output
27	CANopen only: Unexpected sync length
30	Error in speed monitoring: slippage error too large
32	Internal error: Correction factor for reference voltage missing in the OTP
39	Error in the ballast configuration: Invalid/unrealistic parameters entered (see <a href="#">Ballast monitoring</a> )
40	Warning: Ballast resistor thermally overloaded
46	Interlock error: Bit 3 in 60FD <sub>h</sub> is set to "0", the motor may not start (see the section <i>Interlock function</i> in the chapter <a href="#">Digital inputs</a> )

### Error Class[8]

This byte is identical to object [1001<sub>h</sub>](#)

### Error Code[16]

Refer to the following table for the meaning of the bytes.

Error Code	Description
1000 <sub>h</sub>	General error
2300 <sub>h</sub>	Current at the controller output too large
3100 <sub>h</sub>	Overvoltage/undervoltage at controller input
4200 <sub>h</sub>	Temperature error within the controller
5440 <sub>h</sub>	Interlock error: Bit 3 in 60FD <sub>h</sub> is set to "0", the motor may not start (see the section <i>Interlock function</i> in the chapter <a href="#">Digital inputs</a> )
6010 <sub>h</sub>	Software reset (watchdog)
6100 <sub>h</sub>	Internal software error, generic
6320 <sub>h</sub>	Rated current must be set (203B <sub>h</sub> :01 <sub>h</sub> /6075 <sub>h</sub> )
7110 <sub>h</sub>	Error in the ballast configuration: Invalid/unrealistic parameters entered (see <a href="#">Ballast monitoring</a> )
7113 <sub>h</sub>	Warning: Ballast resistor thermally overloaded
7121 <sub>h</sub>	Motor blocked
7200 <sub>h</sub>	Internal error: Correction factor for reference voltage missing in the OTP
7305 <sub>h</sub>	Sensor 1 (see <a href="#">3204<sub>h</sub></a> ) faulty
7306 <sub>h</sub>	Sensor 2 (see <a href="#">3204<sub>h</sub></a> ) faulty
7307 <sub>h</sub>	Sensor n (see <a href="#">3204<sub>h</sub></a> ), where n is greater than 2

Error Code	Description
7600 <sub>h</sub>	Warning: Nonvolatile memory full or corrupt; restart the controller for cleanup work
8100 <sub>h</sub>	Error during fieldbus monitoring
8130 <sub>h</sub>	CANopen only: "Life Guard" error or "Heartbeat" error
8200 <sub>h</sub>	CANopen only: Slave took too long to send PDO messages.
8210 <sub>h</sub>	CANopen only: PDO was not processed due to a length error
8220 <sub>h</sub>	CANopen only: PDO length exceeded
8240 <sub>h</sub>	CANopen only: unexpected sync length
8400 <sub>h</sub>	Error in speed monitoring: slippage error too large
8611 <sub>h</sub>	Position monitoring error: Following error too large
8612 <sub>h</sub>	Position monitoring error: Limit switch exceeded

## 1005h COB-ID Sync

### Function

Defines the COB-ID of the SYNC message for the SYNC protocol. The value must correspond to an 11-bit-long CAN-ID and is evaluated when the controller is restarted or on a Reset Communication command.

#### NOTICE



If the CAN-ID is not to correspond to the default value of 80<sub>h</sub>, it must be ensured that only not-yet unassigned or reserved CAN-IDs are used.

You can activate the generation of sync messages (the controller becomes the *sync master of the network*) by setting bit 30 to "1". Set the cycle time in object 1006<sub>h</sub>.

### Object description

Index	1005 <sub>h</sub>
Object name	COB-ID Sync
Object Code	VARIABLE
Data type	UNSIGNED32
Savable	yes, category: communication
Access	read / write
PDO mapping	no
Allowed values	
Preset value	00000080 <sub>h</sub>
Firmware version	FIR-v1426
Change history	

## 1006h Communication Cycle Period

### Function

Contains the cycle time for the generated sync messages (see [1005<sub>h</sub>](#)) in  $\mu$ s. Only multiples of 1000  $\mu$ s are permitted.

### Object description

---

Index	1006 <sub>h</sub>
Object name	Communication Cycle Period
Object Code	VARIABLE
Data type	UNSIGNED32
Savable	yes, category: communication
Access	read / write
PDO mapping	no
Allowed values	
Preset value	00000000 <sub>h</sub>
Firmware version	FIR-v2013-B726332
Change history	

---

## 1007h Synchronous Window Length

### Function

This object contains the length of the time window in microseconds for synchronous PDOs. If the synchronous time window has elapsed, all synchronous TxPDOs are rejected and an EMCY message sent. The RxPDOs are also rejected up to the next SYNC message.

The value "0" switches off the time window, thereby allowing the PDOs to be sent at any time.

This object is only available in device variants with CANopen connection.

### Object description

---

Index	1007 <sub>h</sub>
Object name	Synchronous Window Length
Object Code	VARIABLE
Data type	UNSIGNED32
Savable	yes, category: communication
Access	read / write
PDO mapping	no
Allowed values	
Preset value	00000000 <sub>h</sub>
Firmware version	FIR-v1426
Change history	

---



## 1008h Manufacturer Device Name

### Function

Contains the device name as character string.

### Object description

Index	1008 <sub>h</sub>
Object name	Manufacturer Device Name
Object Code	VARIABLE
Data type	VISIBLE_STRING
Savable	no
Access	read only
PDO mapping	no
Allowed values	
Preset value	NP5-08
Firmware version	FIR-v1426
Change history	

## 1009h Manufacturer Hardware Version

### Function

This object contains the hardware version as character string.

### Object description

Index	1009 <sub>h</sub>
Object name	Manufacturer Hardware Version
Object Code	VARIABLE
Data type	VISIBLE_STRING
Savable	no
Access	read only
PDO mapping	no
Allowed values	
Preset value	0
Firmware version	FIR-v1426
Change history	

## 100Ah Manufacturer Software Version

### Function

This object contains the software version as character string.

### Object description

Index	100A <sub>h</sub>
-------	-------------------

Object name	Manufacturer Software Version
Object Code	VARIABLE
Data type	VISIBLE_STRING
Savable	no
Access	read only
PDO mapping	no
Allowed values	
Preset value	FIR-v2213-B1029809
Firmware version	FIR-v1426
Change history	

---

## 100Ch Guard Time

### Function

Object 100C<sub>h</sub> multiplied by object [100Dh Live Time Factor](#) yields the so-called lifetime for the Lifeguarding / Nodeguarding protocol. The value is specified in milliseconds. See also [Nodeguarding](#).

#### NOTICE



The *Heartbeat protocol* has a higher priority than *Nodeguarding*. If both protocols are activated simultaneously, the Node Guarding Timer is suppressed, but no EMCY message is sent either.

---

### Object description

---

Index	100C <sub>h</sub>
Object name	Guard Time
Object Code	VARIABLE
Data type	UNSIGNED16
Savable	yes, category: communication
Access	read / write
PDO mapping	no
Allowed values	
Preset value	0000 <sub>h</sub>
Firmware version	FIR-v1426
Change history	

---

## 100Dh Live Time Factor

### Function

This object is a multiplier which, multiplied by object [100C<sub>h</sub>](#), yields the time window for the *Nodeguarding* protocol in milliseconds. See also [Nodeguarding](#).

#### NOTICE



The *Heartbeat protocol* has a higher priority than *Nodeguarding*. If both protocols are activated simultaneously, the Node Guarding Timer is suppressed, but no EMCY message is sent either.

---

This object is only available in device variants with CANopen connection.

## Object description

Index	100D <sub>h</sub>
Object name	Live Time Factor
Object Code	VARIABLE
Data type	UNSIGNED8
Savable	yes, category: communication
Access	read / write
PDO mapping	no
Allowed values	
Preset value	00 <sub>h</sub>
Firmware version	FIR-v1426
Change history	

## 1010h Store Parameters

### Function

This object is used to start the saving of objects. See chapter [Saving objects](#).

### Object description

Index	1010 <sub>h</sub>
Object name	Store Parameters
Object Code	ARRAY
Data type	UNSIGNED32
Savable	no
Access	read only
PDO mapping	no
Allowed values	
Preset value	
Firmware version	FIR-v1426
Change history	<p>Firmware version FIR-v1436: "Object name" entry changed from "Store Parameter" to "Store Parameters".</p> <p>Firmware version FIR-v1436: The number of entries was changed from 3 to 4.</p> <p>Firmware version FIR-v1512: The number of entries was changed from 4 to 5.</p> <p>Firmware version FIR-v1540: The number of entries was changed from 5 to 7.</p> <p>Firmware version FIR-v1738-B501312: The number of entries was changed from 7 to 14.</p>

## Value description

Subindex	00 <sub>h</sub>
Name	Number Of Entries
Data type	UNSIGNED8
Access	read only
PDO mapping	no
Allowed values	
Preset value	0D <sub>h</sub>

Subindex	01 <sub>h</sub>
Name	Save All Parameters To Non-volatile Memory
Data type	UNSIGNED32
Access	read / write
PDO mapping	no
Allowed values	
Preset value	00000001 <sub>h</sub>

Subindex	02 <sub>h</sub>
Name	Save Communication Parameters To Non-volatile Memory
Data type	UNSIGNED32
Access	read / write
PDO mapping	no
Allowed values	
Preset value	00000001 <sub>h</sub>

Subindex	03 <sub>h</sub>
Name	Save Application Parameters To Non-volatile Memory
Data type	UNSIGNED32
Access	read / write
PDO mapping	no
Allowed values	
Preset value	00000001 <sub>h</sub>

Subindex	04 <sub>h</sub>
Name	Save Customer Parameters To Non-volatile Memory
Data type	UNSIGNED32
Access	read / write
PDO mapping	no
Allowed values	
Preset value	00000001 <sub>h</sub>

Subindex	05 <sub>h</sub>
----------	-----------------

Name	Save Drive Parameters To Non-volatile Memory
Data type	UNSIGNED32
Access	read / write
PDO mapping	no
Allowed values	
Preset value	00000001 <sub>h</sub>
Subindex	06 <sub>h</sub>
Name	Save Tuning Parameters To Non-volatile Memory
Data type	UNSIGNED32
Access	read / write
PDO mapping	no
Allowed values	
Preset value	00000001 <sub>h</sub>
Subindex	07 <sub>h</sub>
Name	Save Miscellaneous Configurations To Non-volatile Memory
Data type	UNSIGNED32
Access	read / write
PDO mapping	no
Allowed values	
Preset value	00000001 <sub>h</sub>
Subindex	08 <sub>h</sub>
Name	Save Reserved1 Configurations To Non-volatile Memory
Data type	UNSIGNED32
Access	read / write
PDO mapping	no
Allowed values	
Preset value	00000000 <sub>h</sub>
Subindex	09 <sub>h</sub>
Name	Save Reserved2 Configurations To Non-volatile Memory
Data type	UNSIGNED32
Access	read / write
PDO mapping	no
Allowed values	
Preset value	00000000 <sub>h</sub>
Subindex	0A <sub>h</sub>
Name	Save CANopen Configurations To Non-volatile Memory
Data type	UNSIGNED32
Access	read / write

PDO mapping	no
Allowed values	
Preset value	00000001 <sub>h</sub>
<hr/>	
Subindex	0B <sub>h</sub>
Name	Save Modbus RTU Configurations To Non-volatile Memory
Data type	UNSIGNED32
Access	read / write
PDO mapping	no
Allowed values	
Preset value	00000001 <sub>h</sub>
<hr/>	
Subindex	0C <sub>h</sub>
Name	Save Ethernet Configurations To Non-volatile Memory
Data type	UNSIGNED32
Access	read / write
PDO mapping	no
Allowed values	
Preset value	00000001 <sub>h</sub>
<hr/>	
Subindex	0D <sub>h</sub>
Name	Save Profibus Configurations To Non-volatile Memory
Data type	UNSIGNED32
Access	read / write
PDO mapping	no
Allowed values	
Preset value	00000001 <sub>h</sub>

## Description

Each subindex of the object stands for a certain memory class. By reading out the entry, it is possible to determine whether (value "1") or not (value="0") this memory category can be saved.

To start the save process of a memory category, value "65766173<sub>h</sub>" must be written in the corresponding subindex. This corresponds to the decimal of 1702257011<sub>d</sub> or the ASCII string `save`. As soon as the saving process is completed, the save command is again overwritten with the value "1", since saving is possible again.

For a detailed description, see chapter [Saving objects](#).

## 1011h Restore Default Parameters

### Function

This object can be used to reset all or part of the object dictionary to the default values. See chapter [Saving objects](#).

## Object description

Index	1011 <sub>h</sub>
Object name	Restore Default Parameters
Object Code	ARRAY
Data type	UNSIGNED32
Savable	no
Access	read only
PDO mapping	no
Allowed values	
Preset value	
Firmware version	FIR-v1426
Change history	<p>Firmware version FIR-v1436: "Object Name" entry changed from "Restore Default Parameter" to "Restore Default Parameters".</p> <p>Firmware version FIR-v1436: The number of entries was changed from 2 to 4.</p> <p>Firmware version FIR-v1512: The number of entries was changed from 4 to 5.</p> <p>Firmware version FIR-v1512: "Name" entry changed from "Restore The Comm Default Parameters" to "Restore Communication Default Parameters".</p> <p>Firmware version FIR-v1512: "Name" entry changed from "Restore The Application Default Parameters" to "Restore Application Default Parameters".</p> <p>Firmware version FIR-v1540: The number of entries was changed from 5 to 7.</p> <p>Firmware version FIR-v1738-B501312: The number of entries was changed from 7 to 14.</p>

## Value description

Subindex	00 <sub>h</sub>
Name	Number Of Entries
Data type	UNSIGNED8
Access	read only
PDO mapping	no
Allowed values	
Preset value	0D <sub>h</sub>
Subindex	01 <sub>h</sub>
Name	Restore All Default Parameters
Data type	UNSIGNED32
Access	read / write
PDO mapping	no
Allowed values	
Preset value	00000001 <sub>h</sub>

Subindex	02 <sub>h</sub>
Name	Restore Communication Default Parameters
Data type	UNSIGNED32
Access	read / write
PDO mapping	no
Allowed values	
Preset value	00000001 <sub>h</sub>
Subindex	03 <sub>h</sub>
Name	Restore Application Default Parameters
Data type	UNSIGNED32
Access	read / write
PDO mapping	no
Allowed values	
Preset value	00000001 <sub>h</sub>
Subindex	04 <sub>h</sub>
Name	Restore Customer Default Parameters
Data type	UNSIGNED32
Access	read / write
PDO mapping	no
Allowed values	
Preset value	00000001 <sub>h</sub>
Subindex	05 <sub>h</sub>
Name	Restore Drive Default Parameters
Data type	UNSIGNED32
Access	read / write
PDO mapping	no
Allowed values	
Preset value	00000001 <sub>h</sub>
Subindex	06 <sub>h</sub>
Name	Restore Tuning Default Parameters
Data type	UNSIGNED32
Access	read / write
PDO mapping	no
Allowed values	
Preset value	00000001 <sub>h</sub>
Subindex	07 <sub>h</sub>
Name	Restore Miscellaneous Configurations
Data type	UNSIGNED32



Access	read / write
PDO mapping	no
Allowed values	
Preset value	00000001 <sub>h</sub>

---

Subindex	08 <sub>h</sub>
Name	Restore Reserved1 Configurations To Non-volatile Memory
Data type	UNSIGNED32
Access	read / write
PDO mapping	no
Allowed values	
Preset value	00000000 <sub>h</sub>

---

Subindex	09 <sub>h</sub>
Name	Restore Reserved2 Configurations To Non-volatile Memory
Data type	UNSIGNED32
Access	read / write
PDO mapping	no
Allowed values	
Preset value	00000000 <sub>h</sub>

---

Subindex	0A <sub>h</sub>
Name	Restore CANopen Configurations To Non-volatile Memory
Data type	UNSIGNED32
Access	read / write
PDO mapping	no
Allowed values	
Preset value	00000001 <sub>h</sub>

---

Subindex	0B <sub>h</sub>
Name	Restore Modbus RTU Configurations To Non-volatile Memory
Data type	UNSIGNED32
Access	read / write
PDO mapping	no
Allowed values	
Preset value	00000001 <sub>h</sub>

---

Subindex	0C <sub>h</sub>
Name	Restore Ethernet Configurations To Non-volatile Memory
Data type	UNSIGNED32
Access	read / write
PDO mapping	no
Allowed values	

Preset value	00000001 <sub>h</sub>
Subindex	0D <sub>h</sub>
Name	Restore Profibus Configurations To Non-volatile Memory
Data type	UNSIGNED32
Access	read / write
PDO mapping	no
Allowed values	
Preset value	00000001 <sub>h</sub>

## Description

If the value 64616F6C<sub>h</sub> (or 1684107116<sub>d</sub> or ASCII `load`) is written in this object, part or all of the object dictionary is reset to the default values. The subindex that is used decides which range is reset.

For a detailed description, see chapter [Discarding the saved data](#).

## 1014h COB-ID EMCY

### Function

This object describes the COB-ID of the "Emergency Service" under CANopen.

With the *Valid Bit* (bit 31) = "1", the [Emergency Service](#) can be deactivated; the service is active with the value "0". Every time the controller is restarted, bits 0 to 30 are generated according to the node-ID.

### Object description

Index	1014 <sub>h</sub>
Object name	COB-ID EMCY
Object Code	VARIABLE
Data type	UNSIGNED32
Savable	yes, category: communication
Access	read / write
PDO mapping	no
Allowed values	
Preset value	00000000 <sub>h</sub>
Firmware version	FIR-v1426
Change history	Firmware version FIR-v1540: "Access" table entry for subindex 00 changed from "read only" to "read/write".

## 1016h Consumer Heartbeat Time

### Function

This object defines the cycle time of the *Consumer Heartbeat* of the *Network Management* CANopen service and the Node-ID of the *Producer* of the *Heartbeat*.

If the cycle time or node-ID is set to the value 0, there is no response to the Heartbeat message. See also chapter [Heartbeat](#).

## Object description

Index	1016 <sub>h</sub>
Object name	Consumer Heartbeat Time
Object Code	ARRAY
Data type	UNSIGNED32
Savable	yes, category: communication
Access	read only
PDO mapping	no
Allowed values	
Preset value	
Firmware version	FIR-v1738-B501312
Change history	

## Value description

Subindex	00 <sub>h</sub>
Name	Number Of Entries
Data type	UNSIGNED8
Access	read only
PDO mapping	no
Allowed values	
Preset value	01 <sub>h</sub>

Subindex	01 <sub>h</sub>
Name	Consumer Heartbeat Time
Data type	UNSIGNED32
Access	read / write
PDO mapping	no
Allowed values	
Preset value	00000000 <sub>h</sub>

## Description

Subindex 01<sub>h</sub> contains:

- Bits 0 to 15: The time of the *Consumer Heartbeat* in ms.
- Bits 16 to 23: The node-ID of the *Producer* whose *Heartbeat* is to be monitored.

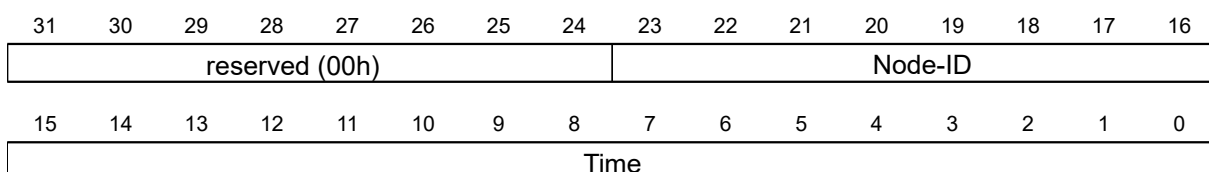

## 1017h Producer Heartbeat Time

### Function

This object defines the cycle time of the *Heartbeat* of the *Network Management* CANopen service in milliseconds. If the object is set to the value 0, no Heartbeat message is sent. See also [Heartbeat](#).

#### NOTICE



The *Heartbeat protocol* has a higher priority than *Nodeguarding*. If both protocols are activated simultaneously, the Node Guarding Timer is suppressed, but no EMCY message is sent either.

This object is only available in device variants with CANopen connection.

### Object description

Index	1017 <sub>h</sub>
Object name	Producer Heartbeat Time
Object Code	VARIABLE
Data type	UNSIGNED16
Savable	yes, category: communication
Access	read / write
PDO mapping	no
Allowed values	
Preset value	0000 <sub>h</sub>
Firmware version	FIR-v1426
Change history	

## 1018h Identity Object

### Function

This object returns general information on the device, such as manufacturer, product code, revision and serial number.



#### TIP

Have these values ready in the event of service inquiries.

### Object description

Index	1018 <sub>h</sub>
Object name	Identity Object
Object Code	RECORD
Data type	IDENTITY
Savable	no
Firmware version	FIR-v1426
Change history	

## Value description

Subindex	00 <sub>h</sub>
Name	Number Of Entries
Data type	UNSIGNED8
Access	read only
PDO mapping	no
Allowed values	
Preset value	04 <sub>h</sub>

Subindex	01 <sub>h</sub>
Name	Vendor-ID
Data type	UNSIGNED32
Access	read only
PDO mapping	no
Allowed values	
Preset value	0000026C <sub>h</sub>

Subindex	02 <sub>h</sub>
Name	Product Code
Data type	UNSIGNED32
Access	read only
PDO mapping	no
Allowed values	
Preset value	00000024 <sub>h</sub>

Subindex	03 <sub>h</sub>
Name	Revision Number
Data type	UNSIGNED32
Access	read only
PDO mapping	no
Allowed values	
Preset value	08A50000 <sub>h</sub>

Subindex	04 <sub>h</sub>
Name	Serial Number
Data type	UNSIGNED32
Access	read only
PDO mapping	no
Allowed values	
Preset value	00000000 <sub>h</sub>

## 1019h Synchronous Counter Overflow Value

### Function

The value from which the *Sync Counter* is to begin counting anew is entered here. See chapter [Synchronization object \(SYNC\)](#).

### Object description

Index	1019 <sub>h</sub>
Object name	Synchronous Counter Overflow Value
Object Code	VARIABLE
Data type	UNSIGNED8
Savable	yes, category: communication
Access	read / write
PDO mapping	no
Allowed values	
Preset value	00 <sub>h</sub>
Firmware version	FIR-v1426
Change history	<p>Firmware Version FIR-v1738-B501312: "Object Name" entry changed from "Synchronous counter overflow value" to "Synchronous Counter Overflow Value".</p> <p>Firmware version FIR-v1738-B501312: "Data type" entry changed from "UNSIGNED16" to "UNSIGNED8".</p>

### Description

Allowed values: 02<sub>h</sub> to F0<sub>h</sub>.

## 1020h Verify Configuration

### Function

This object indicates the date and time that the configuration was stored.

A configuration tool or a master can use this object to verify the configuration after a reset and, if necessary, perform a new configuration.

The tool must set the date and time before the storage mechanism is started (see chapter [Saving objects](#)).

### Object description

Index	1020 <sub>h</sub>
Object name	Verify Configuration
Object Code	ARRAY
Data type	UNSIGNED32
Savable	yes, category: verify
Access	read only
PDO mapping	no
Allowed values	
Preset value	
Firmware version	FIR-v1540

Change history

---

## Value description

Subindex	00 <sub>h</sub>
Name	Number Of Entries
Data type	UNSIGNED8
Access	read only
PDO mapping	no
Allowed values	
Preset value	02 <sub>h</sub>

Subindex	01 <sub>h</sub>
Name	Configuration Date
Data type	UNSIGNED32
Access	read / write
PDO mapping	no
Allowed values	
Preset value	00000000 <sub>h</sub>

Subindex	02 <sub>h</sub>
Name	Configuration Time
Data type	UNSIGNED32
Access	read / write
PDO mapping	no
Allowed values	
Preset value	00000000 <sub>h</sub>

## Description

Subindex 01<sub>h</sub> (configuration date) is to contain the number of days since 1 January 1984.

Subindex 02<sub>h</sub> (configuration time) is to contain the number of milliseconds since midnight.

## 1029h Error Behavior

### Function

This object is used to define what the *NMT state* of the controller should be in case of an error. See also chapter [Network Management \(NMT\)](#).

## Object description

Index	1029 <sub>h</sub>
Object name	Error Behavior
Object Code	ARRAY
Data type	UNSIGNED8
Savable	yes, category: communication

Access	read only
PDO mapping	no
Allowed values	
Preset value	
Firmware version	FIR-v1738-B501312
Change history	

---

## Value description

Subindex	00 <sub>h</sub>
Name	Number Of Entries
Data type	UNSIGNED8
Access	read only
PDO mapping	no
Allowed values	
Preset value	02 <sub>h</sub>

---

Subindex	01 <sub>h</sub>
Name	Communication Error
Data type	UNSIGNED8
Access	read / write
PDO mapping	no
Allowed values	
Preset value	00 <sub>h</sub>

---

Subindex	02 <sub>h</sub>
Name	Internal Device Error
Data type	UNSIGNED8
Access	read / write
PDO mapping	no
Allowed values	
Preset value	01 <sub>h</sub>

---

## Description

The subindices have the following function:

- 01<sub>h</sub>: This subindex is used to define how to respond in case of a communication error:
  - Value "00"<sub>h</sub>: The controller switches to the *Pre-Operational* state (if previously in the *Operational* state).
  - Value "01"<sub>h</sub>: The controller does not change state.
  - Value "02"<sub>h</sub>: The controller switches to the *Stopped* state.
- 02<sub>h</sub>: This subindex is used to define how to respond to the remaining errors (except for communication errors):
  - Value "00"<sub>h</sub>: The controller switches to the *Pre-Operational* state (if previously in the *Operational* state).
  - Value "01"<sub>h</sub>: The controller does not change state.



- Value "02"<sub>h</sub>: The controller switches to the *Stopped* state.

## 1400h Receive PDO 1 Communication Parameter

### Function

Contains the communication parameters for the receiving-side mapping (RX-PDO) in object 1600<sub>h</sub>. See chapter [Process Data Object \(PDO\)](#).

### Object description

Index	1400 <sub>h</sub>
Object name	Receive PDO 1 Communication Parameter
Object Code	RECORD
Data type	PDO_COMMUNICATION_PARAMETER
Savable	yes, category: communication
Firmware version	FIR-v1426
Change history	

### Value description

Subindex	00 <sub>h</sub>
Name	Number Of Entries
Data type	UNSIGNED8
Access	read only
PDO mapping	no
Allowed values	
Preset value	02 <sub>h</sub>

Subindex	01 <sub>h</sub>
Name	COB-ID
Data type	UNSIGNED32
Access	read / write
PDO mapping	no
Allowed values	
Preset value	00000000 <sub>h</sub>

Subindex	02 <sub>h</sub>
Name	Transmission Type
Data type	UNSIGNED8
Access	read / write
PDO mapping	no
Allowed values	
Preset value	FF <sub>h</sub>

## Description

Subindex 01<sub>h</sub> (COB-ID): The COB-ID is stored here.

Subindex 02<sub>h</sub> (transmission type): A number is stored in this subindex that defines the time at which the received data become valid.

For details see chapter on [configuring the RX-PDO mapping](#).

## 1401h Receive PDO 2 Communication Parameter

### Function

Contains the communication parameters for the receiving-side mapping (RX-PDO) in object 1601<sub>h</sub>. See chapter [Process Data Object \(PDO\)](#).

### Object description

Index	1401 <sub>h</sub>
Object name	Receive PDO 2 Communication Parameter
Object Code	RECORD
Data type	PDO_COMMUNICATION_PARAMETER
Savable	yes, category: communication
Firmware version	FIR-v1426
Change history	

### Value description

Subindex	00 <sub>h</sub>
Name	Number Of Entries
Data type	UNSIGNED8
Access	read only
PDO mapping	no
Allowed values	
Preset value	02 <sub>h</sub>

Subindex	01 <sub>h</sub>
Name	COB-ID
Data type	UNSIGNED32
Access	read / write
PDO mapping	no
Allowed values	
Preset value	00000000 <sub>h</sub>

Subindex	02 <sub>h</sub>
Name	Transmission Type
Data type	UNSIGNED8
Access	read / write
PDO mapping	no

Allowed values

Preset value FF<sub>h</sub>

## Description

Subindex 01<sub>h</sub> (COB-ID): The COB-ID is stored here.

Subindex 02<sub>h</sub> (transmission type): A number is stored in this subindex that defines the time at which the received data become valid.

For details see chapter on [configuring the RX-PDO mapping](#).

## 1402h Receive PDO 3 Communication Parameter

### Function

Contains the communication parameters for the receiving-side mapping (RX-PDO) in object 1602<sub>h</sub>. See chapter [Process Data Object \(PDO\)](#).

### Object description

Index	1402 <sub>h</sub>
Object name	Receive PDO 3 Communication Parameter
Object Code	RECORD
Data type	PDO_COMMUNICATION_PARAMETER
Savable	yes, category: communication
Firmware version	FIR-v1426
Change history	

### Value description

Subindex	00 <sub>h</sub>
Name	Number Of Entries
Data type	UNSIGNED8
Access	read only
PDO mapping	no
Allowed values	
Preset value	02 <sub>h</sub>

Subindex	01 <sub>h</sub>
Name	COB-ID
Data type	UNSIGNED32
Access	read / write
PDO mapping	no
Allowed values	
Preset value	00000000 <sub>h</sub>

Subindex	02 <sub>h</sub>
Name	Transmission Type

Data type	UNSIGNED8
Access	read / write
PDO mapping	no
Allowed values	
Preset value	FF <sub>h</sub>

---

## Description

Subindex 01<sub>h</sub> (COB-ID): The COB-ID is stored here.

Subindex 02<sub>h</sub> (transmission type): A number is stored in this subindex that defines the time at which the received data become valid.

For details see chapter on [configuring the RX-PDO mapping](#).

## 1403h Receive PDO 4 Communication Parameter

### Function

Contains the communication parameters for the receiving-side mapping (RX-PDO) in object 1603<sub>h</sub>. See chapter [Process Data Object \(PDO\)](#).

### Object description

Index	1403 <sub>h</sub>
Object name	Receive PDO 4 Communication Parameter
Object Code	RECORD
Data type	PDO_COMMUNICATION_PARAMETER
Savable	yes, category: communication
Firmware version	FIR-v1426
Change history	

---

### Value description

Subindex	00 <sub>h</sub>
Name	Number Of Entries
Data type	UNSIGNED8
Access	read only
PDO mapping	no
Allowed values	
Preset value	02 <sub>h</sub>

---

Subindex	01 <sub>h</sub>
Name	COB-ID
Data type	UNSIGNED32
Access	read / write
PDO mapping	no
Allowed values	
Preset value	00000000 <sub>h</sub>

---

Subindex	02 <sub>h</sub>
Name	Transmission Type
Data type	UNSIGNED8
Access	read / write
PDO mapping	no
Allowed values	
Preset value	FF <sub>h</sub>

## Description

Subindex 01<sub>h</sub> (COB-ID): The COB-ID is stored here.

Subindex 02<sub>h</sub> (transmission type): A number is stored in this subindex that defines the time at which the received data become valid.

For details see chapter on [configuring the RX-PDO mapping](#).

## 1404h Receive PDO 5 Communication Parameter

### Function

Contains the communication parameters for the receiving-side mapping (RX-PDO) in object 1604<sub>h</sub>. See chapter [Process Data Object \(PDO\)](#).

### Object description

Index	1404 <sub>h</sub>
Object name	Receive PDO 5 Communication Parameter
Object Code	RECORD
Data type	PDO_COMMUNICATION_PARAMETER
Savable	yes, category: communication
Access	read only
PDO mapping	no
Allowed values	
Preset value	
Firmware version	FIR-v1614
Change history	

### Value description

Subindex	00 <sub>h</sub>
Name	Number Of Entries
Data type	UNSIGNED8
Access	read only
PDO mapping	no
Allowed values	
Preset value	02 <sub>h</sub>

Subindex	01 <sub>h</sub>
----------	-----------------

Name	COB-ID
Data type	UNSIGNED32
Access	read / write
PDO mapping	no
Allowed values	
Preset value	80000000 <sub>h</sub>

---

Subindex	02 <sub>h</sub>
Name	Transmission Type
Data type	UNSIGNED8
Access	read / write
PDO mapping	no
Allowed values	
Preset value	FF <sub>h</sub>

## Description

Subindex 01<sub>h</sub> (COB-ID): The COB-ID is stored here.

Subindex 02<sub>h</sub> (transmission type): A number is stored in this subindex that defines the time at which the received data become valid.

For details see chapter on [configuring the RX-PDO mapping](#).

## 1405h Receive PDO 6 Communication Parameter

### Function

Contains the communication parameters for the receiving-side mapping (RX-PDO) in object 1605<sub>h</sub>. See chapter [Process Data Object \(PDO\)](#).

### Object description

---

Index	1405 <sub>h</sub>
Object name	Receive PDO 6 Communication Parameter
Object Code	RECORD
Data type	PDO_COMMUNICATION_PARAMETER
Savable	yes, category: communication
Access	read only
PDO mapping	no
Allowed values	
Preset value	
Firmware version	FIR-v1614
Change history	

### Value description

---

Subindex	00 <sub>h</sub>
Name	Number Of Entries

Data type	UNSIGNED8
Access	read only
PDO mapping	no
Allowed values	
Preset value	02 <sub>h</sub>

Subindex	01 <sub>h</sub>
Name	COB-ID
Data type	UNSIGNED32
Access	read / write
PDO mapping	no
Allowed values	
Preset value	80000000 <sub>h</sub>

Subindex	02 <sub>h</sub>
Name	Transmission Type
Data type	UNSIGNED8
Access	read / write
PDO mapping	no
Allowed values	
Preset value	FF <sub>h</sub>

## Description

Subindex 01<sub>h</sub> (COB-ID): The COB-ID is stored here.

Subindex 02<sub>h</sub> (transmission type): A number is stored in this subindex that defines the time at which the received data become valid.

For details see chapter on [configuring the RX-PDO mapping](#).

## 1406h Receive PDO 7 Communication Parameter

### Function

Contains the communication parameters for the receiving-side mapping (RX-PDO) in object 1606<sub>h</sub>. See chapter [Process Data Object \(PDO\)](#).

### Object description

Index	1406 <sub>h</sub>
Object name	Receive PDO 7 Communication Parameter
Object Code	RECORD
Data type	PDO_COMMUNICATION_PARAMETER
Savable	yes, category: communication
Access	read only
PDO mapping	no
Allowed values	
Preset value	

Firmware version	FIR-v1614
Change history	

---

## Value description

Subindex	00 <sub>h</sub>
Name	Number Of Entries
Data type	UNSIGNED8
Access	read only
PDO mapping	no
Allowed values	
Preset value	02 <sub>h</sub>

---

Subindex	01 <sub>h</sub>
Name	COB-ID
Data type	UNSIGNED32
Access	read / write
PDO mapping	no
Allowed values	
Preset value	80000000 <sub>h</sub>

---

Subindex	02 <sub>h</sub>
Name	Transmission Type
Data type	UNSIGNED8
Access	read / write
PDO mapping	no
Allowed values	
Preset value	FF <sub>h</sub>

---

## Description

Subindex 01<sub>h</sub> (COB-ID): The COB-ID is stored here.

Subindex 02<sub>h</sub> (transmission type): A number is stored in this subindex that defines the time at which the received data become valid.

For details see chapter on [configuring the RX-PDO mapping](#).

## 1407h Receive PDO 8 Communication Parameter

### Function

Contains the communication parameters for the receiving-side mapping (RX-PDO) in object 1607<sub>h</sub>. See chapter [Process Data Object \(PDO\)](#).

### Object description

Index	1407 <sub>h</sub>
Object name	Receive PDO 8 Communication Parameter



Object Code	RECORD
Data type	PDO_COMMUNICATION_PARAMETER
Savable	yes, category: communication
Access	read only
PDO mapping	no
Allowed values	
Preset value	
Firmware version	FIR-v1614
Change history	

---

## Value description

Subindex	00 <sub>h</sub>
Name	Number Of Entries
Data type	UNSIGNED8
Access	read only
PDO mapping	no
Allowed values	
Preset value	02 <sub>h</sub>

---

Subindex	01 <sub>h</sub>
Name	COB-ID
Data type	UNSIGNED32
Access	read / write
PDO mapping	no
Allowed values	
Preset value	80000000 <sub>h</sub>

---

Subindex	02 <sub>h</sub>
Name	Transmission Type
Data type	UNSIGNED8
Access	read / write
PDO mapping	no
Allowed values	
Preset value	FF <sub>h</sub>

---

## Description

Subindex 01<sub>h</sub> (COB-ID): The COB-ID is stored here.

Subindex 02<sub>h</sub> (transmission type): A number is stored in this subindex that defines the time at which the received data become valid.

For details see chapter on [configuring the RX-PDO mapping](#).

## 1600h Receive PDO 1 Mapping Parameter

### Function

This object contains the mapping parameters for PDOs that the controller can receive (RX-PDO 1). The PDO was previously configured via [1400h Receive PDO 1 Communication Parameter](#). See chapter [Process Data Object \(PDO\)](#).

### Object description

Index	1600 <sub>h</sub>
Object name	Receive PDO 1 Mapping Parameter
Object Code	RECORD
Data type	PDO_MAPPING
Savable	yes, category: communication
Firmware version	FIR-v1426
Change history	Firmware version FIR-v1426: "Heading" entry changed from "1600h Drive Control" to "1600h Receive PDO 1 Mapping Parameter". Firmware version FIR-v1426: "Object Name" entry changed from "Drive Control" to "Receive PDO 1 Mapping Parameter".

### Value description

Subindex	00 <sub>h</sub>
Name	Number Of Entries
Data type	UNSIGNED8
Access	read / write
PDO mapping	no
Allowed values	
Preset value	02 <sub>h</sub>

Subindex	01 <sub>h</sub>
Name	1st Object To Be Mapped
Data type	UNSIGNED32
Access	read / write
PDO mapping	no
Allowed values	
Preset value	60400010 <sub>h</sub>

Subindex	02 <sub>h</sub>
Name	2nd Object To Be Mapped
Data type	UNSIGNED32
Access	read / write
PDO mapping	no
Allowed values	
Preset value	60600008 <sub>h</sub>

---

Subindex	03 <sub>h</sub>
Name	3rd Object To Be Mapped
Data type	UNSIGNED32
Access	read / write
PDO mapping	no
Allowed values	
Preset value	00000000 <sub>h</sub>

---



---

Subindex	04 <sub>h</sub>
Name	4th Object To Be Mapped
Data type	UNSIGNED32
Access	read / write
PDO mapping	no
Allowed values	
Preset value	00000000 <sub>h</sub>

---



---

Subindex	05 <sub>h</sub>
Name	5th Object To Be Mapped
Data type	UNSIGNED32
Access	read / write
PDO mapping	no
Allowed values	
Preset value	00000000 <sub>h</sub>

---



---

Subindex	06 <sub>h</sub>
Name	6th Object To Be Mapped
Data type	UNSIGNED32
Access	read / write
PDO mapping	no
Allowed values	
Preset value	00000000 <sub>h</sub>

---



---

Subindex	07 <sub>h</sub>
Name	7th Object To Be Mapped
Data type	UNSIGNED32
Access	read / write
PDO mapping	no
Allowed values	
Preset value	00000000 <sub>h</sub>

---



---

Subindex	08 <sub>h</sub>
Name	8th Object To Be Mapped
Data type	UNSIGNED32

---

Access	read / write
PDO mapping	no
Allowed values	
Preset value	00000000 <sub>h</sub>

---

## Description

Each subindex (1–8) describes a different mapped object.

A mapping entry consists of four bytes, which are structured according to the following graphic.

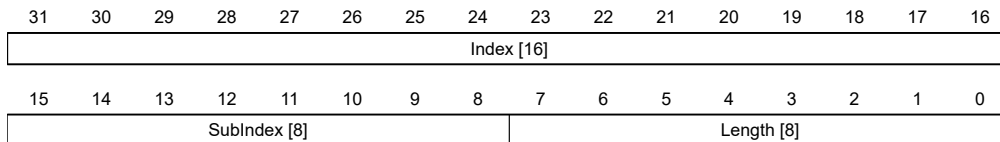

### Index [16]

This contains the index of the object to be mapped.

### Subindex [8]

This contains the subindex of the object to be mapped.

### Length [8]

This contains the length of the object to be mapped in units of bits.

## 1601h Receive PDO 2 Mapping Parameter

### Function

This object contains the mapping parameters for PDOs that the controller can receive (RX-PDO 2). The PDO was previously configured via [1401h Receive PDO 2 Communication Parameter](#). See chapter [Process Data Object \(PDO\)](#).

### Object description

---

Index	1601 <sub>h</sub>
Object name	Receive PDO 2 Mapping Parameter
Object Code	RECORD
Data type	PDO_MAPPING
Savable	yes, category: communication
Firmware version	FIR-v1426
Change history	Firmware version FIR-v1426: "Heading" entry changed from "1601h Positioning Control" to "1601h Receive PDO 2 Mapping Parameter".  Firmware version FIR-v1426: "Object Name" entry changed from "Positioning Control" to "Receive PDO 2 Mapping Parameter".

---

### Value description

---

Subindex	00 <sub>h</sub>
Name	Number Of Entries
Data type	UNSIGNED8

Access	read / write
PDO mapping	no
Allowed values	
Preset value	02 <sub>h</sub>

---

Subindex	01 <sub>h</sub>
Name	1st Object To Be Mapped
Data type	UNSIGNED32
Access	read / write
PDO mapping	no
Allowed values	
Preset value	607A0020 <sub>h</sub>

---

Subindex	02 <sub>h</sub>
Name	2nd Object To Be Mapped
Data type	UNSIGNED32
Access	read / write
PDO mapping	no
Allowed values	
Preset value	60810020 <sub>h</sub>

---

Subindex	03 <sub>h</sub>
Name	3rd Object To Be Mapped
Data type	UNSIGNED32
Access	read / write
PDO mapping	no
Allowed values	
Preset value	00000000 <sub>h</sub>

---

Subindex	04 <sub>h</sub>
Name	4th Object To Be Mapped
Data type	UNSIGNED32
Access	read / write
PDO mapping	no
Allowed values	
Preset value	00000000 <sub>h</sub>

---

Subindex	05 <sub>h</sub>
Name	5th Object To Be Mapped
Data type	UNSIGNED32
Access	read / write
PDO mapping	no
Allowed values	

Preset value	00000000 <sub>h</sub>
<hr/>	
Subindex	06 <sub>h</sub>
Name	6th Object To Be Mapped
Data type	UNSIGNED32
Access	read / write
PDO mapping	no
Allowed values	
Preset value	00000000 <sub>h</sub>
<hr/>	
Subindex	07 <sub>h</sub>
Name	7th Object To Be Mapped
Data type	UNSIGNED32
Access	read / write
PDO mapping	no
Allowed values	
Preset value	00000000 <sub>h</sub>
<hr/>	
Subindex	08 <sub>h</sub>
Name	8th Object To Be Mapped
Data type	UNSIGNED32
Access	read / write
PDO mapping	no
Allowed values	
Preset value	00000000 <sub>h</sub>

### Description

Each subindex (1–8) describes a different mapped object.

A mapping entry consists of four bytes, which are structured according to the following graphic.

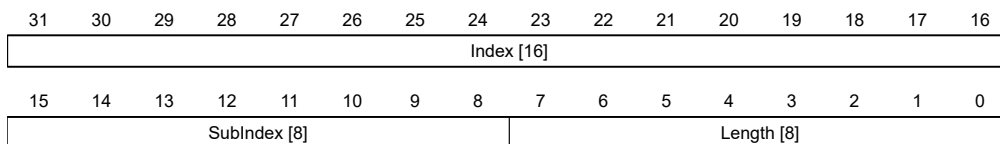

#### Index [16]

This contains the index of the object to be mapped.

#### Subindex [8]

This contains the subindex of the object to be mapped.

#### Length [8]

This contains the length of the object to be mapped in units of bits.

## 1602h Receive PDO 3 Mapping Parameter

### Function

This object contains the mapping parameters for PDOs that the controller can receive (RX-PDO 3). The PDO was previously configured via [1402h Receive PDO 3 Communication Parameter](#). See chapter [Process Data Object \(PDO\)](#).

### Object description

Index	1602 <sub>h</sub>
Object name	Receive PDO 3 Mapping Parameter
Object Code	RECORD
Data type	PDO_MAPPING
Savable	yes, category: communication
Firmware version	FIR-v1426
Change history	Firmware version FIR-v1426: "Heading" entry changed from "1602h Velocity Control" to "1602h Receive PDO 3 Mapping Parameter". Firmware version FIR-v1426: "Object Name" entry changed from "Velocity Control" to "Receive PDO 3 Mapping Parameter".

### Value description

Subindex	00 <sub>h</sub>
Name	Number Of Entries
Data type	UNSIGNED8
Access	read / write
PDO mapping	no
Allowed values	
Preset value	01 <sub>h</sub>

Subindex	01 <sub>h</sub>
Name	1st Object To Be Mapped
Data type	UNSIGNED32
Access	read / write
PDO mapping	no
Allowed values	
Preset value	60420010 <sub>h</sub>

Subindex	02 <sub>h</sub>
Name	2nd Object To Be Mapped
Data type	UNSIGNED32
Access	read / write
PDO mapping	no
Allowed values	
Preset value	00000000 <sub>h</sub>

---

Subindex	03 <sub>h</sub>
Name	3rd Object To Be Mapped
Data type	UNSIGNED32
Access	read / write
PDO mapping	no
Allowed values	
Preset value	00000000 <sub>h</sub>

---



---

Subindex	04 <sub>h</sub>
Name	4th Object To Be Mapped
Data type	UNSIGNED32
Access	read / write
PDO mapping	no
Allowed values	
Preset value	00000000 <sub>h</sub>

---



---

Subindex	05 <sub>h</sub>
Name	5th Object To Be Mapped
Data type	UNSIGNED32
Access	read / write
PDO mapping	no
Allowed values	
Preset value	00000000 <sub>h</sub>

---



---

Subindex	06 <sub>h</sub>
Name	6th Object To Be Mapped
Data type	UNSIGNED32
Access	read / write
PDO mapping	no
Allowed values	
Preset value	00000000 <sub>h</sub>

---



---

Subindex	07 <sub>h</sub>
Name	7th Object To Be Mapped
Data type	UNSIGNED32
Access	read / write
PDO mapping	no
Allowed values	
Preset value	00000000 <sub>h</sub>

---



---

Subindex	08 <sub>h</sub>
Name	8th Object To Be Mapped
Data type	UNSIGNED32

---



Access	read / write
PDO mapping	no
Allowed values	
Preset value	00000000 <sub>h</sub>

---

## 1603h Receive PDO 4 Mapping Parameter

### Function

This object contains the mapping parameters for PDOs that the controller can receive (RX-PDO 4). The PDO was previously configured via [1403h Receive PDO 4 Communication Parameter](#). See chapter [Process Data Object \(PDO\)](#).

### Object description

Index	1603 <sub>h</sub>
Object name	Receive PDO 4 Mapping Parameter
Object Code	RECORD
Data type	PDO_MAPPING
Savable	yes, category: communication
Firmware version	FIR-v1426
Change history	Firmware version FIR-v1426: "Heading" entry changed from "1603h Output Control" to "1603h Receive PDO 4 Mapping Parameter". Firmware version FIR-v1426: "Object Name" entry changed from "Output Control" to "Receive PDO 4 Mapping Parameter".

---

### Value description

Subindex	00 <sub>h</sub>
Name	Number Of Entries
Data type	UNSIGNED8
Access	read / write
PDO mapping	no
Allowed values	
Preset value	01 <sub>h</sub>

---

Subindex	01 <sub>h</sub>
Name	1st Object To Be Mapped
Data type	UNSIGNED32
Access	read / write
PDO mapping	no
Allowed values	
Preset value	60FE0120 <sub>h</sub>

---

Subindex	02 <sub>h</sub>
----------	-----------------

---

Name	2nd Object To Be Mapped
Data type	UNSIGNED32
Access	read / write
PDO mapping	no
Allowed values	
Preset value	00000000 <sub>h</sub>

---

Subindex	03 <sub>h</sub>
Name	3rd Object To Be Mapped
Data type	UNSIGNED32
Access	read / write
PDO mapping	no
Allowed values	
Preset value	00000000 <sub>h</sub>

---

Subindex	04 <sub>h</sub>
Name	4th Object To Be Mapped
Data type	UNSIGNED32
Access	read / write
PDO mapping	no
Allowed values	
Preset value	00000000 <sub>h</sub>

---

Subindex	05 <sub>h</sub>
Name	5th Object To Be Mapped
Data type	UNSIGNED32
Access	read / write
PDO mapping	no
Allowed values	
Preset value	00000000 <sub>h</sub>

---

Subindex	06 <sub>h</sub>
Name	6th Object To Be Mapped
Data type	UNSIGNED32
Access	read / write
PDO mapping	no
Allowed values	
Preset value	00000000 <sub>h</sub>

---

Subindex	07 <sub>h</sub>
Name	7th Object To Be Mapped
Data type	UNSIGNED32
Access	read / write

PDO mapping	no
Allowed values	
Preset value	00000000 <sub>h</sub>

---

Subindex	08 <sub>h</sub>
Name	8th Object To Be Mapped
Data type	UNSIGNED32
Access	read / write
PDO mapping	no
Allowed values	
Preset value	00000000 <sub>h</sub>

---

## 1604h Receive PDO 5 Mapping Parameter

### Function

This object contains the mapping parameters for PDOs that the controller can receive (RX-PDO 5). The PDO was previously configured via [1404h Receive PDO 5 Communication Parameter](#). See chapter [Process Data Object \(PDO\)](#).

### Object description

Index	1604 <sub>h</sub>
Object name	Receive PDO 5 Mapping Parameter
Object Code	RECORD
Data type	PDO_MAPPING
Savable	yes, category: communication
Access	read / write
PDO mapping	no
Allowed values	
Preset value	
Firmware version	FIR-v1614
Change history	

---

### Value description

Subindex	00 <sub>h</sub>
Name	Number Of Entries
Data type	UNSIGNED8
Access	read / write
PDO mapping	no
Allowed values	
Preset value	00 <sub>h</sub>

---

Subindex	01 <sub>h</sub>
Name	1st Object To Be Mapped

Data type	UNSIGNED32
Access	read / write
PDO mapping	no
Allowed values	
Preset value	00000000 <sub>h</sub>

---

Subindex	02 <sub>h</sub>
Name	2nd Object To Be Mapped
Data type	UNSIGNED32
Access	read / write
PDO mapping	no
Allowed values	
Preset value	00000000 <sub>h</sub>

---

Subindex	03 <sub>h</sub>
Name	3rd Object To Be Mapped
Data type	UNSIGNED32
Access	read / write
PDO mapping	no
Allowed values	
Preset value	00000000 <sub>h</sub>

---

Subindex	04 <sub>h</sub>
Name	4th Object To Be Mapped
Data type	UNSIGNED32
Access	read / write
PDO mapping	no
Allowed values	
Preset value	00000000 <sub>h</sub>

---

Subindex	05 <sub>h</sub>
Name	5th Object To Be Mapped
Data type	UNSIGNED32
Access	read / write
PDO mapping	no
Allowed values	
Preset value	00000000 <sub>h</sub>

---

Subindex	06 <sub>h</sub>
Name	6th Object To Be Mapped
Data type	UNSIGNED32
Access	read / write
PDO mapping	no

Allowed values

Preset value 00000000<sub>h</sub>

---

Subindex	07 <sub>h</sub>
Name	7th Object To Be Mapped
Data type	UNSIGNED32
Access	read / write
PDO mapping	no
Allowed values	
Preset value	00000000 <sub>h</sub>

---



---

Subindex	08 <sub>h</sub>
Name	8th Object To Be Mapped
Data type	UNSIGNED32
Access	read / write
PDO mapping	no
Allowed values	
Preset value	00000000 <sub>h</sub>

---

## 1605h Receive PDO 6 Mapping Parameter

### Function

This object contains the mapping parameters for PDOs that the controller can receive (RX-PDO 6). The PDO was previously configured via [1405h Receive PDO 6 Communication Parameter](#). See chapter [Process Data Object \(PDO\)](#).

### Object description

---

Index	1605 <sub>h</sub>
Object name	Receive PDO 6 Mapping Parameter
Object Code	RECORD
Data type	PDO_MAPPING
Savable	yes, category: communication
Access	read / write
PDO mapping	no
Allowed values	
Preset value	
Firmware version	FIR-v1614
Change history	

---

### Value description

---

Subindex	00 <sub>h</sub>
Name	Number Of Entries
Data type	UNSIGNED8

---

Access	read / write
PDO mapping	no
Allowed values	
Preset value	00 <sub>h</sub>

---

Subindex	01 <sub>h</sub>
Name	1st Object To Be Mapped
Data type	UNSIGNED32
Access	read / write
PDO mapping	no
Allowed values	
Preset value	00000000 <sub>h</sub>

---

Subindex	02 <sub>h</sub>
Name	2nd Object To Be Mapped
Data type	UNSIGNED32
Access	read / write
PDO mapping	no
Allowed values	
Preset value	00000000 <sub>h</sub>

---

Subindex	03 <sub>h</sub>
Name	3rd Object To Be Mapped
Data type	UNSIGNED32
Access	read / write
PDO mapping	no
Allowed values	
Preset value	00000000 <sub>h</sub>

---

Subindex	04 <sub>h</sub>
Name	4th Object To Be Mapped
Data type	UNSIGNED32
Access	read / write
PDO mapping	no
Allowed values	
Preset value	00000000 <sub>h</sub>

---

Subindex	05 <sub>h</sub>
Name	5th Object To Be Mapped
Data type	UNSIGNED32
Access	read / write
PDO mapping	no
Allowed values	

Preset value	00000000 <sub>h</sub>
--------------	-----------------------

Subindex	06 <sub>h</sub>
Name	6th Object To Be Mapped
Data type	UNSIGNED32
Access	read / write
PDO mapping	no
Allowed values	
Preset value	00000000 <sub>h</sub>

Subindex	07 <sub>h</sub>
Name	7th Object To Be Mapped
Data type	UNSIGNED32
Access	read / write
PDO mapping	no
Allowed values	
Preset value	00000000 <sub>h</sub>

Subindex	08 <sub>h</sub>
Name	8th Object To Be Mapped
Data type	UNSIGNED32
Access	read / write
PDO mapping	no
Allowed values	
Preset value	00000000 <sub>h</sub>

## 1606h Receive PDO 7 Mapping Parameter

### Function

This object contains the mapping parameters for PDOs that the controller can receive (RX-PDO 7). The PDO was previously configured via [1406h Receive PDO 7 Communication Parameter](#). See chapter [Process Data Object \(PDO\)](#).

### Object description

Index	1606 <sub>h</sub>
Object name	Receive PDO 7 Mapping Parameter
Object Code	RECORD
Data type	PDO_MAPPING
Savable	yes, category: communication
Access	read / write
PDO mapping	no
Allowed values	
Preset value	
Firmware version	FIR-v1614

## Change history

**Value description**

---

Subindex	00 <sub>h</sub>
Name	Number Of Entries
Data type	UNSIGNED8
Access	read / write
PDO mapping	no
Allowed values	
Preset value	00 <sub>h</sub>

---



---

Subindex	01 <sub>h</sub>
Name	1st Object To Be Mapped
Data type	UNSIGNED32
Access	read / write
PDO mapping	no
Allowed values	
Preset value	00000000 <sub>h</sub>

---



---

Subindex	02 <sub>h</sub>
Name	2nd Object To Be Mapped
Data type	UNSIGNED32
Access	read / write
PDO mapping	no
Allowed values	
Preset value	00000000 <sub>h</sub>

---



---

Subindex	03 <sub>h</sub>
Name	3rd Object To Be Mapped
Data type	UNSIGNED32
Access	read / write
PDO mapping	no
Allowed values	
Preset value	00000000 <sub>h</sub>

---



---

Subindex	04 <sub>h</sub>
Name	4th Object To Be Mapped
Data type	UNSIGNED32
Access	read / write
PDO mapping	no
Allowed values	
Preset value	00000000 <sub>h</sub>

---



Subindex	05 <sub>h</sub>
Name	5th Object To Be Mapped
Data type	UNSIGNED32
Access	read / write
PDO mapping	no
Allowed values	
Preset value	00000000 <sub>h</sub>

Subindex	06 <sub>h</sub>
Name	6th Object To Be Mapped
Data type	UNSIGNED32
Access	read / write
PDO mapping	no
Allowed values	
Preset value	00000000 <sub>h</sub>

Subindex	07 <sub>h</sub>
Name	7th Object To Be Mapped
Data type	UNSIGNED32
Access	read / write
PDO mapping	no
Allowed values	
Preset value	00000000 <sub>h</sub>

Subindex	08 <sub>h</sub>
Name	8th Object To Be Mapped
Data type	UNSIGNED32
Access	read / write
PDO mapping	no
Allowed values	
Preset value	00000000 <sub>h</sub>

## 1607h Receive PDO 8 Mapping Parameter

### Function

This object contains the mapping parameters for PDOs that the controller can receive (RX-PDO 8). The PDO was previously configured via [1407h Receive PDO 8 Communication Parameter](#). See chapter [Process Data Object \(PDO\)](#).

### Object description

Index	1607 <sub>h</sub>
Object name	Receive PDO 8 Mapping Parameter
Object Code	RECORD
Data type	PDO_MAPPING

Savable	yes, category: communication
Access	read / write
PDO mapping	no
Allowed values	
Preset value	
Firmware version	FIR-v1614
Change history	

---

## Value description

---

Subindex	00 <sub>h</sub>
Name	Number Of Entries
Data type	UNSIGNED8
Access	read / write
PDO mapping	no
Allowed values	
Preset value	00 <sub>h</sub>

---



---

Subindex	01 <sub>h</sub>
Name	1st Object To Be Mapped
Data type	UNSIGNED32
Access	read / write
PDO mapping	no
Allowed values	
Preset value	00000000 <sub>h</sub>

---



---

Subindex	02 <sub>h</sub>
Name	2nd Object To Be Mapped
Data type	UNSIGNED32
Access	read / write
PDO mapping	no
Allowed values	
Preset value	00000000 <sub>h</sub>

---



---

Subindex	03 <sub>h</sub>
Name	3rd Object To Be Mapped
Data type	UNSIGNED32
Access	read / write
PDO mapping	no
Allowed values	
Preset value	00000000 <sub>h</sub>

---



---

Subindex	04 <sub>h</sub>
----------	-----------------

---

Name	4th Object To Be Mapped
Data type	UNSIGNED32
Access	read / write
PDO mapping	no
Allowed values	
Preset value	00000000 <sub>h</sub>

Subindex	05 <sub>h</sub>
Name	5th Object To Be Mapped
Data type	UNSIGNED32
Access	read / write
PDO mapping	no
Allowed values	
Preset value	00000000 <sub>h</sub>

Subindex	06 <sub>h</sub>
Name	6th Object To Be Mapped
Data type	UNSIGNED32
Access	read / write
PDO mapping	no
Allowed values	
Preset value	00000000 <sub>h</sub>

Subindex	07 <sub>h</sub>
Name	7th Object To Be Mapped
Data type	UNSIGNED32
Access	read / write
PDO mapping	no
Allowed values	
Preset value	00000000 <sub>h</sub>

Subindex	08 <sub>h</sub>
Name	8th Object To Be Mapped
Data type	UNSIGNED32
Access	read / write
PDO mapping	no
Allowed values	
Preset value	00000000 <sub>h</sub>

## 1800h Transmit PDO 1 Communication Parameter

### Function

Contains the communication parameters for the sending-side mapping (TX-PDO) 1. See chapter [Process Data Object \(PDO\)](#).

## Object description

Index	1800 <sub>h</sub>
Object name	Transmit PDO 1 Communication Parameter
Object Code	RECORD
Data type	PDO_COMMUNICATION_PARAMETER
Savable	yes, category: communication
Access	read only
PDO mapping	no
Allowed values	
Preset value	
Firmware version	FIR-v1426
Change history	Firmware version FIR-v1738-B501312: The number of entries was changed from 6 to 7.

## Value description

Subindex	00 <sub>h</sub>
Name	Number Of Entries
Data type	UNSIGNED8
Access	read only
PDO mapping	no
Allowed values	
Preset value	06 <sub>h</sub>

Subindex	01 <sub>h</sub>
Name	COB-ID
Data type	UNSIGNED32
Access	read / write
PDO mapping	no
Allowed values	
Preset value	00000000 <sub>h</sub>

Subindex	02 <sub>h</sub>
Name	Transmission Type
Data type	UNSIGNED8
Access	read / write
PDO mapping	no
Allowed values	
Preset value	FF <sub>h</sub>

Subindex	03 <sub>h</sub>
Name	Inhibit Time
Data type	UNSIGNED16

Access	read / write
PDO mapping	no
Allowed values	
Preset value	0064 <sub>h</sub>

---

Subindex	04 <sub>h</sub>
Name	Compatibility Entry
Data type	UNSIGNED8
Access	read / write
PDO mapping	no
Allowed values	
Preset value	00 <sub>h</sub>

---

Subindex	05 <sub>h</sub>
Name	Event Timer
Data type	UNSIGNED16
Access	read / write
PDO mapping	no
Allowed values	
Preset value	0000 <sub>h</sub>

---

Subindex	06 <sub>h</sub>
Name	SYNC Start Value
Data type	UNSIGNED8
Access	read / write
PDO mapping	no
Allowed values	
Preset value	00 <sub>h</sub>

---

## Description

Subindex 01<sub>h</sub> (COB-ID): The COB-ID is stored here.

Subindex 02<sub>h</sub> (transmission type): A number is stored in this subindex that defines the time at which the received data become valid.

Subindex 3 (inhibit time): This can be used to set a time in 100 μs steps that must elapse after the sending of a PDO before the PDO is sent another time. This time only applies for asynchronous PDOs.

Subindex 4 (compatibility entry): This subindex has no function and exists only for compatibility reasons.

Subindex 5 (event timer): This time (in ms) can be used to trigger an *Event* which handles the copying of the data and the sending of the PDO.

Subindex 6 (sync start value): Here, the start value of the *Sync Counter* is entered beginning with which the *slave* is to initially respond to the sync and send the PDO. Thereafter, sending of the PDO is only dependent on *Transmission Type* (subindex 02<sub>h</sub>). Not globally activated until a value greater than 1 is set in 1019h Synchronous Counter Overflow Value.

For details, see chapter on configuring the Tx-PDO mapping.

## 1801h Transmit PDO 2 Communication Parameter

### Function

Contains the communication parameters for the sending-side mapping (TX-PDO) 2. See chapter [Process Data Object \(PDO\)](#).

### Object description

Index	1801 <sub>h</sub>
Object name	Transmit PDO 2 Communication Parameter
Object Code	RECORD
Data type	PDO_COMMUNICATION_PARAMETER
Savable	yes, category: communication
Access	read only
PDO mapping	no
Allowed values	
Preset value	
Firmware version	FIR-v1426
Change history	Firmware version FIR-v1738-B501312: The number of entries was changed from 6 to 7.

### Value description

Subindex	00 <sub>h</sub>
Name	Number Of Entries
Data type	UNSIGNED8
Access	read only
PDO mapping	no
Allowed values	
Preset value	06 <sub>h</sub>

Subindex	01 <sub>h</sub>
Name	COB-ID
Data type	UNSIGNED32
Access	read / write
PDO mapping	no
Allowed values	
Preset value	00000000 <sub>h</sub>

Subindex	02 <sub>h</sub>
Name	Transmission Type
Data type	UNSIGNED8
Access	read / write
PDO mapping	no
Allowed values	

Preset value	FF <sub>h</sub>
Subindex	03 <sub>h</sub>
Name	Inhibit Time
Data type	UNSIGNED16
Access	read / write
PDO mapping	no
Allowed values	
Preset value	0064 <sub>h</sub>
Subindex	04 <sub>h</sub>
Name	Compatibility Entry
Data type	UNSIGNED8
Access	read / write
PDO mapping	no
Allowed values	
Preset value	00 <sub>h</sub>
Subindex	05 <sub>h</sub>
Name	Event Timer
Data type	UNSIGNED16
Access	read / write
PDO mapping	no
Allowed values	
Preset value	0000 <sub>h</sub>
Subindex	06 <sub>h</sub>
Name	SYNC Start Value
Data type	UNSIGNED8
Access	read / write
PDO mapping	no
Allowed values	
Preset value	00 <sub>h</sub>

## Description

Subindex 01<sub>h</sub> (COB-ID): The COB-ID is stored here.

Subindex 02<sub>h</sub> (transmission type): A number is stored in this subindex that defines the time at which the received data become valid.

Subindex 3 (inhibit time): This can be used to set a time in 100 µs steps that must elapse after the sending of a PDO before the PDO is sent another time. This time only applies for asynchronous PDOs.

Subindex 4 (compatibility entry): This subindex has no function and exists only for compatibility reasons.

Subindex 5 (event timer): This time (in ms) can be used to trigger an *Event* which handles the copying of the data and the sending of the PDO.

Subindex 6 (sync start value): Here, the start value of the *Sync Counter* is entered beginning with which the *slave* is to initially respond to the sync and send the PDO. Thereafter, sending of the PDO is only dependent on *Transmission Type* (subindex 02<sub>h</sub>). Not globally activated until a value greater than 1 is set in 1019h Synchronous Counter Overflow Value.

For details, see chapter on configuring the Tx-PDO mapping.

## 1802h Transmit PDO 3 Communication Parameter

### Function

Contains the communication parameters for the sending-side mapping (TX-PDO) 3. See chapter Process Data Object (PDO).

### Object description

Index	1802 <sub>h</sub>
Object name	Transmit PDO 3 Communication Parameter
Object Code	RECORD
Data type	PDO_COMMUNICATION_PARAMETER
Savable	yes, category: communication
Access	read only
PDO mapping	no
Allowed values	
Preset value	
Firmware version	FIR-v1426
Change history	Firmware version FIR-v1738-B501312: The number of entries was changed from 6 to 7.

### Value description

Subindex	00 <sub>h</sub>
Name	Number Of Entries
Data type	UNSIGNED8
Access	read only
PDO mapping	no
Allowed values	
Preset value	06 <sub>h</sub>

Subindex	01 <sub>h</sub>
Name	COB-ID
Data type	UNSIGNED32
Access	read / write
PDO mapping	no
Allowed values	
Preset value	00000000 <sub>h</sub>

Subindex	02 <sub>h</sub>
----------	-----------------



Name	Transmission Type
Data type	UNSIGNED8
Access	read / write
PDO mapping	no
Allowed values	
Preset value	FF <sub>h</sub>

Subindex	03 <sub>h</sub>
Name	Inhibit Time
Data type	UNSIGNED16
Access	read / write
PDO mapping	no
Allowed values	
Preset value	0064 <sub>h</sub>

Subindex	04 <sub>h</sub>
Name	Compatibility Entry
Data type	UNSIGNED8
Access	read / write
PDO mapping	no
Allowed values	
Preset value	00 <sub>h</sub>

Subindex	05 <sub>h</sub>
Name	Event Timer
Data type	UNSIGNED16
Access	read / write
PDO mapping	no
Allowed values	
Preset value	0000 <sub>h</sub>

Subindex	06 <sub>h</sub>
Name	SYNC Start Value
Data type	UNSIGNED8
Access	read / write
PDO mapping	no
Allowed values	
Preset value	00 <sub>h</sub>

## Description

Subindex 01<sub>h</sub> (COB-ID): The COB-ID is stored here.

Subindex 02<sub>h</sub> (transmission type): A number is stored in this subindex that defines the time at which the received data become valid.

Subindex 3 (inhibit time): This can be used to set a time in 100  $\mu$ s steps that must elapse after the sending of a PDO before the PDO is sent another time. This time only applies for asynchronous PDOs.

Subindex 4 (compatibility entry): This subindex has no function and exists only for compatibility reasons.

Subindex 5 (event timer): This time (in ms) can be used to trigger an *Event* which handles the copying of the data and the sending of the PDO.

Subindex 6 (sync start value): Here, the start value of the *Sync Counter* is entered beginning with which the *slave* is to initially respond to the sync and send the PDO. Thereafter, sending of the PDO is only dependent on *Transmission Type* (subindex 02<sub>h</sub>). Not globally activated until a value greater than 1 is set in 1019h Synchronous Counter Overflow Value.

For details, see chapter on configuring the Tx-PDO mapping.

## 1803h Transmit PDO 4 Communication Parameter

### Function

Contains the communication parameters for the sending-side mapping (TX-PDO) 4. See chapter Process Data Object (PDO).

### Object description

Index	1803 <sub>h</sub>
Object name	Transmit PDO 4 Communication Parameter
Object Code	RECORD
Data type	PDO_COMMUNICATION_PARAMETER
Savable	yes, category: communication
Access	read only
PDO mapping	no
Allowed values	
Preset value	
Firmware version	FIR-v1426
Change history	Firmware version FIR-v1738-B501312: The number of entries was changed from 6 to 7.

### Value description

Subindex	00 <sub>h</sub>
Name	Number Of Entries
Data type	UNSIGNED8
Access	read only
PDO mapping	no
Allowed values	
Preset value	06 <sub>h</sub>

Subindex	01 <sub>h</sub>
Name	COB-ID
Data type	UNSIGNED32
Access	read / write

PDO mapping	no
Allowed values	
Preset value	00000000 <sub>h</sub>
<hr/>	
Subindex	02 <sub>h</sub>
Name	Transmission Type
Data type	UNSIGNED8
Access	read / write
PDO mapping	no
Allowed values	
Preset value	FF <sub>h</sub>
<hr/>	
Subindex	03 <sub>h</sub>
Name	Inhibit Time
Data type	UNSIGNED16
Access	read / write
PDO mapping	no
Allowed values	
Preset value	0064 <sub>h</sub>
<hr/>	
Subindex	04 <sub>h</sub>
Name	Compatibility Entry
Data type	UNSIGNED8
Access	read / write
PDO mapping	no
Allowed values	
Preset value	00 <sub>h</sub>
<hr/>	
Subindex	05 <sub>h</sub>
Name	Event Timer
Data type	UNSIGNED16
Access	read / write
PDO mapping	no
Allowed values	
Preset value	0000 <sub>h</sub>
<hr/>	
Subindex	06 <sub>h</sub>
Name	SYNC Start Value
Data type	UNSIGNED8
Access	read / write
PDO mapping	no
Allowed values	
Preset value	00 <sub>h</sub>
<hr/>	

## Description

Subindex 01<sub>h</sub> (COB-ID): The COB-ID is stored here.

Subindex 02<sub>h</sub> (transmission type): A number is stored in this subindex that defines the time at which the received data become valid.

Subindex 3 (inhibit time): This can be used to set a time in 100 µs steps that must elapse after the sending of a PDO before the PDO is sent another time. This time only applies for asynchronous PDOs.

Subindex 4 (compatibility entry): This subindex has no function and exists only for compatibility reasons.

Subindex 5 (event timer): This time (in ms) can be used to trigger an *Event* which handles the copying of the data and the sending of the PDO.

Subindex 6 (sync start value): Here, the start value of the *Sync Counter* is entered beginning with which the *slave* is to initially respond to the sync and send the PDO. Thereafter, sending of the PDO is only dependent on *Transmission Type* (subindex 02<sub>h</sub>). Not globally activated until a value greater than 1 is set in 1019h Synchronous Counter Overflow Value.

For details, see chapter on [configuring the Tx-PDO mapping](#).

## 1804h Transmit PDO 5 Communication Parameter

### Function

Contains the communication parameters for the sending-side mapping (TX-PDO) 5. See chapter [Process Data Object \(PDO\)](#).

### Object description

Index	1804 <sub>h</sub>
Object name	Transmit PDO 5 Communication Parameter
Object Code	RECORD
Data type	PDO_COMMUNICATION_PARAMETER
Savable	yes, category: communication
Access	read only
PDO mapping	no
Allowed values	
Preset value	
Firmware version	FIR-v1614
Change history	Firmware version FIR-v1738-B501312: The number of entries was changed from 6 to 7.

### Value description

Subindex	00 <sub>h</sub>
Name	Number Of Entries
Data type	UNSIGNED8
Access	read only
PDO mapping	no
Allowed values	
Preset value	06 <sub>h</sub>

Subindex	01 <sub>h</sub>
Name	COB-ID
Data type	UNSIGNED32
Access	read / write
PDO mapping	no
Allowed values	
Preset value	C0000000 <sub>h</sub>
Subindex	02 <sub>h</sub>
Name	Transmission Type
Data type	UNSIGNED8
Access	read / write
PDO mapping	no
Allowed values	
Preset value	FF <sub>h</sub>
Subindex	03 <sub>h</sub>
Name	Inhibit Time
Data type	UNSIGNED16
Access	read / write
PDO mapping	no
Allowed values	
Preset value	0064 <sub>h</sub>
Subindex	04 <sub>h</sub>
Name	Compatibility Entry
Data type	UNSIGNED8
Access	read / write
PDO mapping	no
Allowed values	
Preset value	00 <sub>h</sub>
Subindex	05 <sub>h</sub>
Name	Event Timer
Data type	UNSIGNED16
Access	read / write
PDO mapping	no
Allowed values	
Preset value	0000 <sub>h</sub>
Subindex	06 <sub>h</sub>
Name	SYNC Start Value
Data type	UNSIGNED8

Access	read / write
PDO mapping	no
Allowed values	
Preset value	00 <sub>h</sub>

## Description

Subindex 01<sub>h</sub> (COB-ID): The COB-ID is stored here.

Subindex 02<sub>h</sub> (transmission type): A number is stored in this subindex that defines the time at which the received data become valid.

Subindex 3 (inhibit time): This can be used to set a time in 100 µs steps that must elapse after the sending of a PDO before the PDO is sent another time. This time only applies for asynchronous PDOs.

Subindex 4 (compatibility entry): This subindex has no function and exists only for compatibility reasons.

Subindex 5 (event timer): This time (in ms) can be used to trigger an *Event* which handles the copying of the data and the sending of the PDO.

Subindex 6 (sync start value): Here, the start value of the *Sync Counter* is entered beginning with which the *slave* is to initially respond to the sync and send the PDO. Thereafter, sending of the PDO is only dependent on *Transmission Type* (subindex 02<sub>h</sub>). Not globally activated until a value greater than 1 is set in 1019h Synchronous Counter Overflow Value.

For details, see chapter on [configuring the Tx-PDO mapping](#).

## 1805h Transmit PDO 6 Communication Parameter

### Function

Contains the communication parameters for the sending-side mapping (TX-PDO) 6. See chapter [Process Data Object \(PDO\)](#).

### Object description

Index	1805 <sub>h</sub>
Object name	Transmit PDO 6 Communication Parameter
Object Code	RECORD
Data type	PDO_COMMUNICATION_PARAMETER
Savable	yes, category: communication
Access	read only
PDO mapping	no
Allowed values	
Preset value	
Firmware version	FIR-v1614
Change history	Firmware version FIR-v1738-B501312: The number of entries was changed from 6 to 7.

### Value description

Subindex	00 <sub>h</sub>
Name	Number Of Entries
Data type	UNSIGNED8

Access	read only
PDO mapping	no
Allowed values	
Preset value	06 <sub>h</sub>

---

Subindex	01 <sub>h</sub>
Name	COB-ID
Data type	UNSIGNED32
Access	read / write
PDO mapping	no
Allowed values	
Preset value	C0000000 <sub>h</sub>

---

Subindex	02 <sub>h</sub>
Name	Transmission Type
Data type	UNSIGNED8
Access	read / write
PDO mapping	no
Allowed values	
Preset value	FF <sub>h</sub>

---

Subindex	03 <sub>h</sub>
Name	Inhibit Time
Data type	UNSIGNED16
Access	read / write
PDO mapping	no
Allowed values	
Preset value	0064 <sub>h</sub>

---

Subindex	04 <sub>h</sub>
Name	Compatibility Entry
Data type	UNSIGNED8
Access	read / write
PDO mapping	no
Allowed values	
Preset value	00 <sub>h</sub>

---

Subindex	05 <sub>h</sub>
Name	Event Timer
Data type	UNSIGNED16
Access	read / write
PDO mapping	no
Allowed values	

Preset value	0000 <sub>h</sub>
--------------	-------------------

Subindex	06 <sub>h</sub>
Name	SYNC Start Value
Data type	UNSIGNED8
Access	read / write
PDO mapping	no
Allowed values	
Preset value	00 <sub>h</sub>

## Description

Subindex 01<sub>h</sub> (COB-ID): The COB-ID is stored here.

Subindex 02<sub>h</sub> (transmission type): A number is stored in this subindex that defines the time at which the received data become valid.

Subindex 3 (inhibit time): This can be used to set a time in 100 µs steps that must elapse after the sending of a PDO before the PDO is sent another time. This time only applies for asynchronous PDOs.

Subindex 4 (compatibility entry): This subindex has no function and exists only for compatibility reasons.

Subindex 5 (event timer): This time (in ms) can be used to trigger an *Event* which handles the copying of the data and the sending of the PDO.

Subindex 6 (sync start value): Here, the start value of the *Sync Counter* is entered beginning with which the *slave* is to initially respond to the sync and send the PDO. Thereafter, sending of the PDO is only dependent on *Transmission Type* (subindex 02<sub>h</sub>). Not globally activated until a value greater than 1 is set in 1019h Synchronous Counter Overflow Value.

For details, see chapter on [configuring the Tx-PDO mapping](#).

## 1806h Transmit PDO 7 Communication Parameter

### Function

Contains the communication parameters for the sending-side mapping (TX-PDO) 7. See chapter [Process Data Object \(PDO\)](#).

### Object description

Index	1806 <sub>h</sub>
Object name	Transmit PDO 7 Communication Parameter
Object Code	RECORD
Data type	PDO_COMMUNICATION_PARAMETER
Savable	yes, category: communication
Access	read only
PDO mapping	no
Allowed values	
Preset value	
Firmware version	FIR-v1614
Change history	Firmware version FIR-v1738-B501312: The number of entries was changed from 6 to 7.



## Value description

Subindex	00 <sub>h</sub>
Name	Number Of Entries
Data type	UNSIGNED8
Access	read only
PDO mapping	no
Allowed values	
Preset value	06 <sub>h</sub>

Subindex	01 <sub>h</sub>
Name	COB-ID
Data type	UNSIGNED32
Access	read / write
PDO mapping	no
Allowed values	
Preset value	C0000000 <sub>h</sub>

Subindex	02 <sub>h</sub>
Name	Transmission Type
Data type	UNSIGNED8
Access	read / write
PDO mapping	no
Allowed values	
Preset value	FF <sub>h</sub>

Subindex	03 <sub>h</sub>
Name	Inhibit Time
Data type	UNSIGNED16
Access	read / write
PDO mapping	no
Allowed values	
Preset value	0064 <sub>h</sub>

Subindex	04 <sub>h</sub>
Name	Compatibility Entry
Data type	UNSIGNED8
Access	read / write
PDO mapping	no
Allowed values	
Preset value	00 <sub>h</sub>

Subindex	05 <sub>h</sub>
----------	-----------------

Name	Event Timer
Data type	UNSIGNED16
Access	read / write
PDO mapping	no
Allowed values	
Preset value	0000 <sub>h</sub>

Subindex	06 <sub>h</sub>
Name	SYNC Start Value
Data type	UNSIGNED8
Access	read / write
PDO mapping	no
Allowed values	
Preset value	00 <sub>h</sub>

## Description

Subindex 01<sub>h</sub> (COB-ID): The COB-ID is stored here.

Subindex 02<sub>h</sub> (transmission type): A number is stored in this subindex that defines the time at which the received data become valid.

Subindex 3 (inhibit time): This can be used to set a time in 100 µs steps that must elapse after the sending of a PDO before the PDO is sent another time. This time only applies for asynchronous PDOs.

Subindex 4 (compatibility entry): This subindex has no function and exists only for compatibility reasons.

Subindex 5 (event timer): This time (in ms) can be used to trigger an *Event* which handles the copying of the data and the sending of the PDO.

Subindex 6 (sync start value): Here, the start value of the *Sync Counter* is entered beginning with which the *slave* is to initially respond to the sync and send the PDO. Thereafter, sending of the PDO is only dependent on *Transmission Type* (subindex 02<sub>h</sub>). Not globally activated until a value greater than 1 is set in 1019<sub>h</sub> Synchronous Counter Overflow Value.

For details, see chapter on [configuring the Tx-PDO mapping](#).

## 1807h Transmit PDO 8 Communication Parameter

### Function

Contains the communication parameters for the sending-side mapping (TX-PDO) 8. See chapter [Process Data Object \(PDO\)](#).

### Object description

Index	1807 <sub>h</sub>
Object name	Transmit PDO 8 Communication Parameter
Object Code	RECORD
Data type	PDO_COMMUNICATION_PARAMETER
Savable	yes, category: communication
Access	read only
PDO mapping	no
Allowed values	

Preset value	
Firmware version	FIR-v1614
Change history	Firmware version FIR-v1738-B501312: The number of entries was changed from 6 to 7.

---

## Value description

Subindex	00 <sub>h</sub>
Name	Number Of Entries
Data type	UNSIGNED8
Access	read only
PDO mapping	no
Allowed values	
Preset value	06 <sub>h</sub>

---

Subindex	01 <sub>h</sub>
Name	COB-ID
Data type	UNSIGNED32
Access	read / write
PDO mapping	no
Allowed values	
Preset value	C0000000 <sub>h</sub>

---

Subindex	02 <sub>h</sub>
Name	Transmission Type
Data type	UNSIGNED8
Access	read / write
PDO mapping	no
Allowed values	
Preset value	FF <sub>h</sub>

---

Subindex	03 <sub>h</sub>
Name	Inhibit Time
Data type	UNSIGNED16
Access	read / write
PDO mapping	no
Allowed values	
Preset value	0064 <sub>h</sub>

---

Subindex	04 <sub>h</sub>
Name	Compatibility Entry
Data type	UNSIGNED8
Access	read / write

PDO mapping	no
Allowed values	
Preset value	00 <sub>h</sub>

---

Subindex	05 <sub>h</sub>
Name	Event Timer
Data type	UNSIGNED16
Access	read / write
PDO mapping	no
Allowed values	
Preset value	0000 <sub>h</sub>

---

Subindex	06 <sub>h</sub>
Name	SYNC Start Value
Data type	UNSIGNED8
Access	read / write
PDO mapping	no
Allowed values	
Preset value	00 <sub>h</sub>

---

## Description

Subindex 01<sub>h</sub> (COB-ID): The COB-ID is stored here.

Subindex 02<sub>h</sub> (transmission type): A number is stored in this subindex that defines the time at which the received data become valid.

Subindex 3 (inhibit time): This can be used to set a time in 100  $\mu$ s steps that must elapse after the sending of a PDO before the PDO is sent another time. This time only applies for asynchronous PDOs.

Subindex 4 (compatibility entry): This subindex has no function and exists only for compatibility reasons.

Subindex 5 (event timer): This time (in ms) can be used to trigger an *Event* which handles the copying of the data and the sending of the PDO.

Subindex 6 (sync start value): Here, the start value of the *Sync Counter* is entered beginning with which the *slave* is to initially respond to the sync and send the PDO. Thereafter, sending of the PDO is only dependent on *Transmission Type* (subindex 02<sub>h</sub>). Not globally activated until a value greater than 1 is set in 1019h Synchronous Counter Overflow Value.

For details, see chapter on configuring the Tx-PDO mapping.

## 1A00h Transmit PDO 1 Mapping Parameter

### Function

This object contains the mapping parameters for PDOs that the controller can send (TX-PDO 1). The PDO was previously configured via 1800h Transmit PDO 1 Communication Parameter. See chapter Process Data Object (PDO).

### Object description

Index	1A00 <sub>h</sub>
Object name	Transmit PDO 1 Mapping Parameter

Object Code	RECORD
Data type	PDO_MAPPING
Savable	yes, category: communication
Firmware version	FIR-v1426
Change history	<p>Firmware version FIR-v1426: "Heading" entry changed from "1A00h Drive Status" to "1A00h Transmit PDO 1 Mapping Parameter".</p> <p>Firmware version FIR-v1426: "Object Name" entry changed from "Drive Status" to "Transmit PDO 1 Mapping Parameter".</p>

## Value description

Subindex	00 <sub>h</sub>
Name	Number Of Entries
Data type	UNSIGNED8
Access	read / write
PDO mapping	no
Allowed values	
Preset value	02 <sub>h</sub>

Subindex	01 <sub>h</sub>
Name	1st Object To Be Mapped
Data type	UNSIGNED32
Access	read / write
PDO mapping	no
Allowed values	
Preset value	60410010 <sub>h</sub>

Subindex	02 <sub>h</sub>
Name	2nd Object To Be Mapped
Data type	UNSIGNED32
Access	read / write
PDO mapping	no
Allowed values	
Preset value	60610008 <sub>h</sub>

Subindex	03 <sub>h</sub>
Name	3rd Object To Be Mapped
Data type	UNSIGNED32
Access	read / write
PDO mapping	no
Allowed values	
Preset value	00000000 <sub>h</sub>

---

Subindex	04 <sub>h</sub>
Name	4th Object To Be Mapped
Data type	UNSIGNED32
Access	read / write
PDO mapping	no
Allowed values	
Preset value	00000000 <sub>h</sub>

---



---

Subindex	05 <sub>h</sub>
Name	5th Object To Be Mapped
Data type	UNSIGNED32
Access	read / write
PDO mapping	no
Allowed values	
Preset value	00000000 <sub>h</sub>

---



---

Subindex	06 <sub>h</sub>
Name	6th Object To Be Mapped
Data type	UNSIGNED32
Access	read / write
PDO mapping	no
Allowed values	
Preset value	00000000 <sub>h</sub>

---



---

Subindex	07 <sub>h</sub>
Name	7th Object To Be Mapped
Data type	UNSIGNED32
Access	read / write
PDO mapping	no
Allowed values	
Preset value	00000000 <sub>h</sub>

---



---

Subindex	08 <sub>h</sub>
Name	8th Object To Be Mapped
Data type	UNSIGNED32
Access	read / write
PDO mapping	no
Allowed values	
Preset value	00000000 <sub>h</sub>

---

## Description

Each subindex (1–8) describes a different mapped object.

A mapping entry consists of four bytes, which are structured according to the following graphic.

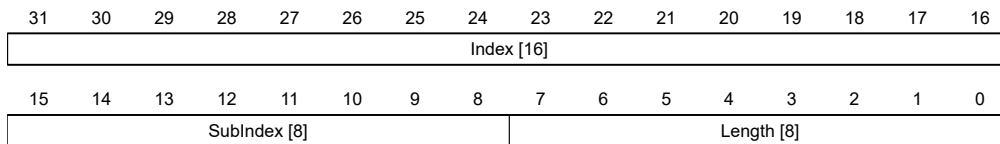
**Index [16]**

This contains the index of the object to be mapped.

**Subindex [8]**

This contains the subindex of the object to be mapped.

**Length [8]**

This contains the length of the object to be mapped in units of bits.

## 1A01h Transmit PDO 2 Mapping Parameter

### Function

This object contains the mapping parameters for PDOs that the controller can send (TX-PDO 2). The PDO was previously configured via [1801h Transmit PDO 2 Communication Parameter](#). See chapter [Process Data Object \(PDO\)](#).

### Object description

Index	1A01 <sub>h</sub>
Object name	Transmit PDO 2 Mapping Parameter
Object Code	RECORD
Data type	PDO_MAPPING
Savable	yes, category: communication
Firmware version	FIR-v1426
Change history	<p>Firmware version FIR-v1426: "Heading" entry changed from "1A01h Positioning Status" to "1A01h Transmit PDO 2 Mapping Parameter".</p> <p>Firmware version FIR-v1426: "Object Name" entry changed from "Positioning Status" to "Transmit PDO 2 Mapping Parameter".</p>

### Value description

Subindex	00 <sub>h</sub>
Name	Number Of Entries
Data type	UNSIGNED8
Access	read / write
PDO mapping	no
Allowed values	
Preset value	01 <sub>h</sub>

Subindex	01 <sub>h</sub>
Name	1st Object To Be Mapped
Data type	UNSIGNED32

Access	read / write
PDO mapping	no
Allowed values	
Preset value	60640020 <sub>h</sub>

---

Subindex	02 <sub>h</sub>
Name	2nd Object To Be Mapped
Data type	UNSIGNED32
Access	read / write
PDO mapping	no
Allowed values	
Preset value	00000000 <sub>h</sub>

---

Subindex	03 <sub>h</sub>
Name	3rd Object To Be Mapped
Data type	UNSIGNED32
Access	read / write
PDO mapping	no
Allowed values	
Preset value	00000000 <sub>h</sub>

---

Subindex	04 <sub>h</sub>
Name	4th Object To Be Mapped
Data type	UNSIGNED32
Access	read / write
PDO mapping	no
Allowed values	
Preset value	00000000 <sub>h</sub>

---

Subindex	05 <sub>h</sub>
Name	5th Object To Be Mapped
Data type	UNSIGNED32
Access	read / write
PDO mapping	no
Allowed values	
Preset value	00000000 <sub>h</sub>

---

Subindex	06 <sub>h</sub>
Name	6th Object To Be Mapped
Data type	UNSIGNED32
Access	read / write
PDO mapping	no
Allowed values	



Preset value	00000000 <sub>h</sub>
Subindex	07 <sub>h</sub>
Name	7th Object To Be Mapped
Data type	UNSIGNED32
Access	read / write
PDO mapping	no
Allowed values	
Preset value	00000000 <sub>h</sub>
Subindex	08 <sub>h</sub>
Name	8th Object To Be Mapped
Data type	UNSIGNED32
Access	read / write
PDO mapping	no
Allowed values	
Preset value	00000000 <sub>h</sub>

### Description

Each subindex (1–8) describes a different mapped object.

A mapping entry consists of four bytes, which are structured according to the following graphic.

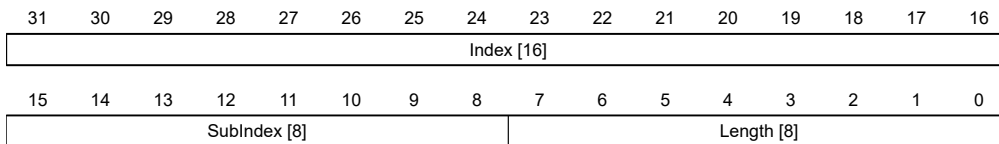

#### Index [16]

This contains the index of the object to be mapped.

#### Subindex [8]

This contains the subindex of the object to be mapped.

#### Length [8]

This contains the length of the object to be mapped in units of bits.

## 1A02h Transmit PDO 3 Mapping Parameter

### Function

This object contains the mapping parameters for PDOs that the controller can send (TX-PDO 3). The PDO was previously configured via [1802h Transmit PDO 3 Communication Parameter](#). See chapter [Process Data Object \(PDO\)](#).

### Object description

Index	1A02 <sub>h</sub>
Object name	Transmit PDO 3 Mapping Parameter

Object Code	RECORD
Data type	PDO_MAPPING
Savable	yes, category: communication
Firmware version	FIR-v1426
Change history	<p>Firmware version FIR-v1426: "Heading" entry changed from "1A02h Velocity Status" to "1A02h Transmit PDO 3 Mapping Parameter".</p> <p>Firmware version FIR-v1426: "Object Name" entry changed from "Velocity Status" to "Transmit PDO 3 Mapping Parameter".</p>

## Value description

Subindex	00 <sub>h</sub>
Name	Number Of Entries
Data type	UNSIGNED8
Access	read / write
PDO mapping	no
Allowed values	
Preset value	01 <sub>h</sub>

Subindex	01 <sub>h</sub>
Name	1st Object To Be Mapped
Data type	UNSIGNED32
Access	read / write
PDO mapping	no
Allowed values	
Preset value	60440010 <sub>h</sub>

Subindex	02 <sub>h</sub>
Name	2nd Object To Be Mapped
Data type	UNSIGNED32
Access	read / write
PDO mapping	no
Allowed values	
Preset value	00000000 <sub>h</sub>

Subindex	03 <sub>h</sub>
Name	3rd Object To Be Mapped
Data type	UNSIGNED32
Access	read / write
PDO mapping	no
Allowed values	
Preset value	00000000 <sub>h</sub>

Subindex	04 <sub>h</sub>
Name	4th Object To Be Mapped
Data type	UNSIGNED32
Access	read / write
PDO mapping	no
Allowed values	
Preset value	00000000 <sub>h</sub>
Subindex	05 <sub>h</sub>
Name	5th Object To Be Mapped
Data type	UNSIGNED32
Access	read / write
PDO mapping	no
Allowed values	
Preset value	00000000 <sub>h</sub>
Subindex	06 <sub>h</sub>
Name	6th Object To Be Mapped
Data type	UNSIGNED32
Access	read / write
PDO mapping	no
Allowed values	
Preset value	00000000 <sub>h</sub>
Subindex	07 <sub>h</sub>
Name	7th Object To Be Mapped
Data type	UNSIGNED32
Access	read / write
PDO mapping	no
Allowed values	
Preset value	00000000 <sub>h</sub>
Subindex	08 <sub>h</sub>
Name	8th Object To Be Mapped
Data type	UNSIGNED32
Access	read / write
PDO mapping	no
Allowed values	
Preset value	00000000 <sub>h</sub>

## Description

Each subindex (1–8) describes a different mapped object.

A mapping entry consists of four bytes, which are structured according to the following graphic.

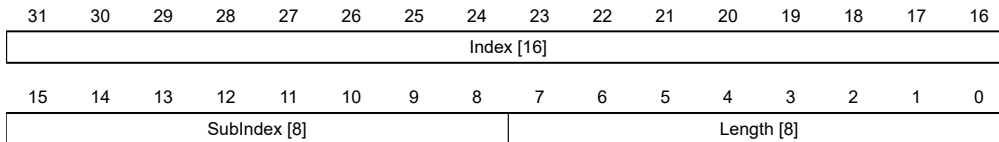
**Index [16]**

This contains the index of the object to be mapped.

**Subindex [8]**

This contains the subindex of the object to be mapped.

**Length [8]**

This contains the length of the object to be mapped in units of bits.

## 1A03h Transmit PDO 4 Mapping Parameter

### Function

This object contains the mapping parameters for PDOs that the controller can send (TX-PDO 4). The PDO was previously configured via [1803h Transmit PDO 4 Communication Parameter](#). See chapter [Process Data Object \(PDO\)](#).

### Object description

Index	1A03 <sub>h</sub>
Object name	Transmit PDO 4 Mapping Parameter
Object Code	RECORD
Data type	PDO_MAPPING
Savable	yes, category: communication
Firmware version	FIR-v1426
Change history	<p>Firmware version FIR-v1426: "Heading" entry changed from "1A03h Input Status" to "1A03h Transmit PDO 4 Mapping Parameter".</p> <p>Firmware version FIR-v1426: "Object Name" entry changed from "Input Status" to "Transmit PDO 4 Mapping Parameter".</p>

### Value description

Subindex	00 <sub>h</sub>
Name	Number Of Entries
Data type	UNSIGNED8
Access	read / write
PDO mapping	no
Allowed values	
Preset value	01 <sub>h</sub>

Subindex	01 <sub>h</sub>
Name	1st Object To Be Mapped
Data type	UNSIGNED32

Access	read / write
PDO mapping	no
Allowed values	
Preset value	60FD0020 <sub>h</sub>

---

Subindex	02 <sub>h</sub>
Name	2nd Object To Be Mapped
Data type	UNSIGNED32
Access	read / write
PDO mapping	no
Allowed values	
Preset value	00000000 <sub>h</sub>

---

Subindex	03 <sub>h</sub>
Name	3rd Object To Be Mapped
Data type	UNSIGNED32
Access	read / write
PDO mapping	no
Allowed values	
Preset value	00000000 <sub>h</sub>

---

Subindex	04 <sub>h</sub>
Name	4th Object To Be Mapped
Data type	UNSIGNED32
Access	read / write
PDO mapping	no
Allowed values	
Preset value	00000000 <sub>h</sub>

---

Subindex	05 <sub>h</sub>
Name	5th Object To Be Mapped
Data type	UNSIGNED32
Access	read / write
PDO mapping	no
Allowed values	
Preset value	00000000 <sub>h</sub>

---

Subindex	06 <sub>h</sub>
Name	6th Object To Be Mapped
Data type	UNSIGNED32
Access	read / write
PDO mapping	no
Allowed values	

Preset value	00000000 <sub>h</sub>
Subindex	07 <sub>h</sub>
Name	7th Object To Be Mapped
Data type	UNSIGNED32
Access	read / write
PDO mapping	no
Allowed values	
Preset value	00000000 <sub>h</sub>
Subindex	08 <sub>h</sub>
Name	8th Object To Be Mapped
Data type	UNSIGNED32
Access	read / write
PDO mapping	no
Allowed values	
Preset value	00000000 <sub>h</sub>

### Description

Each subindex (1–8) describes a different mapped object.

A mapping entry consists of four bytes, which are structured according to the following graphic.

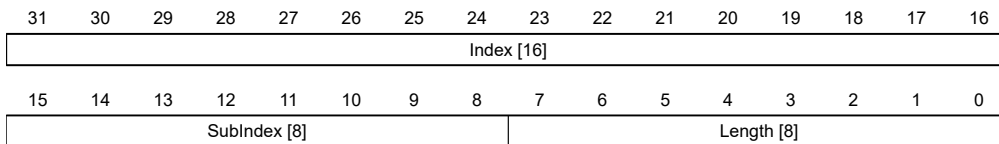

#### Index [16]

This contains the index of the object to be mapped.

#### Subindex [8]

This contains the subindex of the object to be mapped.

#### Length [8]

This contains the length of the object to be mapped in units of bits.

## 1A04h Transmit PDO 5 Mapping Parameter

### Function

This object contains the mapping parameters for PDOs that the controller can send (TX-PDO 5). The PDO was previously configured via [1804h Transmit PDO 5 Communication Parameter](#). See chapter [Process Data Object \(PDO\)](#).

### Object description

Index	1A04 <sub>h</sub>
Object name	Transmit PDO 5 Mapping Parameter

Object Code	RECORD
Data type	PDO_MAPPING
Savable	yes, category: communication
Access	read / write
PDO mapping	no
Allowed values	
Preset value	
Firmware version	FIR-v1614
Change history	

---

## Value description

---

Subindex	00 <sub>h</sub>
Name	Number Of Entries
Data type	UNSIGNED8
Access	read / write
PDO mapping	no
Allowed values	
Preset value	00 <sub>h</sub>

---



---

Subindex	01 <sub>h</sub>
Name	1st Object To Be Mapped
Data type	UNSIGNED32
Access	read / write
PDO mapping	no
Allowed values	
Preset value	00000000 <sub>h</sub>

---



---

Subindex	02 <sub>h</sub>
Name	2nd Object To Be Mapped
Data type	UNSIGNED32
Access	read / write
PDO mapping	no
Allowed values	
Preset value	00000000 <sub>h</sub>

---



---

Subindex	03 <sub>h</sub>
Name	3rd Object To Be Mapped
Data type	UNSIGNED32
Access	read / write
PDO mapping	no
Allowed values	
Preset value	00000000 <sub>h</sub>

---

Subindex	04 <sub>h</sub>
Name	4th Object To Be Mapped
Data type	UNSIGNED32
Access	read / write
PDO mapping	no
Allowed values	
Preset value	00000000 <sub>h</sub>
Subindex	05 <sub>h</sub>
Name	5th Object To Be Mapped
Data type	UNSIGNED32
Access	read / write
PDO mapping	no
Allowed values	
Preset value	00000000 <sub>h</sub>
Subindex	06 <sub>h</sub>
Name	6th Object To Be Mapped
Data type	UNSIGNED32
Access	read / write
PDO mapping	no
Allowed values	
Preset value	00000000 <sub>h</sub>
Subindex	07 <sub>h</sub>
Name	7th Object To Be Mapped
Data type	UNSIGNED32
Access	read / write
PDO mapping	no
Allowed values	
Preset value	00000000 <sub>h</sub>
Subindex	08 <sub>h</sub>
Name	8th Object To Be Mapped
Data type	UNSIGNED32
Access	read / write
PDO mapping	no
Allowed values	
Preset value	00000000 <sub>h</sub>

## Description

Each subindex (1–8) describes a different mapped object.

A mapping entry consists of four bytes, which are structured according to the following graphic.

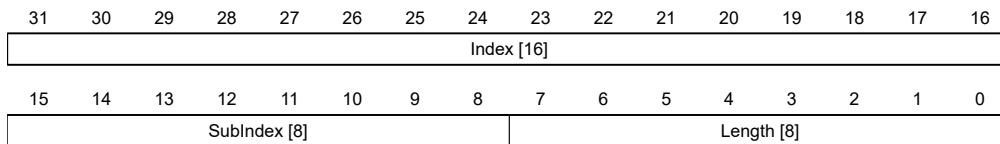

**Index [16]**

This contains the index of the object to be mapped.

**Subindex [8]**

This contains the subindex of the object to be mapped.

**Length [8]**

This contains the length of the object to be mapped in units of bits.

## 1A05h Transmit PDO 6 Mapping Parameter

### Function

This object contains the mapping parameters for PDOs that the controller can send (TX-PDO 6). The PDO was previously configured via [1805h Transmit PDO 6 Communication Parameter](#). See chapter [Process Data Object \(PDO\)](#).

### Object description

Index	1A05 <sub>h</sub>
Object name	Transmit PDO 6 Mapping Parameter
Object Code	RECORD
Data type	PDO_MAPPING
Savable	yes, category: communication
Access	read / write
PDO mapping	no
Allowed values	
Preset value	
Firmware version	FIR-v1614
Change history	

### Value description

Subindex	00 <sub>h</sub>
Name	Number Of Entries
Data type	UNSIGNED8
Access	read / write
PDO mapping	no
Allowed values	
Preset value	00 <sub>h</sub>

Subindex	01 <sub>h</sub>
Name	1st Object To Be Mapped
Data type	UNSIGNED32

Access	read / write
PDO mapping	no
Allowed values	
Preset value	00000000 <sub>h</sub>

---

Subindex	02 <sub>h</sub>
Name	2nd Object To Be Mapped
Data type	UNSIGNED32
Access	read / write
PDO mapping	no
Allowed values	
Preset value	00000000 <sub>h</sub>

---

Subindex	03 <sub>h</sub>
Name	3rd Object To Be Mapped
Data type	UNSIGNED32
Access	read / write
PDO mapping	no
Allowed values	
Preset value	00000000 <sub>h</sub>

---

Subindex	04 <sub>h</sub>
Name	4th Object To Be Mapped
Data type	UNSIGNED32
Access	read / write
PDO mapping	no
Allowed values	
Preset value	00000000 <sub>h</sub>

---

Subindex	05 <sub>h</sub>
Name	5th Object To Be Mapped
Data type	UNSIGNED32
Access	read / write
PDO mapping	no
Allowed values	
Preset value	00000000 <sub>h</sub>

---

Subindex	06 <sub>h</sub>
Name	6th Object To Be Mapped
Data type	UNSIGNED32
Access	read / write
PDO mapping	no
Allowed values	

Preset value	00000000 <sub>h</sub>
Subindex	07 <sub>h</sub>
Name	7th Object To Be Mapped
Data type	UNSIGNED32
Access	read / write
PDO mapping	no
Allowed values	
Preset value	00000000 <sub>h</sub>
Subindex	08 <sub>h</sub>
Name	8th Object To Be Mapped
Data type	UNSIGNED32
Access	read / write
PDO mapping	no
Allowed values	
Preset value	00000000 <sub>h</sub>

## Description

Each subindex (1–8) describes a different mapped object.

A mapping entry consists of four bytes, which are structured according to the following graphic.

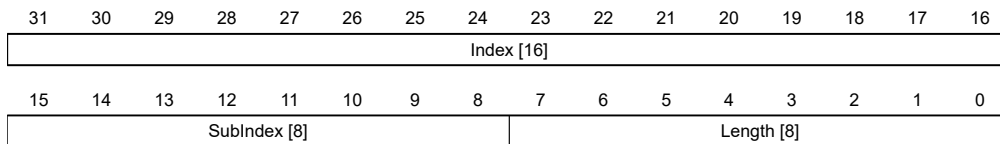

### Index [16]

This contains the index of the object to be mapped.

### Subindex [8]

This contains the subindex of the object to be mapped.

### Length [8]

This contains the length of the object to be mapped in units of bits.

## 1A06h Transmit PDO 7 Mapping Parameter

### Function

This object contains the mapping parameters for PDOs that the controller can send (TX-PDO 7). The PDO was previously configured via [1806h Transmit PDO 7 Communication Parameter](#). See chapter [Process Data Object \(PDO\)](#).

### Object description

Index	1A06 <sub>h</sub>
Object name	Transmit PDO 7 Mapping Parameter

Object Code	RECORD
Data type	PDO_MAPPING
Savable	yes, category: communication
Access	read / write
PDO mapping	no
Allowed values	
Preset value	
Firmware version	FIR-v1614
Change history	

---

## Value description

Subindex	00 <sub>h</sub>
Name	Number Of Entries
Data type	UNSIGNED8
Access	read / write
PDO mapping	no
Allowed values	
Preset value	00 <sub>h</sub>

---

Subindex	01 <sub>h</sub>
Name	1st Object To Be Mapped
Data type	UNSIGNED32
Access	read / write
PDO mapping	no
Allowed values	
Preset value	00000000 <sub>h</sub>

---

Subindex	02 <sub>h</sub>
Name	2nd Object To Be Mapped
Data type	UNSIGNED32
Access	read / write
PDO mapping	no
Allowed values	
Preset value	00000000 <sub>h</sub>

---

Subindex	03 <sub>h</sub>
Name	3rd Object To Be Mapped
Data type	UNSIGNED32
Access	read / write
PDO mapping	no
Allowed values	
Preset value	00000000 <sub>h</sub>

---

Subindex	04 <sub>h</sub>
Name	4th Object To Be Mapped
Data type	UNSIGNED32
Access	read / write
PDO mapping	no
Allowed values	
Preset value	00000000 <sub>h</sub>
Subindex	05 <sub>h</sub>
Name	5th Object To Be Mapped
Data type	UNSIGNED32
Access	read / write
PDO mapping	no
Allowed values	
Preset value	00000000 <sub>h</sub>
Subindex	06 <sub>h</sub>
Name	6th Object To Be Mapped
Data type	UNSIGNED32
Access	read / write
PDO mapping	no
Allowed values	
Preset value	00000000 <sub>h</sub>
Subindex	07 <sub>h</sub>
Name	7th Object To Be Mapped
Data type	UNSIGNED32
Access	read / write
PDO mapping	no
Allowed values	
Preset value	00000000 <sub>h</sub>
Subindex	08 <sub>h</sub>
Name	8th Object To Be Mapped
Data type	UNSIGNED32
Access	read / write
PDO mapping	no
Allowed values	
Preset value	00000000 <sub>h</sub>

## Description

Each subindex (1–8) describes a different mapped object.

A mapping entry consists of four bytes, which are structured according to the following graphic.

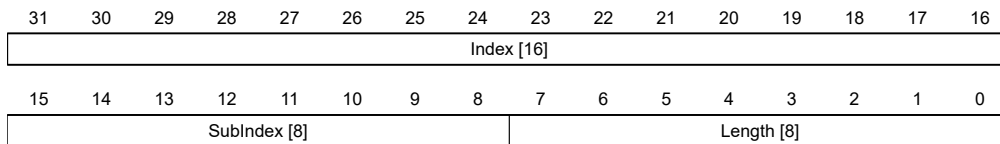
**Index [16]**

This contains the index of the object to be mapped.

**Subindex [8]**

This contains the subindex of the object to be mapped.

**Length [8]**

This contains the length of the object to be mapped in units of bits.

## 1A07h Transmit PDO 8 Mapping Parameter

### Function

This object contains the mapping parameters for PDOs that the controller can send (TX-PDO 8). The PDO was previously configured via [1807h Transmit PDO 8 Communication Parameter](#). See chapter [Process Data Object \(PDO\)](#).

### Object description

Index	1A07 <sub>h</sub>
Object name	Transmit PDO 8 Mapping Parameter
Object Code	RECORD
Data type	PDO_MAPPING
Savable	yes, category: communication
Access	read / write
PDO mapping	no
Allowed values	
Preset value	
Firmware version	FIR-v1614
Change history	

### Value description

Subindex	00 <sub>h</sub>
Name	Number Of Entries
Data type	UNSIGNED8
Access	read / write
PDO mapping	no
Allowed values	
Preset value	00 <sub>h</sub>

Subindex	01 <sub>h</sub>
Name	1st Object To Be Mapped
Data type	UNSIGNED32

Access	read / write
PDO mapping	no
Allowed values	
Preset value	00000000 <sub>h</sub>

---

Subindex	02 <sub>h</sub>
Name	2nd Object To Be Mapped
Data type	UNSIGNED32
Access	read / write
PDO mapping	no
Allowed values	
Preset value	00000000 <sub>h</sub>

---

Subindex	03 <sub>h</sub>
Name	3rd Object To Be Mapped
Data type	UNSIGNED32
Access	read / write
PDO mapping	no
Allowed values	
Preset value	00000000 <sub>h</sub>

---

Subindex	04 <sub>h</sub>
Name	4th Object To Be Mapped
Data type	UNSIGNED32
Access	read / write
PDO mapping	no
Allowed values	
Preset value	00000000 <sub>h</sub>

---

Subindex	05 <sub>h</sub>
Name	5th Object To Be Mapped
Data type	UNSIGNED32
Access	read / write
PDO mapping	no
Allowed values	
Preset value	00000000 <sub>h</sub>

---

Subindex	06 <sub>h</sub>
Name	6th Object To Be Mapped
Data type	UNSIGNED32
Access	read / write
PDO mapping	no
Allowed values	

Preset value	00000000 <sub>h</sub>
Subindex	07 <sub>h</sub>
Name	7th Object To Be Mapped
Data type	UNSIGNED32
Access	read / write
PDO mapping	no
Allowed values	
Preset value	00000000 <sub>h</sub>
Subindex	08 <sub>h</sub>
Name	8th Object To Be Mapped
Data type	UNSIGNED32
Access	read / write
PDO mapping	no
Allowed values	
Preset value	00000000 <sub>h</sub>

### Description

Each subindex (1–8) describes a different mapped object.

A mapping entry consists of four bytes, which are structured according to the following graphic.

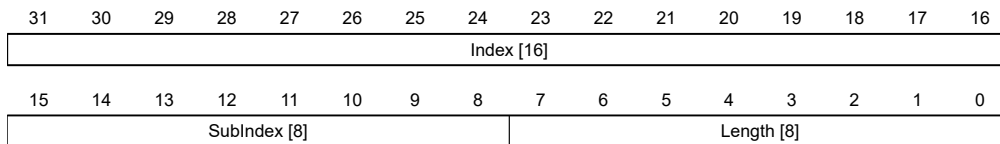

#### Index [16]

This contains the index of the object to be mapped.

#### Subindex [8]

This contains the subindex of the object to be mapped.

#### Length [8]

This contains the length of the object to be mapped in units of bits.

## 1F50h Program Data

### Function

This object is used to program memory areas of the controller. Each entry stands for a certain memory area.

### Object description

Index	1F50 <sub>h</sub>
Object name	Program Data
Object Code	ARRAY
Data type	DOMAIN



Savable	no
Access	read only
PDO mapping	no
Allowed values	
Preset value	
Firmware version	FIR-v1540
Change history	

---

## Value description

Subindex	00 <sub>h</sub>
Name	Number Of Entries
Data type	UNSIGNED8
Access	read only
PDO mapping	no
Allowed values	
Preset value	02 <sub>h</sub>

---

Subindex	01 <sub>h</sub>
Name	Program Data Bootloader/firmware
Data type	DOMAIN
Access	read / write
PDO mapping	no
Allowed values	
Preset value	0

---

Subindex	02 <sub>h</sub>
Name	Program Data NanoJ
Data type	DOMAIN
Access	read / write
PDO mapping	no
Allowed values	
Preset value	0

---

## 1F51h Program Control

### Function

This object is used to control the programming of memory areas of the controller. Each entry stands for a certain memory area.

### Object description

Index	1F51 <sub>h</sub>
Object name	Program Control
Object Code	ARRAY

Data type	UNSIGNED8
Savable	no
Access	read only
PDO mapping	no
Allowed values	
Preset value	
Firmware version	FIR-v1540
Change history	

---

### Value description

Subindex	00 <sub>h</sub>
Name	Number Of Entries
Data type	UNSIGNED8
Access	read only
PDO mapping	no
Allowed values	
Preset value	02 <sub>h</sub>

---

Subindex	01 <sub>h</sub>
Name	Program Control Bootloader/firmware
Data type	UNSIGNED8
Access	read / write
PDO mapping	no
Allowed values	
Preset value	00 <sub>h</sub>

---

Subindex	02 <sub>h</sub>
Name	Program Control NanoJ
Data type	UNSIGNED8
Access	read / write
PDO mapping	no
Allowed values	
Preset value	00 <sub>h</sub>

---

## 1F57h Program Status

### Function

This object indicates the programming status during the programming of memory areas of the controller. Each entry stands for a certain memory area.

### Object description

Index	1F57 <sub>h</sub>
Object name	Program Status

Object Code	ARRAY
Data type	UNSIGNED32
Savable	no
Access	read only
PDO mapping	no
Allowed values	
Preset value	
Firmware version	FIR-v1540
Change history	

---

## Value description

Subindex	00 <sub>h</sub>
Name	Number Of Entries
Data type	UNSIGNED8
Access	read only
PDO mapping	no
Allowed values	
Preset value	02 <sub>h</sub>

---

Subindex	01 <sub>h</sub>
Name	Program Status Bootloader/firmware
Data type	UNSIGNED32
Access	read only
PDO mapping	no
Allowed values	
Preset value	00000000 <sub>h</sub>

---

Subindex	02 <sub>h</sub>
Name	Program Status NanoJ
Data type	UNSIGNED32
Access	read only
PDO mapping	no
Allowed values	
Preset value	00000000 <sub>h</sub>

---

## 1F80h NMT Startup

### Function

In this object you can set whether, after starting the controller, the state is automatically switched to the NMT state *Operational*. See also chapter [Network Management \(NMT\)](#).

### Object description

Index	1F80 <sub>h</sub>
-------	-------------------

---

Object name	NMT Startup
Object Code	VARIABLE
Data type	UNSIGNED32
Savable	yes, category: communication
Access	read / write
PDO mapping	no
Allowed values	
Preset value	00000000 <sub>h</sub>
Firmware version	FIR-v1748-B531667
Change history	

## Description

- Value "0"<sub>h</sub>: The state of the NMT state machine after initialization is *Pre-Operational*.
- Value "8"<sub>h</sub> (bit 3): The state of the NMT state machine after initialization is *Operational*.

## 2005h CANopen Baudrate

### Function

This object contains the baud rate of the CANopen bus.

### Object description

Index	2005 <sub>h</sub>
Object name	CANopen Baudrate
Object Code	VARIABLE
Data type	UNSIGNED8
Savable	yes, category: CANopen
Access	read / write
PDO mapping	no
Allowed values	
Preset value	88 <sub>h</sub>
Firmware version	FIR-v1426
Change history	Firmware version FIR-v1748-B531667: "Savable" entry changed from "yes, category: communication" to "yes, category: CANopen".

## Description

The baud rates are to be set according to the following table. Each value outside of this table is interpreted as 1000 kBd.

Value		Baud rate in kBd
dec	hex	
129	81	10
130	82	20
131	83	50
132	84	125

Value		Baud rate in kBd
dec	hex	
133	85	250
134	86	500
136	88	1000

## 2006h CANopen WheelConfig

### Function

This object switches the counting method of the CANopen rotary switch.

### Object description

Index	2006 <sub>h</sub>
Object name	CANopen WheelConfig
Object Code	ARRAY
Data type	UNSIGNED8
Savable	yes, category: CANopen
Access	read only
PDO mapping	no
Allowed values	
Preset value	
Firmware version	FIR-v1426
Change history	<p>Firmware version FIR-v1540: "Object Name" entry changed from "CANopen WheelConf" to "CANopen WheelConfig".</p> <p>Firmware version FIR-v1748-B531667: "Savable" entry changed from "yes, category: communication" to "yes, category: CANopen".</p> <p>Firmware version FIR-v2039-B807052: "Name" entry changed from "Highest Sub-index Supported" to "Number Of Entries".</p>

### Value description

Subindex	00 <sub>h</sub>
Name	Number Of Entries
Data type	UNSIGNED8
Access	read only
PDO mapping	no
Allowed values	
Preset value	02 <sub>h</sub>
Subindex	01 <sub>h</sub>
Name	Wheel Mode
Data type	UNSIGNED8
Access	read / write

PDO mapping	no
Allowed values	0 or 1
Preset value	00 <sub>h</sub>

Subindex	02 <sub>h</sub>
Name	NodeID Offset
Data type	UNSIGNED8
Access	read / write
PDO mapping	no
Allowed values	0 ... 112
Preset value	00 <sub>h</sub>

## Description

The subindices have the following functions:

- 01<sub>h</sub>: Offset setting
  - Value "0": The value of the CANopen rotary switch is accepted unchanged.
  - Value "1": The value of the CANopen rotary switch is added to the offset in subindex 02<sub>h</sub>.
- 02: Node-ID Offset; the value may be between 0 and 112 and is added to the value of the CANopen rotary switch if subindex 01<sub>h</sub> is set to the value "1".

## 2007h CANopen Config

### Function

This object can be used to perform various settings for CANopen.

### Object description

Index	2007 <sub>h</sub>
Object name	CANopen Config
Object Code	ARRAY
Data type	UNSIGNED32
Savable	yes, category: CANopen
Access	read only
PDO mapping	no
Allowed values	
Preset value	
Firmware version	FIR-v1540
Change history	Firmware version FIR-v1748-B531667: "Savable" entry changed from "yes, category: communication" to "yes, category: CANopen".

### Value description

Subindex	00 <sub>h</sub>
Name	Number Of Entries
Data type	UNSIGNED8

Access	read only
PDO mapping	no
Allowed values	
Preset value	01 <sub>h</sub>

---

Subindex	01 <sub>h</sub>
Name	BL Config
Data type	UNSIGNED32
Access	read / write
PDO mapping	no
Allowed values	
Preset value	00000000 <sub>h</sub>

---

## Description

The subindices have the following functions:

- Subindex 01: If the value "1" is written in the object, the boot loader suppresses the boot-up message and only the firmware sends a BOOTUP message. With a "0", the boot loader and the firmware each send a BOOTUP message.

## 2009h CANopen NodeID

### Function

This object contains the node-ID of the controller. See chapter *Commissioning*.

### Object description

Index	2009 <sub>h</sub>
Object name	CANopen NodeID
Object Code	VARIABLE
Data type	UNSIGNED8
Savable	yes, category: CANopen
Access	read / write
PDO mapping	no
Allowed values	
Preset value	7F <sub>h</sub>
Firmware version	FIR-v1426
Change history	Firmware version FIR-v1748-B531667: "Savable" entry changed from "yes, category: communication" to "yes, category: CANopen".

---

## 2030h Pole Pair Count

### Function

Contains the number of pole pairs of the connected motor.

## Object description

Index	2030 <sub>h</sub>
Object name	Pole Pair Count
Object Code	VARIABLE
Data type	UNSIGNED32
Savable	yes, category: tuning
Access	read / write
PDO mapping	no
Allowed values	
Preset value	00000032 <sub>h</sub>
Firmware version	FIR-v1426
Change history	Firmware version FIR-v1540: "Savable" entry changed from "no" to "yes, category: tuning".

## 2031h Max Motor Current

### Function

Enter the maximum permissible motor current in milliamperes here. All current values are limited by this value.

Within the controller, the entered value is always interpreted as the root mean square.

### Object description

Index	2031 <sub>h</sub>
Object name	Max Motor Current
Object Code	VARIABLE
Data type	UNSIGNED32
Savable	yes, category: tuning
Access	read / write
PDO mapping	no
Allowed values	
Preset value	00000258 <sub>h</sub>
Firmware version	FIR-v1426
Change history	<p>Firmware version FIR-v1614: "Savable" entry changed from "yes, category: application" to "yes, category: tuning".</p> <p>Firmware version FIR-v1614: "Object Name" entry changed from "Peak Current" to "Max Current".</p> <p>Firmware version FIR-v1748-B538662: "Object Name" entry changed from "Maximum Current" to "Max Motor Current".</p> <p>Firmware version FIR-v1825-B577172: "Object Name" entry changed from "Max Motor Current" to "Maximum Current".</p> <p>Firmware version FIR-v1825-B577172: "Object Name" entry changed from "Maximum Current" to "Max Motor Current".</p> <p>Firmware version FIR-v1825-B577172: "Object Name" entry changed from "Max Motor Current" to "Maximum Current".</p>



Firmware version FIR-v1825-B577172: "Object Name" entry changed from "Maximum Current" to "Max Motor Current".

---

## 2034h Upper Voltage Warning Level

### Function

This object contains the threshold value for the "overvoltage" error in millivolts.

### Object description

---

Index	2034 <sub>h</sub>
Object name	Upper Voltage Warning Level
Object Code	VARIABLE
Data type	UNSIGNED32
Savable	yes, category: application
Access	read / write
PDO mapping	no
Allowed values	
Preset value	0000EF3D <sub>h</sub>
Firmware version	FIR-v1426
Change history	

---

### Description

If the input voltage of the controller exceeds this threshold value, the motor is switched off and an error triggered. This error is reset automatically if the input voltage is less than (voltage of object 2034<sub>h</sub> minus 2 volts).

## 2035h Lower Voltage Warning Level

### Function

This object contains the threshold value for the "Undervoltage" error in millivolts.

### Object description

---

Index	2035 <sub>h</sub>
Object name	Lower Voltage Warning Level
Object Code	VARIABLE
Data type	UNSIGNED32
Savable	yes, category: application
Access	read / write
PDO mapping	no
Allowed values	
Preset value	00002710 <sub>h</sub>
Firmware version	FIR-v1426
Change history	

---

## Description

If the input voltage of the controller falls below this threshold value, the motor is switched off and an error triggered. The error is reset automatically if the input voltage exceeds the voltage of object 2035<sub>h</sub> plus 1.5 volts.

## 2036h Open Loop Current Reduction Idle Time

### Function

This object describes the time in milliseconds that the motor must be at a standstill before current reduction is activated.

### Object description

---

Index	2036 <sub>h</sub>
Object name	Open Loop Current Reduction Idle Time
Object Code	VARIABLE
Data type	UNSIGNED32
Savable	yes, category: application
Access	read / write
PDO mapping	no
Allowed values	
Preset value	000003E8 <sub>h</sub>
Firmware version	FIR-v1426
Change history	

---

## 2037h Open Loop Current Reduction Value/factor

### Function

This object describes the rms current to which the motor current is to be reduced if current reduction is activated in open loop (bit 3 in 3202<sub>h</sub> = "1") and the motor is at a standstill.

### Object description

---

Index	2037 <sub>h</sub>
Object name	Open Loop Current Reduction Value/factor
Object Code	VARIABLE
Data type	INTEGER32
Savable	yes, category: application
Access	read / write
PDO mapping	no
Allowed values	
Preset value	FFFFFFCE <sub>h</sub>
Firmware version	FIR-v1426
Change history	

---

## Description

### Value of 2037<sub>h</sub> greater than or equal to 0 and less than value 6075<sub>h</sub>

Current is reduced to the value entered here. The value is in mA and interpreted as root mean square.

### Value of 2037<sub>h</sub> in the range from -1 to -100

The entered value is interpreted as a percentage and determines the reduction of the rated current in 2037<sub>h</sub>. The value in 6075<sub>h</sub> is used for the calculation.

Example: Object 6075<sub>h</sub> has the value 4200 mA. The value -60 in 2037<sub>h</sub> reduces the current by 60% of 6075<sub>h</sub>. The result is a current reduction to a root mean square of 6075<sub>h</sub> \* (2037<sub>h</sub> + 100) / 100 = 1680 mA.

The value -100 in 2037<sub>h</sub> would, for example, mean that a current reduction is set to a root mean square of 0 mA.

## 2038h Brake Controller Timing

### Function

This object contains the times for the *brake control* in milliseconds as well as the PWM frequency and the duty cycle.

### Object description

Index	2038 <sub>h</sub>
Object name	Brake Controller Timing
Object Code	ARRAY
Data type	UNSIGNED32
Savable	yes, category: application
Firmware version	FIR-v1426
Change history	

### Value description

Subindex	00 <sub>h</sub>
Name	Number Of Entries
Data type	UNSIGNED8
Access	read only
PDO mapping	no
Allowed values	
Preset value	06 <sub>h</sub>

Subindex	01 <sub>h</sub>
Name	Close Brake Idle Time
Data type	UNSIGNED32
Access	read / write
PDO mapping	no
Allowed values	

Preset value	000003E8 <sub>h</sub>
Subindex	02 <sub>h</sub>
Name	Shutdown Power Idle Time
Data type	UNSIGNED32
Access	read / write
PDO mapping	no
Allowed values	
Preset value	000003E8 <sub>h</sub>
Subindex	03 <sub>h</sub>
Name	Open Brake Delay Time
Data type	UNSIGNED32
Access	read / write
PDO mapping	no
Allowed values	
Preset value	000003E8 <sub>h</sub>
Subindex	04 <sub>h</sub>
Name	Start Operation Delay Time
Data type	UNSIGNED32
Access	read / write
PDO mapping	no
Allowed values	
Preset value	00000000 <sub>h</sub>
Subindex	05 <sub>h</sub>
Name	PWM Frequency
Data type	UNSIGNED32
Access	read / write
PDO mapping	no
Allowed values	between 0 and 50 (brake output) and 2000 (7D0 <sub>h</sub> )
Preset value	00000000 <sub>h</sub>
Subindex	06 <sub>h</sub>
Name	PWM Duty Cycle
Data type	UNSIGNED32
Access	read / write
PDO mapping	no
Allowed values	0, between 2 and 100 (64 <sub>h</sub> )
Preset value	00000000 <sub>h</sub>

## Description

The subindices have the following functions:

- 01<sub>h</sub>: Time between motor standstill and the closing of the brake.
- 02<sub>h</sub>: Time between the closing of the brake and the switching off of the motor current.
- 03<sub>h</sub>: Time between the switching on of the motor current and opening of the brake.
- 04<sub>h</sub>: Time between the opening of the brake and when the *Operation enabled* state of the CiA 402 Power State Machine is reached.
- 05<sub>h</sub>: Frequency of the PWM signal in hertz.
- 06<sub>h</sub>: Duty cycle of the PWM signal in percent.

## 2039h Motor Currents

### Function

This object contains the measured motor currents in mA. All values are peak values, (#2\*rms).

### Object description

Index	2039 <sub>h</sub>
Object name	Motor Currents
Object Code	ARRAY
Data type	INTEGER32
Savable	no
Access	read only
PDO mapping	no
Allowed values	
Preset value	
Firmware version	FIR-v1426
Change history	<p>Firmware version FIR-v1504: "PDO mapping" table entry for subindex 01 changed from "no" to "TX-PDO".</p> <p>Firmware version FIR-v1504: "PDO mapping" table entry for subindex 02 changed from "no" to "TX-PDO".</p> <p>Firmware version FIR-v1504: "PDO mapping" table entry for subindex 03 changed from "no" to "TX-PDO".</p> <p>Firmware version FIR-v1504: "PDO mapping" table entry for subindex 04 changed from "no" to "TX-PDO".</p> <p>Firmware version FIR-v2213: subindex 05<sub>h</sub>, "Actual Current" added. Phase currents I<sub>a</sub> and I<sub>b</sub> changed to I<sub>α</sub> and I<sub>β</sub> (Clarke transformation).</p>

### Value description

Subindex	00 <sub>h</sub>
Name	Number Of Entries
Data type	UNSIGNED8
Access	read only
PDO mapping	no
Allowed values	
Preset value	05 <sub>h</sub>

Subindex	01 <sub>h</sub>
Name	Id
Data type	INTEGER32
Access	read only
PDO mapping	TX-PDO
Allowed values	
Preset value	00000000 <sub>h</sub>
Subindex	02 <sub>h</sub>
Name	Iq
Data type	INTEGER32
Access	read only
PDO mapping	TX-PDO
Allowed values	
Preset value	00000000 <sub>h</sub>
Subindex	03 <sub>h</sub>
Name	I $\alpha$
Data type	INTEGER32
Access	read only
PDO mapping	TX-PDO
Allowed values	
Preset value	00000000 <sub>h</sub>
Subindex	04 <sub>h</sub>
Name	I $\beta$
Data type	INTEGER32
Access	read only
PDO mapping	TX-PDO
Allowed values	
Preset value	00000000 <sub>h</sub>
Subindex	05 <sub>h</sub>
Name	Actual Current
Data type	INTEGER32
Access	read only
PDO mapping	TX-PDO
Allowed values	
Preset value	00000000 <sub>h</sub>

## Description

- 01<sub>h</sub>: Field-forming components of the current
- 02<sub>h</sub>: Torque-forming components of the current

- 03<sub>h</sub>: I<sub>α</sub>
- 04<sub>h</sub>: I<sub>β</sub>
- 05<sub>h</sub>: total current divided by  $\sqrt{2}$ , i.e., calculated down to a motor phase. In *closed-loop*, the sign of I<sub>q</sub> is also used. The current value can then be placed on a scale to compare with the current from 6075<sub>h</sub>, 2031<sub>h</sub> and 203B<sub>h</sub>:05<sub>h</sub>.  
*open-loop*:  $I = \sqrt{(I_{\alpha}^2 + I_{\beta}^2)} / \sqrt{2}$   
*Closed Loop*:  $I = \text{sgn}(I_q) * \sqrt{(I_{\alpha}^2 + I_{\beta}^2)} / \sqrt{2}$

**NOTICE**



Motor currents I<sub>d</sub> (subindex 01<sub>h</sub>) and I<sub>q</sub> (subindex 02<sub>h</sub>) are only displayed if closed-loop was activated; the value 0 is otherwise output.

## 203Ah Homing On Block Configuration

### Function

This object contains the parameters for *Homing on Block* (see chapter [Homing](#)).

### Object description

Index	203A <sub>h</sub>
Object name	Homing On Block Configuration
Object Code	ARRAY
Data type	INTEGER32
Savable	yes, category: application
Access	
PDO mapping	
Allowed values	
Preset value	
Firmware version	FIR-v1426
Change history	<p>Firmware version FIR-v1540: The number of entries was changed from 4 to 3.</p> <p>Firmware version FIR-v1540: "Name" entry changed from "Period Of Blocking" to "Block Detection time".</p> <p>Firmware version FIR-v1614: "Data Type" entry changed from "UNSIGNED32" to "INTEGER32".</p> <p>Firmware version FIR-v1614: "Savable" entry changed from "no" to "yes, category: application".</p> <p>Firmware version FIR-v1614: "Data Type" entry changed from "UNSIGNED32" to "INTEGER32".</p> <p>Firmware version FIR-v1614: "Data Type" entry changed from "UNSIGNED32" to "INTEGER32".</p>

### Value description

Subindex	00 <sub>h</sub>
Name	Number Of Entries

Data type	UNSIGNED8
Access	read only
PDO mapping	no
Allowed values	
Preset value	02 <sub>h</sub>

Subindex	01 <sub>h</sub>
Name	Minimum Current For Block Detection
Data type	INTEGER32
Access	read / write
PDO mapping	no
Allowed values	
Preset value	000005DC <sub>h</sub>

Subindex	02 <sub>h</sub>
Name	Block Detection Time
Data type	INTEGER32
Access	read / write
PDO mapping	no
Allowed values	
Preset value	000000C8 <sub>h</sub>

## Description

The subindices have the following function:

- 01<sub>h</sub>: Specifies the current limit value above which blocking is to be detected. Positive numerical values specify the current limit in mA, negative numbers specify a percentage of object 2031<sub>h</sub>. Example: The value "1000" corresponds to 1000 mA (= 1 A); the value "-70" corresponds to 70% of 2031<sub>h</sub>.
- 02<sub>h</sub>: Specifies the time in ms that the motor is to continue to travel against the block after block detection.

## 203Bh I2t Parameters

### Function

This object contains the parameters for I<sup>2</sup>t monitoring.

I<sup>2</sup>t monitoring is activated by entering a value greater than 0 in 203B<sub>h</sub>:01 and 203B<sub>h</sub>:02 and a value greater than 1000 in 6073<sub>h</sub> (see I2t Motor overload protection).

With one exception, I<sup>2</sup>t monitoring can only be used for *closed loop* mode: If I<sup>2</sup>t is activated in *open loop* mode, the current is reduced to the smaller of 203B<sub>h</sub>:01<sub>h</sub>, 6073<sub>h</sub> and 2031<sub>h</sub>.

### Object description

Index	203B <sub>h</sub>
Object name	I2t Parameters
Object Code	ARRAY
Data type	UNSIGNED32
Savable	yes, category: tuning
Firmware version	FIR-v1426



Change history	Firmware version FIR-v1512: "Savable" entry changed from "no" to "yes, category: application".
	Firmware version FIR-v1512: The number of entries was changed from 7 to 8.
	Firmware version FIR-v1614: "Savable" entry changed from "yes, category: application" to "yes, category: tuning".
	Firmware version FIR-v1748-B538662: "Name" entry changed from "Nominal Current" to "Motor Rated Current".
	Firmware version FIR-v1825-B577172: "Name" entry changed from "Motor Rated Current" to "Nominal Current".
	Firmware version FIR-v1825-B577172: "Name" entry changed from "Nominal Current" to "Motor Rated Current".
	Firmware version FIR-v1825-B577172: "Name" entry changed from "Motor Rated Current" to "Nominal Current".
	Firmware version FIR-v1825-B577172: "Name" entry changed from "Nominal Current" to "Motor Rated Current".
	Firmware version FIR-v1825-B577172: The number of entries was changed from 8 to 7.
	Firmware version FIR-v1926-B648637: "Name" entry changed from "Maximum Duration Of Peak Current" to "Maximum Duration Of Max Current".

## Value description

Subindex	00 <sub>h</sub>
Name	Number Of Entries
Data type	UNSIGNED8
Access	read only
PDO mapping	no
Allowed values	
Preset value	06 <sub>h</sub>
Subindex	01 <sub>h</sub>
Name	Motor Rated Current
Data type	UNSIGNED32
Access	read / write
PDO mapping	no
Allowed values	
Preset value	00000258 <sub>h</sub>
Subindex	02 <sub>h</sub>
Name	Maximum Duration Of Max Current
Data type	UNSIGNED32
Access	read / write
PDO mapping	no

Allowed values	
Preset value	00000000 <sub>h</sub>
<hr/>	
Subindex	03 <sub>h</sub>
Name	Threshold
Data type	UNSIGNED32
Access	read / write
PDO mapping	no
Allowed values	
Preset value	00000000 <sub>h</sub>
<hr/>	
Subindex	04 <sub>h</sub>
Name	CalcValue
Data type	UNSIGNED32
Access	read / write
PDO mapping	no
Allowed values	
Preset value	00000000 <sub>h</sub>
<hr/>	
Subindex	05 <sub>h</sub>
Name	LimitedCurrent
Data type	UNSIGNED32
Access	read / write
PDO mapping	no
Allowed values	
Preset value	00000000 <sub>h</sub>
<hr/>	
Subindex	06 <sub>h</sub>
Name	Status
Data type	UNSIGNED32
Access	read / write
PDO mapping	no
Allowed values	
Preset value	00000000 <sub>h</sub>

## Description

The subindices are divided into two groups: subindex 01<sub>h</sub> and 02<sub>h</sub> contain parameters for control, subindices 03<sub>h</sub> to 06<sub>h</sub> are status values. The functions are as follows:

- 01<sub>h</sub>: The rated current specified in the motor data sheet is entered here in mA. This must be smaller than the current entered in 2031<sub>h</sub> and 6073<sub>h</sub>, otherwise monitoring is not activated. The specified value is interpreted as root mean square.
- 02<sub>h</sub>: Specifies the maximum duration of the maximum current (6073<sub>h</sub>) in ms.
- 03<sub>h</sub>: Threshold, specifies the limit in A<sup>2</sup>ms that determines whether the maximum current or rated current is switched to.

- 04<sub>h</sub>: CalcValue, specifies the calculated value in A<sup>2</sup>ms that is compared with the threshold for setting the current.
- 05<sub>h</sub>: LimitedCurrent, contains the momentary current as root mean square set by I<sup>2</sup>t.
- 06<sub>h</sub>: Current status. If the sub-entry value is "0", I<sup>2</sup>t is deactivated; if the value is "1", I<sup>2</sup>t is activated.

## 203Dh Torque Window

### Function

Specifies a symmetrical range relative to the target torque within which the target is considered having been met.

If the value is set to "FFFFFFF"<sub>h</sub>, monitoring is switched off, the "Target reached" bit in object 6041<sub>h</sub> (statusword) is never set.

### Object description

Index	203D <sub>h</sub>
Object name	Torque Window
Object Code	VARIABLE
Data type	UNSIGNED16
Savable	yes, category: application
Access	read / write
PDO mapping	RX-PDO
Allowed values	
Preset value	0000 <sub>h</sub>
Firmware version	FIR-v1540
Change history	Firmware version FIR-v1614: "Savable" entry changed from "no" to "yes, category: application".

## 203Eh Torque Window Time Out

### Function

The current torque must be within the "Torque Window" (203D<sub>h</sub>) for this time (in milliseconds) for the target torque to be considered having been met.

### Object description

Index	203E <sub>h</sub>
Object name	Torque Window Time Out
Object Code	VARIABLE
Data type	UNSIGNED16
Savable	yes, category: application
Access	read / write
PDO mapping	RX-PDO
Allowed values	
Preset value	0000 <sub>h</sub>
Firmware version	FIR-v1540
Change history	Firmware version FIR-v1614: "Savable" entry changed from "no" to "yes, category: application".

Firmware version FIR-v1738-B501312: "Object Name" entry changed from "Torque Window Time" to "Torque Window Time Out".

---

## 203Fh Max Slippage Time Out

### Function

Time in milliseconds until an excessively large slippage error in Profile Velocity mode results in an error message.

### Object description

---

Index	203F <sub>h</sub>
Object name	Max Slippage Time Out
Object Code	VARIABLE
Data type	UNSIGNED16
Savable	yes, category: application
Access	read / write
PDO mapping	RX-PDO
Allowed values	
Preset value	0064 <sub>h</sub>
Firmware version	FIR-v1738-B501312
Change history	

---

### Description

If the actual speed deviates so much from the set speed that the value (absolute value) of the object 60F8<sub>h</sub> (Max Slippage) is exceeded, bit 13 in object 6041<sub>h</sub> is set. The deviation must last longer than the time in object 203F<sub>h</sub>.

A reaction to the slippage error can be set in object 3700<sub>h</sub>. If a reaction is defined, an error is also entered in object 1003<sub>h</sub>.

## 2057h Clock Direction Multiplier

### Function

The clock count value in Clock-direction mode is multiplied by this value before it is processed further.

### Object description

---

Index	2057 <sub>h</sub>
Object name	Clock Direction Multiplier
Object Code	VARIABLE
Data type	INTEGER32
Savable	yes, category: application
Access	read / write
PDO mapping	no
Allowed values	
Preset value	00000080 <sub>h</sub>
Firmware version	FIR-v1426

---

Change history

---

## 2058h Clock Direction Divider

### Function

The clock count value in Clock-direction mode is divided by this value before it is processed further.

### Object description

Index	2058 <sub>h</sub>
Object name	Clock Direction Divider
Object Code	VARIABLE
Data type	INTEGER32
Savable	yes, category: application
Access	read / write
PDO mapping	no
Allowed values	
Preset value	00000001 <sub>h</sub>
Firmware version	FIR-v1426
Change history	

## 205Ah Absolute Sensor Boot Value (in User Units)

### Function



**TIP**

This object only has a function when using an absolute encoder. If an absolute encoder is not used, the value is always 0.

The initial encoder position when switching on the controller (in user-defined units) can be read from this object.

### Object description

Index	205A <sub>h</sub>
Object name	Absolute Sensor Boot Value (in User Units)
Object Code	VARIABLE
Data type	INTEGER32
Savable	no
Access	read only
PDO mapping	no
Allowed values	
Preset value	00000000 <sub>h</sub>
Firmware version	FIR-v1446
Change history	Firmware version FIR-v1512: "Access" table entry for subindex 00 changed from "read/write" to "read only".

Firmware version FIR-v1738-B501312: "Object Name" entry changed from "Encoder Boot Value" to "Absolute Sensor Boot Value (in User Units)".

Firmware version FIR-v1738-B501312: "Data type" entry changed from "UNSIGNED32" to "INTEGER32".

## 205Bh Clock Direction Or Clockwise/Counter Clockwise Mode

### Function

This object can be used to switch the clock-direction mode (value = "0") to the right/left rotation mode (value = "1").

### Object description

Index	205B <sub>h</sub>
Object name	Clock Direction Or Clockwise/Counter Clockwise Mode
Object Code	VARIABLE
Data type	UNSIGNED32
Savable	yes, category: application
Access	read / write
PDO mapping	no
Allowed values	
Preset value	00000000 <sub>h</sub>
Firmware version	FIR-v1504
Change history	

## 2084h Bootup Delay

### Function

Defines the period between the time that supply voltage is applied to the controller and the functional readiness of the controller in milliseconds.

### Object description

Index	2084 <sub>h</sub>
Object name	Bootup Delay
Object Code	VARIABLE
Data type	UNSIGNED32
Savable	yes, category: application
Access	read / write
PDO mapping	no
Allowed values	
Preset value	00000000 <sub>h</sub>
Firmware version	FIR-v1426
Change history	

## 2101h Fieldbus Module Availability

### Function

Shows the available fieldbuses.

### Object description

Index	2101 <sub>h</sub>
Object name	Fieldbus Module Availability
Object Code	VARIABLE
Data type	UNSIGNED32
Savable	no
Access	read only
PDO mapping	no
Allowed values	
Preset value	00000008 <sub>h</sub>
Firmware version	FIR-v1426
Change history	Firmware version FIR-v1626: "Object Name" entry changed from "Fieldbus Module" to "Fieldbus Module Availability".

### Description

Bits 0 to 15 represent the physical interface, bits 16 to 31 the used protocol (if necessary).

31	30	29	28	27	26	25	24	23	22	21	20	19	18	17	16
													E-IP	MTCP	MRTU
15	14	13	12	11	10	9	8	7	6	5	4	3	2	1	0
									SPI	E-CAT	E-NET	CAN	RS232	RS485	USB

#### USB

Value = "1": The USB fieldbus is available.

#### RS-485

Value = "1": An RS-485 interface is available.

#### RS-232

Value = "1": An RS-232 interface is available.

#### CAN

Value = "1": The CANopen fieldbus is available.

#### E-NET

Value = "1": An Ethernet interface is available.

#### E-CAT

Value = "1": An EtherCAT interface is available.

#### SPI

Value = "1": An SPI interface is available.

#### MRTU

Value = "1": The used protocol is Modbus RTU.

**MTCP**

Value = "1": The used protocol is Modbus TCP

**E-IP**

Value = "1": The used protocol is EtherNet/IP™

**2102h Fieldbus Module Control**

**Function**

This object can be used to activate/deactivate certain fieldbuses (physical interfaces and protocols).

**Object description**

Index	2102 <sub>h</sub>
Object name	Fieldbus Module Control
Object Code	VARIABLE
Data type	UNSIGNED32
Savable	yes, category: communication
Access	read / write
PDO mapping	no
Allowed values	
Preset value	00000008 <sub>h</sub>
Firmware version	FIR-v1540
Change history	Firmware version FIR-v1626: "Savable" entry changed from "yes, category: application" to "yes, category: communication".

**Description**

Object 2103<sub>h</sub>:1<sub>h</sub> contains all physical interfaces/protocols that can be activated/deactivated. These can be switched in this object (2102<sub>h</sub>). The current status of the activated fieldbuses is in object 2103<sub>h</sub>:2<sub>h</sub>.

The following distribution of the bits applies here:

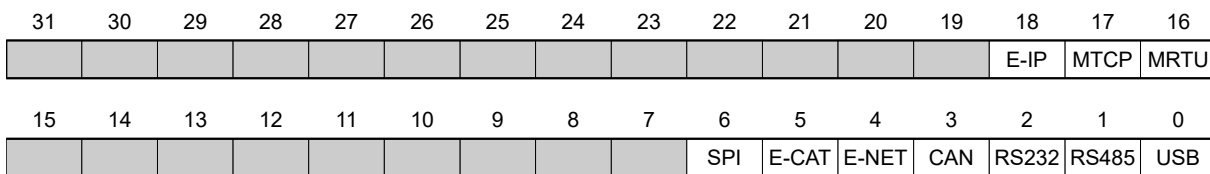

**USB**

USB interface

**RS-485**

RS-485 interface

**RS-232**

RS-232 interface

**CAN**

CANopen interface



**E-NET**

EtherNet interface

**E-CAT**

EtherCAT interface

**SPI**

SPI interface

**MRTU**

Modbus RTU protocol

**MTCP**

Modbus TCP protocol

**E-IP**

EtherNet/IP™ protocol

**2103h Fieldbus Module Status****Function**

Shows the active fieldbuses.

**Object description**

Index	2103 <sub>h</sub>
Object name	Fieldbus Module Status
Object Code	ARRAY
Data type	UNSIGNED32
Savable	no
Access	read only
PDO mapping	no
Allowed values	
Preset value	
Firmware version	FIR-v1540
Change history	

**Value description**

Subindex	00 <sub>h</sub>
Name	Number Of Entries
Data type	UNSIGNED8
Access	read only
PDO mapping	no
Allowed values	
Preset value	02 <sub>h</sub>

Subindex	01 <sub>h</sub>
Name	Fieldbus Module Disable Mask

Data type	UNSIGNED32
Access	read only
PDO mapping	no
Allowed values	
Preset value	00000000 <sub>h</sub>

---

Subindex	02 <sub>h</sub>
Name	Fieldbus Module Enabled
Data type	UNSIGNED32
Access	read only
PDO mapping	no
Allowed values	
Preset value	00000008 <sub>h</sub>

### Description

Subindex 1 (Fieldbus Module Disable Mask): This subindex contains all physical interfaces and protocols that can be activated or deactivated. A value "1" means that this fieldbus can be deactivated.

Subindex 2 (Fieldbus Module Enabled): This subindex contains all currently activated physical interfaces and protocols. The value "1" means that that the fieldbus is active.

The following distribution of the bits applies for subindices 1 and 2:

31	30	29	28	27	26	25	24	23	22	21	20	19	18	17	16
													E-IP	MTCP	MRTU
15	14	13	12	11	10	9	8	7	6	5	4	3	2	1	0
									SPI	E-CAT	E-NET	CAN	RS232	RS485	USB

#### USB

USB interface

#### RS-485

RS-485 interface

#### RS-232

RS-232 interface

#### CAN

CANopen interface

#### E-NET

EtherNet interface

#### E-CAT

EtherCAT interface

#### SPI

SPI interface

#### MRTU

Modbus RTU protocol

**MTCP**

Modbus TCP protocol

**E-IP**

EtherNet/IP™ protocol

**2290h PDI Control****Function**

With this object, you can activate the *Plug&Drive interface*. You can find additional information in document *Function description Plug&Drive interface*.

**Object description**

---

Index	2290 <sub>h</sub>
Object name	PDI Control
Object Code	VARIABLE
Data type	UNSIGNED8
Savable	yes, category: application
Access	read / write
PDO mapping	no
Allowed values	
Preset value	01 <sub>h</sub>
Firmware version	FIR-v1748-B531667
Change history	Firmware version FIR-v1748-B538662: "Access" table entry for subindex 00 changed from "read only" to "read/write".

---

**Description**

To activate the *Plug&Drive interface*, set bit 0 to "1".

**2291h PDI Input****Function**

If you use the *Plug&Drive interface*, you can use this object to select and start the operating mode and set the corresponding target values (target position, speed, etc.). You can find additional information in document *Function description Plug&Drive interface*.

**Object description**

---

Index	2291 <sub>h</sub>
Object name	PDI Input
Object Code	RECORD
Data type	PDI_INPUT
Savable	no
Access	read only
PDO mapping	RX-PDO
Allowed values	

Preset value	
Firmware version	FIR-v1748-B531667
Change history	Firmware version FIR-v2013-B726332: "Savable" entry changed from "yes, category: application" to "no".

---

## Value description

Subindex	00 <sub>h</sub>
Name	Number Of Entries
Data type	UNSIGNED8
Access	read only
PDO mapping	RX-PDO
Allowed values	
Preset value	04 <sub>h</sub>

---

Subindex	01 <sub>h</sub>
Name	PDI Set Value 1
Data type	INTEGER32
Access	read / write
PDO mapping	RX-PDO
Allowed values	
Preset value	00000000 <sub>h</sub>

---

Subindex	02 <sub>h</sub>
Name	PDI Set Value 2
Data type	INTEGER16
Access	read / write
PDO mapping	RX-PDO
Allowed values	
Preset value	0000 <sub>h</sub>

---

Subindex	03 <sub>h</sub>
Name	PDI Set Value 3
Data type	INTEGER8
Access	read / write
PDO mapping	RX-PDO
Allowed values	
Preset value	00 <sub>h</sub>

---

Subindex	04 <sub>h</sub>
Name	PDI Command
Data type	INTEGER8
Access	read / write

PDO mapping	RX-PDO
Allowed values	
Preset value	00 <sub>h</sub>

---

## 2292h PDI Output

### Function

If you use the *Plug&Drive interface*, you can, in this object, read the status and a return value that is dependent on the used operating mode. You can find additional information in document *Function description Plug&Drive interface*.

### Object description

---

Index	2292 <sub>h</sub>
Object name	PDI Output
Object Code	RECORD
Data type	PDI_OUTPUT
Savable	no
Access	read only
PDO mapping	TX-PDO
Allowed values	
Preset value	
Firmware version	FIR-v1748-B531667
Change history	

---

### Value description

---

Subindex	00 <sub>h</sub>
Name	Number Of Entries
Data type	UNSIGNED8
Access	read only
PDO mapping	TX-PDO
Allowed values	
Preset value	02 <sub>h</sub>

---



---

Subindex	01 <sub>h</sub>
Name	PDI Status
Data type	INTEGER16
Access	read only
PDO mapping	TX-PDO
Allowed values	
Preset value	0000 <sub>h</sub>

---



---

Subindex	02 <sub>h</sub>
Name	PDI Return Value

---

Data type	INTEGER32
Access	read only
PDO mapping	TX-PDO
Allowed values	
Preset value	00000000 <sub>h</sub>

## 2300h NanoJ Control

### Function

Controls the execution of a *NanoJ program*.

### Object description

Index	2300 <sub>h</sub>
Object name	NanoJ Control
Object Code	VARIABLE
Data type	UNSIGNED32
Savable	yes, category: application
Access	read / write
PDO mapping	RX-PDO
Allowed values	
Preset value	00000000 <sub>h</sub>
Firmware version	FIR-v1426
Change history	Firmware version FIR-v1436: "Object Name" entry changed from "VMM Control" to "NanoJ Control".

### Description

31	30	29	28	27	26	25	24	23	22	21	20	19	18	17	16
15	14	13	12	11	10	9	8	7	6	5	4	3	2	1	0
													AYield		ON

### ON

Switches the *NanoJ program* on (value = "1") or off (value = "0").

With a rising edge in bit 0, the program is first reloaded and the variable range reset.



#### NOTICE

Startup of the *NanoJ program* can take up to 200 ms.

When switching on, a check is performed to determine whether a *NanoJ program* is present. If present, "1" is entered in 2300 and the *NanoJ program* is started.

**AYield (AutoYield)**

If this feature is activated (bit set to "1"), the *NanoJ program* is no longer stopped if it runs longer than it is allowed to. The *NanoJ program* is, thus, no longer real-time capable and no longer runs every 1 ms (see [Available computing time](#)).



**NOTICE**

Do not use the [Debug output](#) if *AutoYield* mode is activated.

**2301h NanoJ Status**

**Function**

Indicates the operating state of the user program.

**Object description**

---

Index	2301 <sub>h</sub>
Object name	NanoJ Status
Object Code	VARIABLE
Data type	UNSIGNED32
Savable	no
Access	read only
PDO mapping	TX-PDO
Allowed values	
Preset value	00000000 <sub>h</sub>
Firmware version	FIR-v1426
Change history	Firmware version FIR-v1436: "Object Name" entry changed from "VMM Status" to "NanoJ Status".

---

**Description**

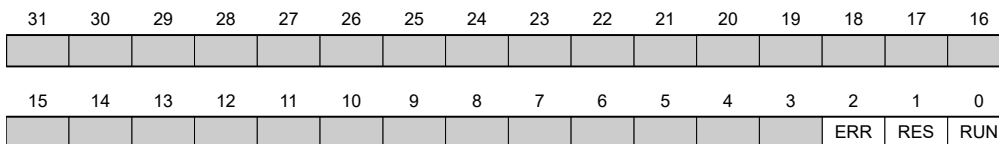

**RUN**

Value = "0": Program is stopped, value = "1": NanoJ program is running.

**RES**

Reserved.

**ERR**

Program was ended with an error. Cause of the error can be read from object [2302<sub>h</sub>](#).

## 2302h NanoJ Error Code

### Function

Indicates which error occurred during the execution of the user program.

### Object description

Index	2302 <sub>h</sub>
Object name	NanoJ Error Code
Object Code	VARIABLE
Data type	UNSIGNED32
Savable	no
Access	read only
PDO mapping	TX-PDO
Allowed values	
Preset value	00000000 <sub>h</sub>
Firmware version	FIR-v1426
Change history	Firmware version FIR-v1436: "Object Name" entry changed from "VMM Error Code" to "NanoJ Error Code".

### Description

Error codes during program execution:

Number	Description
0001 <sub>h</sub>	Firmware does not support the used function (e.g., <code>sin</code> , <code>cosin</code> , etc.)
0005 <sub>h</sub>	Time Out: Code executed too long without <code>yield()</code> or <code>sleep()</code>
0007 <sub>h</sub>	Too many variables on the stack
0100 <sub>h</sub>	Invalid NanoJ program file
0101 <sub>h</sub>	Invalid NanoJ version of the program file
0102 <sub>h</sub>	CRC error in the NanoJ program file

Error when accessing an object:

Number	Description
1xxxxyy <sub>h</sub>	Invalid mapping in the NanoJ program file: The value in "xxxx" specifies the index, the value in "yy" specifies the subindex of the object that should – but cannot – be mapped.
2000000 <sub>h</sub>	Invalid mapping in the NanoJ program file: too many variables of type <code>input</code> were declared (see <a href="#">2310h NanoJ Input Data Selection</a> )
3000000 <sub>h</sub>	Invalid mapping in the NanoJ program file: too many variables of type <code>output</code> were declared (see <a href="#">2320h NanoJ Output Data Selection</a> )
4000000 <sub>h</sub>	Invalid mapping in the NanoJ program file: too many variables of type <code>inout</code> were declared (see <a href="#">2330h NanoJ In/output Data Selection</a> )
1000 <sub>h</sub>	Access of a nonexistent object in the object dictionary
1001 <sub>h</sub>	Write access of a write-protected entry in the OD
1002 <sub>h</sub>	An attempt was made to write a value that is too low or too high to an object.



Number	Description
1003 <sub>h</sub>	An attempt was made to read out an object that permits only write access.
1FFF <sub>h</sub>	Unauthorized access of an object

## 230Eh Timer

### Function

This object contains the operating time in milliseconds since the last time the controller was started.



#### NOTICE

This object is not stored; counting begins with "0" again after switching on or an overflow.

### Object description

Index	230E <sub>h</sub>
Object name	Timer
Object Code	ARRAY
Data type	UNSIGNED32
Savable	no
Access	read only
PDO mapping	no
Allowed values	
Preset value	
Firmware version	FIR-v2139-B1020888
Change history	

### Value description

Subindex	00 <sub>h</sub>
Name	Number Of Entries
Data type	UNSIGNED8
Access	read only
PDO mapping	no
Allowed values	
Preset value	01 <sub>h</sub>
Subindex	01 <sub>h</sub>
Name	1ms Timer
Data type	UNSIGNED32
Access	read only
PDO mapping	no
Allowed values	
Preset value	00000000 <sub>h</sub>

## 230Fh Uptime Seconds

### Function

This object contains the operating time in seconds since the last time the controller was started.



#### NOTICE

This object is not stored; counting begins with "0" again after switching on or an overflow.

### Object description

Index	230F <sub>h</sub>
Object name	Uptime Seconds
Object Code	VARIABLE
Data type	UNSIGNED32
Savable	no
Access	read only
PDO mapping	TX-PDO
Allowed values	
Preset value	00000000 <sub>h</sub>
Firmware version	FIR-v1436
Change history	

## 2310h NanoJ Input Data Selection

### Function

Describes the object dictionary entries that are copied to the PDO mapping input of the NanoJ program.

### Object description

Index	2310 <sub>h</sub>
Object name	NanoJ Input Data Selection
Object Code	ARRAY
Data type	UNSIGNED32
Savable	no
Access	read / write
PDO mapping	no
Allowed values	
Preset value	
Firmware version	FIR-v1650-B472161
Change history	<p>Firmware version FIR-v1436: "Object Name" entry changed from "VMM Input Data Selection" to "NanoJ Input Data Selection".</p> <p>Firmware version FIR-v1650-B472161: "Savable" entry changed from "yes, category: application" to "no".</p> <p>Firmware version FIR-v1650-B472161: "Access" table entry for subindex 00 changed from "read/write" to "read only".</p>

Firmware version FIR-v1650-B472161: "Access" table entry for subindex 01 changed from "read/write" to "read only".

## Value description

Subindex	00 <sub>h</sub>
Name	Number Of Entries
Data type	UNSIGNED8
Access	read only
PDO mapping	no
Allowed values	
Preset value	10 <sub>h</sub>

  

Subindex	01 <sub>h</sub> - 10 <sub>h</sub>
Name	Mapping #1 - #16
Data type	UNSIGNED32
Access	read only
PDO mapping	no
Allowed values	
Preset value	00000000 <sub>h</sub>

## Description

Each subindex (1–16) describes a different mapped object.

A mapping entry consists of four bytes, which are structured according to the following graphic.

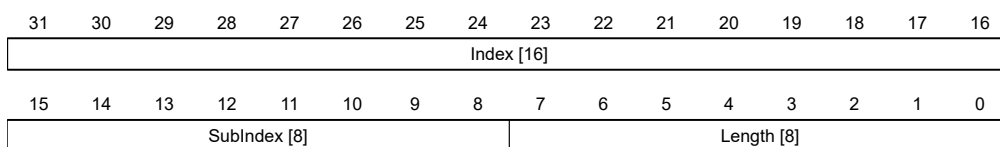

### Index [16]

This contains the index of the object to be mapped

### Subindex [8]

This contains the subindex of the object to be mapped

### Length [8]

This contains the length of the object to be mapped in units of bits.

## 2320h NanoJ Output Data Selection

### Function

Describes the object dictionary entries that are copied into the output PDO mapping of the *NanoJ program* after it is executed.

## Object description

Index	2320 <sub>h</sub>
Object name	NanoJ Output Data Selection
Object Code	ARRAY
Data type	UNSIGNED32
Savable	no
Access	read / write
PDO mapping	no
Allowed values	
Preset value	
Firmware version	FIR-v1650-B472161
Change history	<p>Firmware version FIR-v1436: "Object Name" entry changed from "VMM Output Data Selection" to "NanoJ Output Data Selection".</p> <p>Firmware version FIR-v1650-B472161: "Savable" entry changed from "yes, category: application" to "no".</p> <p>Firmware version FIR-v1650-B472161: "Access" table entry for subindex 00 changed from "read/write" to "read only".</p> <p>Firmware version FIR-v1650-B472161: "Access" table entry for subindex 01 changed from "read/write" to "read only".</p>

## Value description

Subindex	00 <sub>h</sub>
Name	Number Of Entries
Data type	UNSIGNED8
Access	read only
PDO mapping	no
Allowed values	
Preset value	10 <sub>h</sub>
Subindex	01 <sub>h</sub> - 10 <sub>h</sub>
Name	Mapping #1 - #16
Data type	UNSIGNED32
Access	read only
PDO mapping	no
Allowed values	
Preset value	00000000 <sub>h</sub>

## Description

Each subindex (1–16) describes a different mapped object.

A mapping entry consists of four bytes, which are structured according to the following graphic.

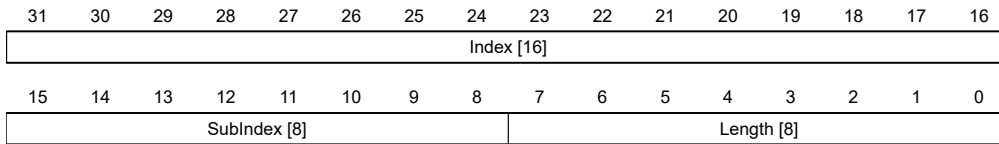

**Index [16]**

This contains the index of the object to be mapped

**Subindex [8]**

This contains the subindex of the object to be mapped

**Length [8]**

This contains the length of the object to be mapped in units of bits.

## 2330h NanoJ In/output Data Selection

### Function

Describes the object dictionary entries that are first copied to the input PDO mapping of the NanoJ program and, after it is executed, are copied back to the output PDO mapping.

### Object description

Index	2330 <sub>h</sub>
Object name	NanoJ In/output Data Selection
Object Code	ARRAY
Data type	UNSIGNED32
Savable	no
Access	read / write
PDO mapping	no
Allowed values	
Preset value	
Firmware version	FIR-v1650-B472161
Change history	<p>Firmware version FIR-v1436: "Object Name" entry changed from "VMM In/output Data Selection" to "NanoJ In/output Data Selection".</p> <p>Firmware version FIR-v1650-B472161: "Savable" entry changed from "yes, category: application" to "no".</p> <p>Firmware version FIR-v1650-B472161: "Access" table entry for subindex 00 changed from "read/write" to "read only".</p> <p>Firmware version FIR-v1650-B472161: "Access" table entry for subindex 01 changed from "read/write" to "read only".</p>

### Value description

Subindex	00 <sub>h</sub>
Name	Number Of Entries
Data type	UNSIGNED8
Access	read only
PDO mapping	no

Allowed values	
Preset value	10 <sub>h</sub>
<hr/>	
Subindex	01 <sub>h</sub> - 10 <sub>h</sub>
Name	Mapping #1 - #16
Data type	UNSIGNED32
Access	read only
PDO mapping	no
Allowed values	
Preset value	00000000 <sub>h</sub>

### Description

Each subindex (1–16) describes a different mapped object.

A mapping entry consists of four bytes, which are structured according to the following graphic.

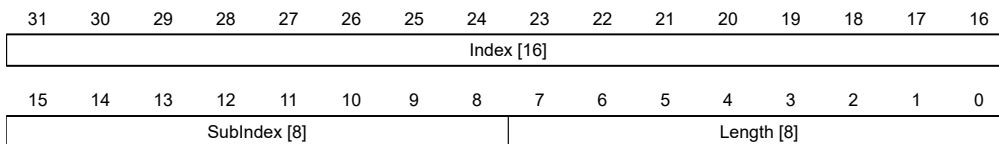

#### Index [16]

This contains the index of the object to be mapped

#### Subindex [8]

This contains the subindex of the object to be mapped

#### Length [8]

This contains the length of the object to be mapped in units of bits.

## 2400h NanoJ Inputs

### Function

Located here is an array with 32, 32-bit integer values that is not used within the firmware and serves only for communicating with the user program via the fieldbus.

### Object description

Index	2400 <sub>h</sub>
Object name	NanoJ Inputs
Object Code	ARRAY
Data type	INTEGER32
Savable	no
Firmware version	FIR-v1426
Change history	The number of entries was changed from 2 to 33  Firmware version FIR-v1436: "Object Name" entry changed from "VMM Inputs" to "NanoJ Inputs".

Firmware version FIR-v1436: "Name" entry changed from "VMM Input N#" to "NanoJ Input N#".

## Value description

Subindex	00 <sub>h</sub>
Name	Number Of Entries
Data type	UNSIGNED8
Access	read only
PDO mapping	no
Allowed values	
Preset value	20 <sub>h</sub>
Subindex	01 <sub>h</sub> - 20 <sub>h</sub>
Name	NanoJ Input #1 - #32
Data type	INTEGER32
Access	read / write
PDO mapping	RX-PDO
Allowed values	
Preset value	00000000 <sub>h</sub>

## Description

Here, it is possible to pass, e.g., preset values, to the *NanoJ program*.

## 2410h NanoJ Init Parameters

### Function

This object functions identically to object 2400<sub>h</sub> with the difference that this object can be stored.

### Object description

Index	2410 <sub>h</sub>
Object name	NanoJ Init Parameters
Object Code	ARRAY
Data type	INTEGER32
Savable	yes, category: application
Access	read only
PDO mapping	no
Allowed values	
Preset value	
Firmware version	FIR-v1450
Change history	Firmware version FIR-v1450: "Data Type" entry changed from "INTEGER32" to "UNSIGNED8".

## Value description

Subindex	00 <sub>h</sub>
Name	Number Of Entries
Data type	UNSIGNED8
Access	read only
PDO mapping	no
Allowed values	
Preset value	20 <sub>h</sub>

Subindex	01 <sub>h</sub> - 20 <sub>h</sub>
Name	NanoJ Init Parameter #1 - #32
Data type	INTEGER32
Access	read / write
PDO mapping	RX-PDO
Allowed values	
Preset value	00000000 <sub>h</sub>

## 2500h NanoJ Outputs

### Function

Located here is an array with 32, 32-bit integer values that is not used within the firmware and serves only for communicating with the user program via the fieldbus.

### Object description

Index	2500 <sub>h</sub>
Object name	NanoJ Outputs
Object Code	ARRAY
Data type	INTEGER32
Savable	no
Firmware version	FIR-v1426
Change history	<p>Firmware version FIR-v1436: "Object Name" entry changed from "VMM Outputs" to "NanoJ Outputs".</p> <p>Firmware version FIR-v1436: "Name" entry changed from "VMM Output N#" to "NanoJ Output N#".</p>

## Value description

Subindex	00 <sub>h</sub>
Name	Number Of Entries
Data type	UNSIGNED8
Access	read only
PDO mapping	no
Allowed values	



Preset value	20 <sub>h</sub>
Subindex	01 <sub>h</sub> - 20 <sub>h</sub>
Name	NanoJ Output #1 - #32
Data type	INTEGER32
Access	read / write
PDO mapping	TX-PDO
Allowed values	
Preset value	00000000 <sub>h</sub>

## Description

Here, the *NanoJ program* can store results which can then be read out via the fieldbus.

## 2600h NanoJ Debug Output

### Function

This object contains debug output of a user program.

### Object description

Index	2600 <sub>h</sub>
Object name	NanoJ Debug Output
Object Code	ARRAY
Data type	UNSIGNED8
Savable	no
Firmware version	FIR-v1426
Change history	Firmware version FIR-v1436: "Object Name" entry changed from "VMM Debug Output" to "NanoJ Debug Output".

### Value description

Subindex	00 <sub>h</sub>
Name	Number Of Entries
Data type	UNSIGNED8
Access	read / write
PDO mapping	no
Allowed values	
Preset value	00 <sub>h</sub>
Subindex	01 <sub>h</sub> - 40 <sub>h</sub>
Name	Value #1 - #64
Data type	UNSIGNED8
Access	read only
PDO mapping	no

Allowed values

Preset value 00<sub>h</sub>

## Description

Here, the NanoJ program stores the debug output that was called up with the `VmmDebugOutputString()` and `VmmDebugOutputInt()`.

## 2701h Customer Storage Area

### Function

Data can be deposited and stored in this object.

### Object description

Index	2701 <sub>h</sub>
Object name	Customer Storage Area
Object Code	ARRAY
Data type	UNSIGNED32
Savable	yes, category: customer
Access	read only
PDO mapping	no
Allowed values	
Preset value	
Firmware version	FIR-v1540
Change history	Firmware version FIR-v1540: "Data Type" entry changed from "UNSIGNED32" to "UNSIGNED8".

### Value description

Subindex	00 <sub>h</sub>
Name	Number Of Entries
Data type	UNSIGNED8
Access	read only
PDO mapping	no
Allowed values	
Preset value	FE <sub>h</sub>

Subindex	01 <sub>h</sub> - FE <sub>h</sub>
Name	Storage #1 - #254
Data type	UNSIGNED32
Access	read / write
PDO mapping	no
Allowed values	
Preset value	00000000 <sub>h</sub>

## 2800h Bootloader And Reboot Settings

### Function

With this object, a reboot of the firmware can be triggered and the short circuiting of the motor windings in boot loader mode switched off and on.

### Object description

Index	2800 <sub>h</sub>
Object name	Bootloader And Reboot Settings
Object Code	ARRAY
Data type	UNSIGNED32
Savable	yes, category: application
Access	read only
PDO mapping	no
Allowed values	
Preset value	
Firmware version	FIR-v1540
Change history	

### Value description

Subindex	00 <sub>h</sub>
Name	Number Of Entries
Data type	UNSIGNED8
Access	read only
PDO mapping	no
Allowed values	
Preset value	03 <sub>h</sub>

Subindex	01 <sub>h</sub>
Name	Reboot Command
Data type	UNSIGNED32
Access	read / write
PDO mapping	no
Allowed values	
Preset value	00000000 <sub>h</sub>

Subindex	02 <sub>h</sub>
Name	Reboot Delay Time In Ms
Data type	UNSIGNED32
Access	read / write
PDO mapping	no
Allowed values	
Preset value	00000000 <sub>h</sub>

Subindex	03 <sub>h</sub>
Name	Bootloader HW Config
Data type	UNSIGNED32
Access	read / write
PDO mapping	no
Allowed values	
Preset value	00000000 <sub>h</sub>

### Description

The subindices have the following function:

- 01<sub>h</sub>: If the value "746F6F62<sub>h</sub>" is entered here, the firmware is rebooted.
- 02<sub>h</sub>: Time in milliseconds: delays the reboot of the firmware by the respective time.
- 03<sub>h</sub>: Bit 0 can be used to switch short circuiting of the motor windings in boot loader mode off and on:
  - Bit 0 = 1: Short circuiting of the motor windings in boot loader mode is switched off.
  - Bit 0 = 0: Short circuiting of the motor windings in boot loader mode is switched on.

### 3202h Motor Drive Submode Select

#### Function

Controls the controller mode, such as the changeover between *closed loop / open loop* and whether Velocity Mode is simulated via the S-controller or functions with a real V-controller in *closed loop*.

#### Object description

Index	3202 <sub>h</sub>
Object name	Motor Drive Submode Select
Object Code	VARIABLE
Data type	UNSIGNED32
Savable	yes, category: drive
Access	read / write
PDO mapping	RX-PDO
Allowed values	
Preset value	00000000 <sub>h</sub>
Firmware version	FIR-v1426
Change history	<p>Firmware version FIR-v1540: "Savable" entry changed from "yes category: application" to "yes, category: travel".</p> <p>Firmware version FIR-v1540: "Savable" entry changed from "yes category: travel" to "yes, category: movement".</p>

### Description



## CL/OL

Changeover between *open loop* and *closed loop* (see chapter [Control modes](#))

- Value = "0": *open loop*
- Value = "1": *closed loop*

Toggling is not possible in the *Operation enabled* state.

## VoS

Value = "1": Simulate V-controller with an S-ramp: simulate the speed modes through continuous position changes

## Brake

Value = "1": Switch on automatic brake control.

## CurRed (Current Reduction)

Value = "1": Current reduction activated in *open loop*

## AutoAI ( *auto alignment* )

For the case that operation in *closed loop* is required (bit 0 in 3202<sub>h</sub> is set).

Value = "1": The *auto alignment* process is activated; immediately after switching on, an alignment is determined in *open loop* and a switch is immediately made to *closed loop* mode without the encoder index having been seen.

The rotor is moved slightly during this process.

Value = "0": No *auto alignment*, the motor operates in *open loop* until the encoder index is seen (maximum one revolution of the motor shaft).

If the incremental encoder used for commutation does not have an index (bit 0 in 33A0<sub>h</sub> is "0"), an *auto alignment* is always determined.

## Torque

only active in operating modes [Profile Torque](#) and [Cyclic Synchronous Torque](#)

Value = "1": M-controller is active, otherwise a V-controller is superimposed: no V-controller is used in the torque modes for speed limiting, thus object 6080<sub>h</sub> is ignored; 3210<sub>h</sub>:3 and 3210<sub>h</sub>:4 have no effect on the control.

## BLDC

Value = "1": Motor type "BLDC" (brushless DC motor)

## Slow ( *slow speed* )

Value = "1": The slow speed mode is activated ( *closed loop* must already be activated)

## 3203h Feedback Selection

### Function

In this object, the sources of the presets are defined for the commutation and the velocity and position control.

A value change in the *Operation enabled* state shows no immediate effect. Value changes in objects are buffered and read out upon changing to the *Operation enabled* state.

## Object description

Index	3203 <sub>h</sub>
Object name	Feedback Selection
Object Code	ARRAY
Data type	UNSIGNED8
Savable	yes, category: tuning
Access	read only
PDO mapping	RX-PDO
Allowed values	
Preset value	
Firmware version	FIR-v1748-B538662
Change history	

## Value description

Subindex	00 <sub>h</sub>
Name	Number Of Entries
Data type	UNSIGNED8
Access	read only
PDO mapping	RX-PDO
Allowed values	
Preset value	04 <sub>h</sub>

Subindex	01 <sub>h</sub>
Name	1st Feedback Interface
Data type	UNSIGNED8
Access	read / write
PDO mapping	RX-PDO
Allowed values	
Preset value	00 <sub>h</sub>

Subindex	02 <sub>h</sub>
Name	2nd Feedback Interface
Data type	UNSIGNED8
Access	read / write
PDO mapping	RX-PDO
Allowed values	
Preset value	00 <sub>h</sub>

Subindex	03 <sub>h</sub>
Name	3rd Feedback Interface
Data type	UNSIGNED8
Access	read / write

PDO mapping	RX-PDO
Allowed values	
Preset value	00 <sub>h</sub>

Subindex	04 <sub>h</sub>
Name	4th Feedback Interface
Data type	UNSIGNED8
Access	read / write
PDO mapping	RX-PDO
Allowed values	
Preset value	00 <sub>h</sub>

## Description

The subindices have the following function:

- 00<sub>h</sub>: Value="1" to "n", where "n" is the number of existing feedbacks.
- n<sub>h</sub>:  
Subindex n contains a bit mask for the respective feedback n. The bits have the following meaning here:
  - Bit 0: If the bit is set to "1", this sensor is used for position feedback.
  - Bit 1: If the bit is set to "1", this sensor is used for velocity feedback.
  - Bit 2: If the bit is set to "1", this sensor is used for commutation feedback in [Closed-Loop](#).

Subindex 01<sub>h</sub> always corresponds to the first (and always existing) *sensorless* feedback. The order of the remaining feedbacks corresponds to the table in chapter [Configuring the sensors](#).

Which sensor the controller takes into account for the individual controllers (commutation, velocity, position) is implicitly specified by the order of the sensors.

The search always begins with sensor 2 and continues in ascending order until all existing sensors have been queried. If a sensor is found whose feedback is set, it is assigned to the corresponding controller and the search ended.

### NOTICE



If bit 0 in 3202<sub>h</sub> is set to "0", *closed loop* is deactivated; bit 2 (commutation) then has no meaning. Bit 1 for the velocity and bit 0 for the position in the respective subindices are still used for the display of the actual position and speed values.

## 3204h Feedback Mapping

### Function

This object contains information on the existing feedbacks.

### Object description

Index	3204 <sub>h</sub>
Object name	Feedback Mapping
Object Code	ARRAY
Data type	UNSIGNED16
Savable	no

Access	read only
PDO mapping	TX-PDO
Allowed values	
Preset value	
Firmware version	FIR-v1748-B538662
Change history	

---

## Value description

Subindex	00 <sub>h</sub>
Name	Number Of Entries
Data type	UNSIGNED8
Access	read only
PDO mapping	TX-PDO
Allowed values	
Preset value	04 <sub>h</sub>

---

Subindex	01 <sub>h</sub>
Name	Index Of 1st Feedback Interface
Data type	UNSIGNED16
Access	read only
PDO mapping	TX-PDO
Allowed values	
Preset value	3380 <sub>h</sub>

---

Subindex	02 <sub>h</sub>
Name	Index Of 2nd Feedback Interface
Data type	UNSIGNED16
Access	read only
PDO mapping	TX-PDO
Allowed values	
Preset value	3390 <sub>h</sub>

---

Subindex	03 <sub>h</sub>
Name	Index Of 3rd Feedback Interface
Data type	UNSIGNED16
Access	read only
PDO mapping	TX-PDO
Allowed values	
Preset value	33A0 <sub>h</sub>

---

Subindex	04 <sub>h</sub>
Name	Index Of 4th Feedback Interface



Data type	UNSIGNED16
Access	read only
PDO mapping	TX-PDO
Allowed values	
Preset value	33A1 <sub>h</sub>

---

## Description

The subindices have the following function:

- 00<sub>h</sub>: Value="1" to "n", where "n" is the number of existing feedbacks.
- n<sub>h</sub>:  
 Subindex n refers to the index of the respective object for the configuration of the corresponding feedback.  
 Subindex 01<sub>h</sub> always corresponds to the first (and always existing) *sensorless* feedback. The order of the remaining feedbacks corresponds to the table in chapter [Configuring the sensors](#).

## 320Dh Torque Of Inertia Factor

### Function

This factor is used for calculating the acceleration feed forward (see [321D](#)). Default is 0 (feed forward inactive).

Acceleration feed forward applies during deceleration as well.

### Object description

---

Index	320D <sub>h</sub>
Object name	Torque Of Inertia Factor
Object Code	ARRAY
Data type	UNSIGNED32
Savable	yes, category: drive
Access	read only
PDO mapping	no
Allowed values	
Preset value	
Firmware version	FIR-v1825-B577172
Change history	

---

### Value description

---

Subindex	00 <sub>h</sub>
Name	Number Of Entries
Data type	UNSIGNED8
Access	read only
PDO mapping	no
Allowed values	
Preset value	02 <sub>h</sub>

---

Subindex	01 <sub>h</sub>
Name	Current
Data type	UNSIGNED32
Access	read / write
PDO mapping	no
Allowed values	
Preset value	00000000 <sub>h</sub>

Subindex	02 <sub>h</sub>
Name	Acceleration
Data type	UNSIGNED32
Access	read / write
PDO mapping	no
Allowed values	
Preset value	00000000 <sub>h</sub>

## Description

The value is dependent on the inertia of the load. To determine the factor:

1. Activate *closed loop* and select the *profile torque* mode.
2. Set a target for the torque and enter the corresponding current value (mA) in 320D<sub>h</sub>:01<sub>h</sub>.
3. Record (e. g., in *Plug & Drive Studio*) the current speed (object 606C<sub>h</sub>). Calculate the acceleration in the set *user-defined units* for the speed range, where this is constant. Enter the value in 320D<sub>h</sub>:02<sub>h</sub>.  
Using the speed curve in the following figure as an example:  
 $(90-50)/(1200-980)=182$  rpm/s.

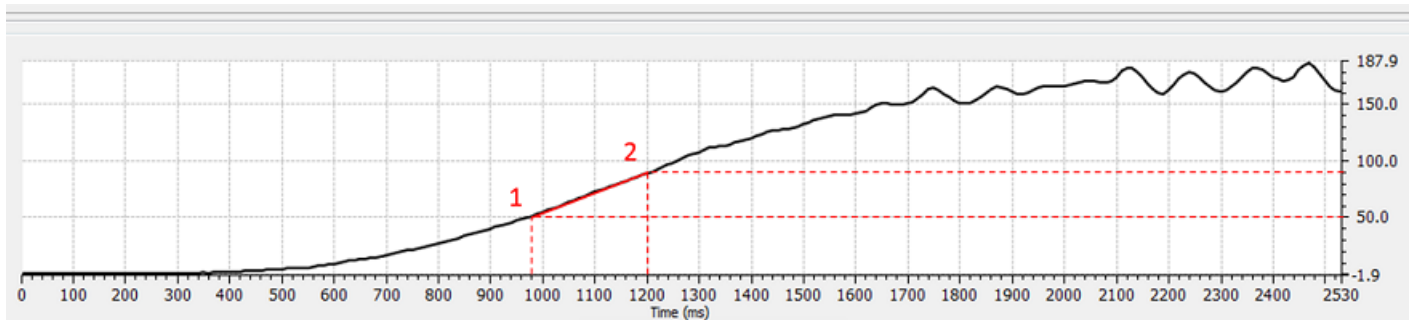

## 3210h Motor Drive Parameter Set

### Function

Contains the P and I components of the current, speed and position controllers for *open-loop* (only current controller activated) and *closed-loop*.

#### NOTICE

For firmware versions from FIR-v22xx upwards, the new schema for the *Controller structure* applies.



The old control parameters (object 3210<sub>h</sub>) are activated in the factory settings for compatibility reasons. Object 320E<sub>h</sub> used in firmware versions FIR-v19xx to FIR-v21xx has been removed. For new applications, Nanotec recommends using the new control parameters.

To use the new parameters, set 3212<sub>h</sub>:04<sub>h</sub> to "1". The old values are converted and entered in the new objects 321A<sub>h</sub> to 321E<sub>h</sub>. You must save all objects (see *Saving objects*).

## Object description

Index	3210 <sub>h</sub>
Object name	Motor Drive Parameter Set
Object Code	ARRAY
Data type	UNSIGNED32
Savable	yes, category: application
Access	read only
PDO mapping	RX-PDO
Allowed values	
Preset value	
Firmware version	FIR-v1426
Change history	<p>Firmware version FIR-v1626: "Name" entry changed from "S_P" to "Position Loop, Proportional Gain (closed-loop)".</p> <p>Firmware version FIR-v1626: "Name" entry changed from "S_I" to "Position Loop, Integral Gain (closed-loop)".</p> <p>Firmware version FIR-v1626: "Name" entry changed from "V_P" to "Velocity Loop, Proportional Gain (closed-loop)".</p> <p>Firmware version FIR-v1626: "Name" entry changed from "V_I" to "Velocity Loop, Integral Gain (closed-loop)".</p> <p>Firmware version FIR-v1626: "Name" entry changed from "Id_P" to "Flux Current Loop, Proportional Gain (closed-loop)".</p> <p>Firmware version FIR-v1626: "Name" entry changed from "Id_I" to "Flux Current Loop, Integral Gain (closed-loop)".</p> <p>Firmware version FIR-v1626: "Name" entry changed from "Iq_P" to "Torque Current Loop, Proportional Gain (closed-loop)".</p> <p>Firmware version FIR-v1626: "Name" entry changed from "Iq_I" to "Torque Current Loop, Integral Gain (closed-loop)".</p> <p>Firmware version FIR-v1626: "Name" entry changed from "I_P" to "Torque Current Loop, Proportional Gain (dspDrive – Stepper Motor, open-loop)".</p> <p>Firmware version FIR-v1626: "Name" entry changed from "I_I" to "Torque Current Loop, Integral Gain (dspDrive – Stepper Motor, open-loop)".</p> <p>Firmware version FIR-v1650-B472161: "Name" entry changed from "Torque Current Loop, Proportional Gain (dspDrive – Stepper Motor, open-loop)" to "Torque Current Loop, Proportional Gain (open-loop)".</p> <p>Firmware version FIR-v1650-B472161: "Name" entry changed from "Torque Current Loop, Integral Gain (dspDrive – Stepper Motor, open-loop)" to "Torque Current Loop, Integral Gain (open-loop)".</p> <p>Firmware version FIR-v1650-B472161: "Data type" entry changed from "INTEGER32" to "UNSIGNED32".</p> <p>Firmware version FIR-v1650-B472161: "Data type" entry changed from "INTEGER32" to "UNSIGNED32".</p> <p>Firmware version FIR-v1738-B501312: The number of entries was changed from 11 to 13.</p>

Firmware version FIR-v1738-B501312: "PDO mapping" table entry for subindex 00 to 0A changed from "no" to "RX-PDO".

## Value description

Subindex	00 <sub>h</sub>
Name	Number Of Entries
Data type	UNSIGNED8
Access	read only
PDO mapping	RX-PDO
Allowed values	
Preset value	0C <sub>h</sub>

Subindex	01 <sub>h</sub>
Name	Position Loop, Proportional Gain (closed Loop)
Data type	UNSIGNED32
Access	read / write
PDO mapping	RX-PDO
Allowed values	
Preset value	00000800 <sub>h</sub>

Subindex	02 <sub>h</sub>
Name	Position Loop, Integral Gain (closed Loop)
Data type	UNSIGNED32
Access	read / write
PDO mapping	RX-PDO
Allowed values	
Preset value	00000000 <sub>h</sub>

Subindex	03 <sub>h</sub>
Name	Velocity Loop, Proportional Gain (closed Loop)
Data type	UNSIGNED32
Access	read / write
PDO mapping	RX-PDO
Allowed values	
Preset value	00002EE0 <sub>h</sub>

Subindex	04 <sub>h</sub>
Name	Velocity Loop, Integral Gain (closed Loop)
Data type	UNSIGNED32
Access	read / write
PDO mapping	RX-PDO
Allowed values	

Preset value	000001E <sub>h</sub>
Subindex	05 <sub>h</sub>
Name	Flux Current Loop, Proportional Gain (closed Loop)
Data type	UNSIGNED32
Access	read / write
PDO mapping	RX-PDO
Allowed values	
Preset value	00881EE0 <sub>h</sub>
Subindex	06 <sub>h</sub>
Name	Flux Current Loop, Integral Gain (closed Loop)
Data type	UNSIGNED32
Access	read / write
PDO mapping	RX-PDO
Allowed values	
Preset value	0007C740 <sub>h</sub>
Subindex	07 <sub>h</sub>
Name	Torque Current Loop, Proportional Gain (closed Loop)
Data type	UNSIGNED32
Access	read / write
PDO mapping	RX-PDO
Allowed values	
Preset value	00881EE0 <sub>h</sub>
Subindex	08 <sub>h</sub>
Name	Torque Current Loop, Integral Gain (closed Loop)
Data type	UNSIGNED32
Access	read / write
PDO mapping	RX-PDO
Allowed values	
Preset value	0007C740 <sub>h</sub>
Subindex	09 <sub>h</sub>
Name	Torque Current Loop, Proportional Gain (open Loop)
Data type	UNSIGNED32
Access	read / write
PDO mapping	RX-PDO
Allowed values	
Preset value	004DC880 <sub>h</sub>
Subindex	0A <sub>h</sub>

Name	Torque Current Loop, Integral Gain (open Loop)
Data type	UNSIGNED32
Access	read / write
PDO mapping	RX-PDO
Allowed values	
Preset value	001D2B30 <sub>h</sub>
<hr/>	
Subindex	0B <sub>h</sub>
Name	Velocity Feed Forward Factor In Per Mille
Data type	UNSIGNED32
Access	read / write
PDO mapping	RX-PDO
Allowed values	
Preset value	000003E8 <sub>h</sub>
<hr/>	
Subindex	0C <sub>h</sub>
Name	Acceleration Feed Forward Factor
Data type	UNSIGNED32
Access	read / write
PDO mapping	RX-PDO
Allowed values	
Preset value	00000000 <sub>h</sub>

## Description

- Subindex 00<sub>h</sub>: Number of entries
- Subindex 01<sub>h</sub>: Proportional component of the S-controller (position)
- Subindex 02<sub>h</sub>: Integral component of the S-controller (position)
- Subindex 03<sub>h</sub>: Proportional component of the V-controller (speed)
- Subindex 04<sub>h</sub>: Integral component of the V-controller (speed)
- Subindex 05<sub>h</sub>: (Closed loop) Proportional component of the current controller of the field-forming component
- Subindex 06<sub>h</sub>: (Closed loop) Integral component of the current controller of the field-forming component
- Subindex 07<sub>h</sub>: (Closed loop) Proportional component of the current controller of the torque-forming component
- Subindex 08<sub>h</sub>: (Closed loop) Integral component of the current controller of the torque-forming component
- Subindex 09<sub>h</sub>: (Open-loop) Proportional component of the current controller of the field-building component
- Subindex 0A<sub>h</sub>: (Open-loop) Integral component of the current controller of the field-forming component
- Subindex 0B<sub>h</sub>: (Closed loop) Speed feed forward in tenths of a percent. Default is 1000 and, thus, a factor of 1.
- Subindex 0C<sub>h</sub>: (Closed loop) Acceleration feed forward. Default is 0 (feed forward inactive). It applies during deceleration as well.

## 3212h Motor Drive Flags

### Function

This object is used to specify whether or not auto setup is to adapt the controller parameters. The direction of the rotating field can also be changed.

#### NOTICE



Changes in subindex 02<sub>h</sub> do not take effect until after the controller is restarted. Afterwards, Auto setup must again be performed.

### Object description

Index	3212 <sub>h</sub>
Object name	Motor Drive Flags
Object Code	ARRAY
Data type	INTEGER8
Savable	yes, category: application
Access	read only
PDO mapping	no
Allowed values	
Preset value	
Firmware version	FIR-v1450
Change history	Firmware version FIR-v1512: The number of entries was changed from 2 to 3.  Firmware version FIR-v1738-B501312: "Name" entry changed from "Enable Legacy Power Mode" to "Reserved".

### Value description

Subindex	00 <sub>h</sub>
Name	Number Of Entries
Data type	UNSIGNED8
Access	read only
PDO mapping	no
Allowed values	
Preset value	04 <sub>h</sub>
Subindex	01 <sub>h</sub>
Name	Reserved
Data type	INTEGER8
Access	read / write
PDO mapping	no
Allowed values	
Preset value	00 <sub>h</sub>

---

Subindex	02 <sub>h</sub>
Name	Override Field Inversion
Data type	INTEGER8
Access	read / write
PDO mapping	no
Allowed values	
Preset value	00 <sub>h</sub>

---



---

Subindex	03 <sub>h</sub>
Name	Auto-setup With Current Controller Parameters From The OD
Data type	INTEGER8
Access	read / write
PDO mapping	no
Allowed values	
Preset value	00 <sub>h</sub>

---



---

Subindex	04 <sub>h</sub>
Name	Use 321Ah, 321Bh, 321Ch, 321Dh, Instead Of 3210h
Data type	INTEGER8
Access	read / write
PDO mapping	no
Allowed values	
Preset value	00 <sub>h</sub>

---

## Description

Valid values for subindex 02<sub>h</sub>:

- Value = "0": Use default values of the firmware
- Value = "1": Force non-inversion of the rotating field (mathematically positive)
- Value = "-1": Force inversion of the rotating field (mathematically negative)

Valid values for subindex 03<sub>h</sub>:

- Value = "0": Auto setup detects the motor type (stepper motor or BLDC motor) and uses the corresponding pre-configured parameter set.
- Value = "1": Perform auto setup with the values for the controller that were entered in object 3210<sub>h</sub> or 320E<sub>h</sub> before the auto setup; the values in 3210<sub>h</sub> or 320E<sub>h</sub> are not changed.

## 321Ah Current Controller Parameters

### Function

Contains the parameters for the current controller (commutation). As a rule, the values for I<sub>q</sub> (subindex 01<sub>h</sub>/02<sub>h</sub>) and I<sub>d</sub> (subindex 03<sub>h</sub>/04<sub>h</sub>) should be the same. See chapter Controller structure.

### Object description

---

Index	321A <sub>h</sub>
Object name	Current Controller Parameters



Object Code	ARRAY
Data type	UNSIGNED32
Savable	yes, category: application
Access	read only
PDO mapping	no
Allowed values	
Preset value	
Firmware version	FIR-v2213-B1028181
Change history	

---

## Value description

Subindex	00 <sub>h</sub>
Name	Number Of Entries
Data type	UNSIGNED8
Access	read only
PDO mapping	no
Allowed values	
Preset value	04 <sub>h</sub>

---

Subindex	01 <sub>h</sub>
Name	Proportional Gain Kp For Iq [mV/A]
Data type	UNSIGNED32
Access	read / write
PDO mapping	no
Allowed values	
Preset value	000027E4 <sub>h</sub>

---

Subindex	02 <sub>h</sub>
Name	Integrator Time Ti For Iq [μs]
Data type	UNSIGNED32
Access	read / write
PDO mapping	no
Allowed values	
Preset value	00000446 <sub>h</sub>

---

Subindex	03 <sub>h</sub>
Name	Proportional Gain Kp For Id [mV/A]
Data type	UNSIGNED32
Access	read / write
PDO mapping	no
Allowed values	
Preset value	000027E4 <sub>h</sub>

---

Subindex	04 <sub>h</sub>
Name	Integrator Time T <sub>i</sub> For Id [μs]
Data type	UNSIGNED32
Access	read / write
PDO mapping	no
Allowed values	
Preset value	00000446 <sub>h</sub>

## 321Bh Velocity Controller Parameters

### Function

Contains the parameters for the velocity controller. See chapter [Controller structure](#).

### Object description

Index	321B <sub>h</sub>
Object name	Velocity Controller Parameters
Object Code	ARRAY
Data type	UNSIGNED32
Savable	yes, category: application
Access	read only
PDO mapping	no
Allowed values	
Preset value	
Firmware version	FIR-v2213-B1028181
Change history	

### Value description

Subindex	00 <sub>h</sub>
Name	Number Of Entries
Data type	UNSIGNED8
Access	read only
PDO mapping	no
Allowed values	
Preset value	02 <sub>h</sub>

Subindex	01 <sub>h</sub>
Name	Proportional Gain K <sub>p</sub> [mA/Hz]
Data type	UNSIGNED32
Access	read / write
PDO mapping	no
Allowed values	
Preset value	00000180 <sub>h</sub>

Subindex	02 <sub>h</sub>
Name	Integrator Time T <sub>i</sub> [μs]
Data type	UNSIGNED32
Access	read / write
PDO mapping	no
Allowed values	
Preset value	000186A0 <sub>h</sub>

## 321Ch Position Controller Parameters

### Function

Contains the parameters for the position controller. See chapter [Controller structure](#).

### Object description

Index	321C <sub>h</sub>
Object name	Position Controller Parameters
Object Code	ARRAY
Data type	UNSIGNED32
Savable	yes, category: application
Access	read only
PDO mapping	no
Allowed values	
Preset value	
Firmware version	FIR-v2213-B1028181
Change history	

### Value description

Subindex	00 <sub>h</sub>
Name	Number Of Entries
Data type	UNSIGNED8
Access	read only
PDO mapping	no
Allowed values	
Preset value	02 <sub>h</sub>

Subindex	01 <sub>h</sub>
Name	Proportional Gain K <sub>p</sub> [Hz]
Data type	UNSIGNED32
Access	read / write
PDO mapping	no
Allowed values	
Preset value	00000032 <sub>h</sub>

Subindex	02 <sub>h</sub>
Name	Integrator Time T <sub>i</sub> [μs]
Data type	UNSIGNED32
Access	read / write
PDO mapping	no
Allowed values	
Preset value	00000000 <sub>h</sub>

## 321Dh Pre-control

### Function

Contains the parameters for the feed forward. See chapter [Controller structure](#).

### Object description

Index	321D <sub>h</sub>
Object name	Pre-control
Object Code	ARRAY
Data type	UNSIGNED32
Savable	yes, category: application
Access	read only
PDO mapping	no
Allowed values	
Preset value	
Firmware version	FIR-v2213-B1028181
Change history	

### Value description

Subindex	00 <sub>h</sub>
Name	Number Of Entries
Data type	UNSIGNED8
Access	read only
PDO mapping	no
Allowed values	
Preset value	03 <sub>h</sub>

Subindex	01 <sub>h</sub>
Name	Voltage Pre-control [%]
Data type	UNSIGNED32
Access	read / write
PDO mapping	no
Allowed values	
Preset value	000003E8 <sub>h</sub>

Subindex	02 <sub>h</sub>
Name	Acceleration Pre-control [%]
Data type	UNSIGNED32
Access	read / write
PDO mapping	no
Allowed values	
Preset value	000003E8 <sub>h</sub>

Subindex	03 <sub>h</sub>
Name	Velocity Pre-control [%]
Data type	UNSIGNED32
Access	read / write
PDO mapping	no
Allowed values	
Preset value	000003E8 <sub>h</sub>

## 321Eh Voltage Limit

### Function

Maximum permissible PWM voltage (duty cycle). Values  $\leq 1000$  are interpreted as per mil values (of the available voltage). Values  $> 1000$  as millivolt. See also chapter [Controller structure](#).

### Object description

Index	321E <sub>h</sub>
Object name	Voltage Limit
Object Code	VARIABLE
Data type	UNSIGNED32
Savable	yes, category: application
Access	read / write
PDO mapping	no
Allowed values	
Preset value	000186A0 <sub>h</sub>
Firmware version	FIR-v2213-B1028181
Change history	

### Description

Also dependent on this value is whether the *overmodulation* of the voltage vector is used. If *overmodulation* is used, a higher torque can be achieved. The resulting voltage is no longer sinusoidal, which can result in harmonics and higher losses.

Value in mV	Overmodulation
1001...U <sub>o_low</sub>	None; the voltage vector describes a circle.
U <sub>o_low</sub> ...U <sub>o_high</sub>	The voltage vector describes a circle that is increasingly flattened on four/six sides in proportion to the set value.
$\geq$ U <sub>o_high</sub>	Full; the voltage vector describes a square or a hexagon.

**U<sub>o\_low</sub>**

The lowest voltage above which overmodulation occurs. Is calculated as follows:

Operating voltage\*0.9425

**U<sub>o\_high</sub>**

The maximum overmodulation occurs above this voltage. Is calculated as follows:

With two-phase stepper motors: operating voltage\*1.063

With three-phase BLDC motors: operating voltage\*0.99

## 3220h Analog Input Digits

### Function

Displays the instantaneous values of the analog inputs in *ADC digits*.

With object 3221<sub>h</sub>, the respective analog input can be configured as current or voltage input.

### Object description

Index	3220 <sub>h</sub>
Object name	Analog Input Digits
Object Code	ARRAY
Data type	INTEGER16
Savable	no
Access	read only
PDO mapping	no
Allowed values	
Preset value	
Firmware version	FIR-v1426
Change history	

### Value description

Subindex	00 <sub>h</sub>
Name	Number Of Analog Input Digits
Data type	UNSIGNED8
Access	read only
PDO mapping	no
Allowed values	
Preset value	02 <sub>h</sub>

Subindex	01 <sub>h</sub> - 02 <sub>h</sub>
Name	Analog Input #1 - #2
Data type	INTEGER16
Access	read only
PDO mapping	TX-PDO
Allowed values	

Preset value	0000 <sub>h</sub>
--------------	-------------------

## Description

Formulas for converting from [digits] to the respective unit:

- Voltage input: x digits \* 3.3 V / 1023 digits
- Current input (if configurable): x digits \* 20 mA / 1023 digits

## 3225h Analog Input Switches

### Function

This object contains the value of the virtual rotary switch that is used to configure the address of the controller . The switch position is only read during a restart one time.

### Object description

Index	3225 <sub>h</sub>
Object name	Analog Input Switches
Object Code	ARRAY
Data type	UNSIGNED16
Savable	no
Access	read only
PDO mapping	no
Allowed values	
Preset value	
Firmware version	FIR-v1436
Change history	Firmware version FIR-v1436: "PDO mapping" table entry for subindex 01 changed from "RX-PDO" to "TX-PDO".

### Value description

Subindex	00 <sub>h</sub>
Name	Number Of Entries
Data type	UNSIGNED8
Access	read only
PDO mapping	no
Allowed values	
Preset value	01 <sub>h</sub>

Subindex	01 <sub>h</sub>
Name	Analog Input Switch #1
Data type	UNSIGNED16
Access	read only
PDO mapping	TX-PDO
Allowed values	
Preset value	0000 <sub>h</sub>

## Description

If the controller is equipped with a rotary switch, the value of the rotary switch is displayed in subindex 01<sub>h</sub>. If the controller is equipped with two rotary switches, the value of the rotary switch is displayed in subindex 01<sub>h</sub>, which consists of switch 1 and 2.

## 3231h Flex IO Configuration

### Function

Defines how the pins (inputs/outputs 1 ... 4) of the device are used.

Each bit in the respective subindex corresponds to a pin, whereby the first pin configures DIO1, the second pin DIO2, etc.

- Pin 1: DIO1\_IO\_CS
- Pin 2: DIO2\_CD\_CLK
- Pin 3: DIO3\_CD\_DIR
- Pin 4: DIO4\_IO\_MOSI

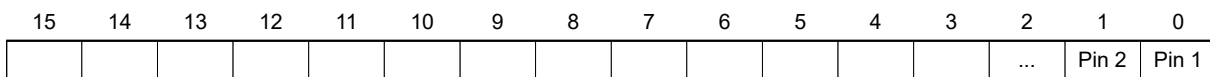

- Subindex 03<sub>h</sub> *Alternate Function Mask*: This bit mask defines whether the alternative function of the pin is to be activated.  
To activate an alternative function, set the corresponding bit to "1":

Bit	Pin	Alternative function
1	DIO2_CD_CLK	Clock input in clock-direction mode
2	DIO3_CD_DIR	Direction input in clock-direction mode

**NOTICE**



If you do not activate the alternative function, you can no longer use the corresponding pin as a normal input/output.

If the Clock-direction mode is activated, the pins for clock and direction are automatically configured accordingly and the settings in 3231<sub>h</sub> are overwritten.

- Subindex 01<sub>h</sub> *Output Mask*: This bit mask defines whether the pin is used as input or output (depending on whether an alternative function was activated for the pin in subindex 03<sub>h</sub>):
  - Bit = "0": Pin is input (default)
  - Bit = "1": Pin is output
- Subindex 02<sub>h</sub> *Pullup Mask*: This bit mask defines whether the pin is a *pullup* or *pulldown*:
  - Bit = "0": Pin is *pulldown* (default)
  - Bit = "1": Pin is *pullup*

Subindex 02<sub>h</sub> is only active for the pin if it is defined as an input.

Example for subindex 01<sub>h</sub>: Pin 2 and pin 3 are to be outputs, value = "6" (=0110<sub>b</sub>)

### Object description

Index	3231 <sub>h</sub>
Object name	Flex IO Configuration
Object Code	ARRAY
Data type	UNSIGNED16



Savable	yes, category: application
Access	read only
PDO mapping	no
Allowed values	
Preset value	
Firmware version	FIR-v1650-B472161
Change history	

---

### Value description

---

Subindex	00 <sub>h</sub>
Name	Number Of Entries
Data type	UNSIGNED8
Access	read only
PDO mapping	no
Allowed values	
Preset value	03 <sub>h</sub>

---



---

Subindex	01 <sub>h</sub>
Name	Output Mask
Data type	UNSIGNED16
Access	read / write
PDO mapping	no
Allowed values	
Preset value	0000 <sub>h</sub>

---



---

Subindex	02 <sub>h</sub>
Name	Pullup Mask
Data type	UNSIGNED16
Access	read / write
PDO mapping	no
Allowed values	
Preset value	0000 <sub>h</sub>

---



---

Subindex	03 <sub>h</sub>
Name	Alternate Function Mask
Data type	UNSIGNED16
Access	read / write
PDO mapping	no
Allowed values	
Preset value	0000 <sub>h</sub>

---

## 3240h Digital Inputs Control

### Function

With this object, digital inputs can be manipulated as described in chapter [Digital inputs and outputs](#) .

### Object description

Index	3240 <sub>h</sub>
Object name	Digital Inputs Control
Object Code	ARRAY
Data type	UNSIGNED32
Savable	yes, category: application
Firmware version	FIR-v1426
Change history	Firmware version FIR-v1426: Subindex 01 <sub>h</sub> : "Name" entry changed from "Special Function Disable" to "Special Function Enable"  Firmware version FIR-v1512: The number of entries was changed from 8 to 9.

### Value description

Subindex	00 <sub>h</sub>
Name	Number Of Entries
Data type	UNSIGNED8
Access	read only
PDO mapping	no
Allowed values	
Preset value	08 <sub>h</sub>

Subindex	01 <sub>h</sub>
Name	Special Function Enable
Data type	UNSIGNED32
Access	read / write
PDO mapping	RX-PDO
Allowed values	
Preset value	00000000 <sub>h</sub>

Subindex	02 <sub>h</sub>
Name	Function Inverted
Data type	UNSIGNED32
Access	read / write
PDO mapping	RX-PDO
Allowed values	
Preset value	00000000 <sub>h</sub>

Subindex	03 <sub>h</sub>
Name	Force Enable
Data type	UNSIGNED32
Access	read / write
PDO mapping	RX-PDO
Allowed values	
Preset value	00000000 <sub>h</sub>
<hr/>	
Subindex	04 <sub>h</sub>
Name	Force Value
Data type	UNSIGNED32
Access	read / write
PDO mapping	RX-PDO
Allowed values	
Preset value	00000000 <sub>h</sub>
<hr/>	
Subindex	05 <sub>h</sub>
Name	Raw Value
Data type	UNSIGNED32
Access	read / write
PDO mapping	RX-PDO
Allowed values	
Preset value	00000000 <sub>h</sub>
<hr/>	
Subindex	06 <sub>h</sub>
Name	Input Range Select
Data type	UNSIGNED32
Access	read / write
PDO mapping	RX-PDO
Allowed values	
Preset value	00000000 <sub>h</sub>
<hr/>	
Subindex	07 <sub>h</sub>
Name	Differential Select
Data type	UNSIGNED32
Access	read / write
PDO mapping	RX-PDO
Allowed values	
Preset value	00000000 <sub>h</sub>
<hr/>	
Subindex	08 <sub>h</sub>
Name	Routing Enable
Data type	UNSIGNED32

Access	read / write
PDO mapping	RX-PDO
Allowed values	
Preset value	00000000 <sub>h</sub>

## Description

The subindices have the following function:

- **3240<sub>h</sub>:01<sub>h</sub>** (Special Function Enable): This bit allows special functions of an input to be switched off (value "0") or on (value "1"). If input 1 is not used as, e.g., a negative limit switch, the special function must be switched off to prevent an erroneous response to the signal generator. The object has no effect on bits 16 to 31.

The firmware evaluates the following bits:

- Bit 0: Negative limit switch
- Bit 1: Positive limit switch
- Bit 2: Home switch
- Bit 3: Interlock

If, for example, two limit switches and one home switch are used, bits 0–2 in **3240<sub>h</sub>:01<sub>h</sub>** must be set to "1".

- **3240<sub>h</sub>:02<sub>h</sub>** (Function Inverted): This subindex switches from normally open logic (a logical high level at the input yields the value "1" in object **60FD<sub>h</sub>**) to normally closed logic (the logical high level at the input yields the value "0").

This applies for the special functions (except for the clock and direction inputs) and for the normal inputs. If the bit has the value "0", normally open logic applies; for the value "1", normally closed logic applies. Bit 0 changes the logic of input 1, bit 1 changes the logic of input 2, etc.

- **3240<sub>h</sub>:03<sub>h</sub>** (Force Enable): This subindex switches on the software simulation of input values if the corresponding bit is set to "1".  
In this case, the actual values are no longer used in object **3240<sub>h</sub>:04<sub>h</sub>**, but rather the set values for the respective input. Bit 0 corresponds to input 1 here, bit 1 to input 2, etc.
- **3240<sub>h</sub>:04<sub>h</sub>** (Force Value): This bit specifies the value that is to be read as the input value if the same bit was set in object **3240<sub>h</sub>:03<sub>h</sub>**.
- **3240<sub>h</sub>:05<sub>h</sub>** (Raw Value): This object contains the unmodified input value.
- **3240<sub>h</sub>:07<sub>h</sub>** (Differential Select): With the inputs, this subindex switches between "single-ended input" (value "0" in the subindex) and "differential input" (value "1" in the subindex) if the input supports this function.
- **3240<sub>h</sub>:08<sub>h</sub>** (Routing Enable): The value "1" in this subindex activates Input Routing.

## 3242h Digital Input Routing

### Function

This object determines the source of the input routing that ends in **60FD<sub>h</sub>**.

### Object description

Index	3242 <sub>h</sub>
Object name	Digital Input Routing
Object Code	ARRAY
Data type	UNSIGNED8
Savable	yes, category: application
Access	read only
PDO mapping	no
Allowed values	

Preset value	
Firmware version	FIR-v1504
Change history	

---

### Value description

Subindex	00 <sub>h</sub>
Name	Number Of Entries
Data type	UNSIGNED8
Access	read only
PDO mapping	no
Allowed values	
Preset value	20 <sub>h</sub>

---

Subindex	01 <sub>h</sub> - 20 <sub>h</sub>
Name	Input Source For Bit #1 - #32
Data type	UNSIGNED8
Access	read / write
PDO mapping	TX-PDO
Allowed values	
Preset value	00 <sub>h</sub>

---

## 3243h Digital Input Homing Capture

### Function

With this object, the current position can be noted automatically if a level change occurs at the digital input that is used for the home switch.

#### NOTICE



Do not use this function in combination with a homing operation. The homing operation cannot otherwise be successfully completed.

---

### Object description

Index	3243 <sub>h</sub>
Object name	Digital Input Homing Capture
Object Code	ARRAY
Data type	UNSIGNED32
Savable	yes, category: application
Access	read only
PDO mapping	no
Allowed values	
Preset value	
Firmware version	FIR-v1738-B501312

Change history

---

## Value description

Subindex	00 <sub>h</sub>
Name	Number Of Entries
Data type	UNSIGNED8
Access	read only
PDO mapping	no
Allowed values	
Preset value	04 <sub>h</sub>

Subindex	01 <sub>h</sub>
Name	Control
Data type	UNSIGNED32
Access	read / write
PDO mapping	RX-PDO
Allowed values	
Preset value	00000000 <sub>h</sub>

Subindex	02 <sub>h</sub>
Name	Capture Count
Data type	UNSIGNED32
Access	read / write
PDO mapping	RX-PDO
Allowed values	
Preset value	00000000 <sub>h</sub>

Subindex	03 <sub>h</sub>
Name	Value
Data type	UNSIGNED32
Access	read / write
PDO mapping	RX-PDO
Allowed values	
Preset value	00000000 <sub>h</sub>

Subindex	04 <sub>h</sub>
Name	Sensor Raw Value
Data type	UNSIGNED32
Access	read / write
PDO mapping	RX-PDO
Allowed values	
Preset value	00000000 <sub>h</sub>

## Description

- Subindex 01<sub>h</sub>: This is used to select the type of level change:
  - Deactivate function: Value "0"
  - With rising edge: Value "1"
  - With falling edge: Value "2"
  - Both edges: Value "3"
- Subindex 02<sub>h</sub>: Specifies the number of the noted level changes since the time the function was started; is reset to 0 if subindex 01<sub>h</sub> is set to 1,2 or 3
- Subindex 03<sub>h</sub>: Encoder position of the level change (in absolute user units from 6064<sub>h</sub>)
- Subindex 04<sub>h</sub>: Encoder position of the level change

## 3250h Digital Outputs Control

### Function

This object can be used to control the digital outputs as described in chapter " [Digital inputs and outputs](#) " .

The following applies for all subindices:

- Bits 0 to 15 control the special functions.
- Bits 16 to 31 control the level of the outputs.

### Object description

Index	3250 <sub>h</sub>
Object name	Digital Outputs Control
Object Code	ARRAY
Data type	UNSIGNED32
Savable	yes, category: application
Access	read only
PDO mapping	no
Allowed values	
Preset value	
Firmware version	FIR-v1426
Change history	<p>Firmware version FIR-v1426: Subindex 01<sub>h</sub>: "Name" entry changed from "Special Function Disable" to "Special Function Enable"</p> <p>Firmware version FIR-v1446: "Name" entry changed from "Special Function Enable" to "No Function".</p> <p>Firmware version FIR-v1512: The number of entries was changed from 6 to 9.</p> <p>Firmware version FIR-v2039: Subindex 09 added</p>

### Value description

Subindex	00 <sub>h</sub>
Name	Number Of Entries
Data type	UNSIGNED8
Access	read only
PDO mapping	no

Allowed values	
Preset value	09 <sub>h</sub>
<hr/>	
Subindex	01 <sub>h</sub>
Name	No Function
Data type	UNSIGNED32
Access	read / write
PDO mapping	RX-PDO
Allowed values	
Preset value	00000000 <sub>h</sub>
<hr/>	
Subindex	02 <sub>h</sub>
Name	Function Inverted
Data type	UNSIGNED32
Access	read / write
PDO mapping	RX-PDO
Allowed values	
Preset value	00000000 <sub>h</sub>
<hr/>	
Subindex	03 <sub>h</sub>
Name	Force Enable
Data type	UNSIGNED32
Access	read / write
PDO mapping	RX-PDO
Allowed values	
Preset value	00000000 <sub>h</sub>
<hr/>	
Subindex	04 <sub>h</sub>
Name	Force Value
Data type	UNSIGNED32
Access	read / write
PDO mapping	RX-PDO
Allowed values	
Preset value	00000000 <sub>h</sub>
<hr/>	
Subindex	05 <sub>h</sub>
Name	Raw Value
Data type	UNSIGNED32
Access	read / write
PDO mapping	RX-PDO
Allowed values	
Preset value	00000000 <sub>h</sub>
<hr/>	



Subindex	06 <sub>h</sub>
Name	Reserved1
Data type	UNSIGNED32
Access	read / write
PDO mapping	RX-PDO
Allowed values	
Preset value	00000000 <sub>h</sub>

Subindex	07 <sub>h</sub>
Name	Reserved2
Data type	UNSIGNED32
Access	read / write
PDO mapping	RX-PDO
Allowed values	
Preset value	00000000 <sub>h</sub>

Subindex	08 <sub>h</sub>
Name	Routing Enable
Data type	UNSIGNED32
Access	read / write
PDO mapping	RX-PDO
Allowed values	
Preset value	00000000 <sub>h</sub>

Subindex	09 <sub>h</sub>
Name	Enable Mask [Bit0=StatusLed, Bit1=ErrorLed]
Data type	UNSIGNED32
Access	read / write
PDO mapping	RX-PDO
Allowed values	
Preset value	FFFFFFFF <sub>h</sub>

## Description

The subindices have the following function:

- 01<sub>h</sub>: No function.
- 02<sub>h</sub>: This subindex is used to invert the logic (from normally closed logic to normally open logic).
- 03<sub>h</sub>: This subindex is used to force the output value if the bit has the value "1". The level of the output is defined in subindex 4<sub>h</sub>.
- 04<sub>h</sub>: This subindex is used to define the level to be applied to the output. The value "0" returns a logical low level at the digital output; the value "1", on the other hand, returns a logical high level.
- 05<sub>h</sub>: The bit combination applied to the outputs is stored in this subindex.
- 08<sub>h</sub>: If the subindex is set to "1", *Output Routing* is activated.

<b>NOTICE</b>
---------------



Entries `3250h:01h` to `3250:04h` then have **no** function until *Output Routing* is again switched off.

- `09h`: For switching control of the *Power LED* on/off. If bit 0 is set to "1", the green LED is activated (flashes in normal operation). If bit 1 is set to "1", the red LED is activated (flashes in case of an error). If the bit is set to "0", the respective LED remains off.

## 3252h Digital Output Routing

### Function

This object assigns a signal source to an output; this signal source can be controlled with `60FEh`. You can find details in chapter *Output Routing*.

### Object description

Index	3252h
Object name	Digital Output Routing
Object Code	ARRAY
Data type	UNSIGNED16
Savable	yes, category: application
Access	read only
PDO mapping	no
Allowed values	
Preset value	
Firmware version	FIR-v1540
Change history	<p>Firmware version FIR-v2213-B1029645: entry "Name" changed from "Control Bit Of 60FEh:1h And Source For Brake Output" to "Control Bit Of 60FEh:1h And Source For Brake Output".</p> <p>Firmware version FIR-v2213-B1029645: entry "Name" changed from "Control Bit Of 60FEh:1h And Source For Output #1" to "Control Bit Of 60FEh:1h And Source For Output #1".</p> <p>Firmware version FIR-v2213-B1029645: entry "Name" changed from "Control Bit Of 60FEh:1h And Source For Output #2" to "Control Bit Of 60FEh:1h And Source For Output #2".</p> <p>Firmware version FIR-v2213-B1029645: entry "Name" changed from "Control Bit Of 60FEh:1h And Source For Output #3" to "Control Bit Of 60FEh:1h And Source For Output #3".</p> <p>Firmware version FIR-v2213-B1029645: entry "Name" changed from "Control Bit Of 60FEh:1h And Source For Output #4" to "Control Bit Of 60FEh:1h And Source For Output #4".</p>

### Value description

Subindex	00h
Name	Number Of Entries
Data type	UNSIGNED8
Access	read only
PDO mapping	no

Allowed values	
Preset value	05 <sub>h</sub>
<hr/>	
Subindex	01 <sub>h</sub>
Name	Control Bit Of 60FEh:1h And Source For Brake Output
Data type	UNSIGNED16
Access	read / write
PDO mapping	TX-PDO
Allowed values	
Preset value	1080 <sub>h</sub>
<hr/>	
Subindex	02 <sub>h</sub>
Name	Control Bit Of 60FEh:1h And Source For Output #1
Data type	UNSIGNED16
Access	read / write
PDO mapping	TX-PDO
Allowed values	
Preset value	0090 <sub>h</sub>
<hr/>	
Subindex	03 <sub>h</sub>
Name	Control Bit Of 60FEh:1h And Source For Output #2
Data type	UNSIGNED16
Access	read / write
PDO mapping	TX-PDO
Allowed values	
Preset value	0091 <sub>h</sub>
<hr/>	
Subindex	04 <sub>h</sub>
Name	Control Bit Of 60FEh:1h And Source For Output #3
Data type	UNSIGNED16
Access	read / write
PDO mapping	TX-PDO
Allowed values	
Preset value	0092 <sub>h</sub>
<hr/>	
Subindex	05 <sub>h</sub>
Name	Control Bit Of 60FEh:1h And Source For Output #4
Data type	UNSIGNED16
Access	read / write
PDO mapping	TX-PDO
Allowed values	
Preset value	0093 <sub>h</sub>

## 3320h Analog Input Values

### Function

This object displays the instantaneous values of the analog inputs in user-defined units.

### Object description

Index	3320 <sub>h</sub>
Object name	Analog Input Values
Object Code	ARRAY
Data type	INTEGER32
Savable	no
Access	read only
PDO mapping	no
Allowed values	
Preset value	
Firmware version	FIR-v1426
Change history	

### Value description

Subindex	00 <sub>h</sub>
Name	Number Of Analog Input Values
Data type	UNSIGNED8
Access	read only
PDO mapping	no
Allowed values	
Preset value	02 <sub>h</sub>

Subindex	01 <sub>h</sub> - 02 <sub>h</sub>
Name	Analog Input #1 - #2
Data type	INTEGER32
Access	read only
PDO mapping	TX-PDO
Allowed values	
Preset value	00000000 <sub>h</sub>

### Description

The user-defined units are made up of offset (3321<sub>h</sub>) and scaling value (3322<sub>h</sub>/ 3323<sub>h</sub>). If both are still set to the default values, the value in 3320<sub>h</sub> is specified in the *ADC Digits* unit.

Formula for converting from digits to the respective unit:

- Voltage input:  $x \text{ digits} * 3.3 \text{ V} / 1023 \text{ digits}$
- Current input (if configurable):  $x \text{ digits} * 20 \text{ mA} / 1023 \text{ digits}$

The following applies for the sub-entries:

- Subindex 00<sub>h</sub>: Number of analog inputs

- Subindex 01<sub>h</sub>: Analog value 1
- Subindex 02<sub>h</sub>: Analog value 2 (if present)

## 3321h Analog Input Offsets

### Function

Offset that is added to the read analog value (3220<sub>h</sub>) before scaling (multiplier from object 3322 and divisor from object 3323<sub>h</sub>).

### Object description

Index	3321 <sub>h</sub>
Object name	Analog Input Offsets
Object Code	ARRAY
Data type	INTEGER16
Savable	yes, category: application
Access	read only
PDO mapping	no
Allowed values	
Preset value	
Firmware version	FIR-v1426
Change history	

### Value description

Subindex	00 <sub>h</sub>
Name	Number Of Analog Input Offsets
Data type	UNSIGNED8
Access	read only
PDO mapping	no
Allowed values	
Preset value	02 <sub>h</sub>

Subindex	01 <sub>h</sub> - 02 <sub>h</sub>
Name	Analog Input #1 - #2
Data type	INTEGER16
Access	read / write
PDO mapping	no
Allowed values	
Preset value	0000 <sub>h</sub>

### Description

- Subindex 00<sub>h</sub>: Number of offsets
- Subindex 01<sub>h</sub>: Offset for analog input 1
- Subindex 02<sub>h</sub>: Offset for analog input 2 (if present)

## 3322h Analog Input Numerators

### Function

Value by which the read analog value (3220<sub>h</sub>, 3321<sub>h</sub>) is multiplied before it is written in object 3320<sub>h</sub>.

### Object description

Index	3322 <sub>h</sub>
Object name	Analog Input Numerators
Object Code	ARRAY
Data type	INTEGER16
Savable	yes, category: application
Access	read only
PDO mapping	no
Allowed values	
Preset value	
Firmware version	FIR-v1426
Change history	

### Value description

Subindex	00 <sub>h</sub>
Name	Number Of Analog Input Numerators
Data type	UNSIGNED8
Access	read only
PDO mapping	no
Allowed values	
Preset value	02 <sub>h</sub>

Subindex	01 <sub>h</sub> - 02 <sub>h</sub>
Name	Analog Input #1 - #2
Data type	INTEGER16
Access	read / write
PDO mapping	no
Allowed values	
Preset value	0001 <sub>h</sub>

### Description

The subindices contain:

- Subindex 01<sub>h</sub>: Multiplier for analog input 1
- Subindex 02<sub>h</sub>: Multiplier for analog input 2 (if present)

## 3323h Analog Input Denominators

### Function

Value by which the read analog value (3220<sub>h</sub>+ 3321<sub>h</sub>) is divided before it is written in object 3320<sub>h</sub>.

### Object description

Index	3323 <sub>h</sub>
Object name	Analog Input Denominators
Object Code	ARRAY
Data type	INTEGER16
Savable	yes, category: application
Access	read only
PDO mapping	no
Allowed values	
Preset value	
Firmware version	FIR-v1926-B648637
Change history	

### Value description

Subindex	00 <sub>h</sub>
Name	Number Of Analog Input Denominators
Data type	UNSIGNED8
Access	read only
PDO mapping	no
Allowed values	
Preset value	02 <sub>h</sub>

Subindex	01 <sub>h</sub> - 02 <sub>h</sub>
Name	Analog Input #1 - #2
Data type	INTEGER16
Access	read / write
PDO mapping	no
Allowed values	
Preset value	0001 <sub>h</sub>

### Description

The subindices contain:

- Subindex 01<sub>h</sub>: Divisor for analog input 1
- Subindex 02<sub>h</sub>: Divisor for analog input 2 (if present)

## 3380h Feedback Sensorless

### Function

Contains measurement and configuration values that are necessary for the sensorless control and field weakening in Closed-Loop.

### Object description

Index	3380 <sub>h</sub>
Object name	Feedback Sensorless
Object Code	ARRAY
Data type	UNSIGNED32
Savable	yes, category: tuning
Access	read only
PDO mapping	RX-PDO
Allowed values	
Preset value	
Firmware version	FIR-v2013-B726332
Change history	Firmware version FIR-v2013-B726332: The number of entries was changed from 7 to 6.

### Value description

Subindex	00 <sub>h</sub>
Name	Number Of Entries
Data type	UNSIGNED8
Access	read only
PDO mapping	RX-PDO
Allowed values	
Preset value	05 <sub>h</sub>

Subindex	01 <sub>h</sub>
Name	Resistance [Ohm]
Data type	UNSIGNED32
Access	read / write
PDO mapping	RX-PDO
Allowed values	
Preset value	00000000 <sub>h</sub>

Subindex	02 <sub>h</sub>
Name	Inductance [H]
Data type	UNSIGNED32
Access	read / write
PDO mapping	RX-PDO
Allowed values	



Preset value	00000000 <sub>h</sub>
--------------	-----------------------

Subindex	03 <sub>h</sub>
Name	Magnetic Flux [Vs]
Data type	UNSIGNED32
Access	read / write
PDO mapping	RX-PDO
Allowed values	
Preset value	00000000 <sub>h</sub>

Subindex	04 <sub>h</sub>
Name	Switch On Speed [rpm]
Data type	UNSIGNED32
Access	read / write
PDO mapping	RX-PDO
Allowed values	
Preset value	00000078 <sub>h</sub>

Subindex	05 <sub>h</sub>
Name	Switch Off Speed [rpm]
Data type	UNSIGNED32
Access	read / write
PDO mapping	RX-PDO
Allowed values	
Preset value	00000064 <sub>h</sub>

## Description

The subindices have the following function:

- 01<sub>h</sub>: Winding resistance. Float value, shown here as UNSIGNED32. Is determined by [Auto setup](#).
- 02<sub>h</sub>: Winding inductance. Float value, shown here as UNSIGNED32. Is determined by [Auto setup](#).
- 03<sub>h</sub>: Interlinking flux. Float value, shown here as UNSIGNED32. Is determined by [Auto setup](#).
- 04<sub>h</sub>: Switch-on speed in RPM. *Closed loop ( sensorless)* is activated above this speed if no sensors were detected by [Auto setup](#).
- 05<sub>h</sub>: Switch-off speed in RPM. *Closed loop ( sensorless)* is deactivated below this speed if no sensors were detected by [Auto setup](#).

## 3390h Feedback Hall

### Function

Contains configuration values for the Hall sensors. The values are determined by the [Auto setup](#).

### Object description

Index	3390 <sub>h</sub>
Object name	Feedback Hall

Object Code	ARRAY
Data type	UNSIGNED16
Savable	yes, category: tuning
Access	read only
PDO mapping	RX-PDO
Allowed values	
Preset value	
Firmware version	FIR-v1748-B531667
Change history	

---

## Value description

Subindex	00 <sub>h</sub>
Name	Number Of Entries
Data type	UNSIGNED8
Access	read only
PDO mapping	RX-PDO
Allowed values	
Preset value	0C <sub>h</sub>

---

Subindex	01 <sub>h</sub>
Name	1st Alignment
Data type	UNSIGNED16
Access	read / write
PDO mapping	RX-PDO
Allowed values	
Preset value	0000 <sub>h</sub>

---

Subindex	02 <sub>h</sub>
Name	2nd Alignment
Data type	UNSIGNED16
Access	read / write
PDO mapping	RX-PDO
Allowed values	
Preset value	0000 <sub>h</sub>

---

Subindex	03 <sub>h</sub>
Name	3rd Alignment
Data type	UNSIGNED16
Access	read / write
PDO mapping	RX-PDO
Allowed values	
Preset value	0000 <sub>h</sub>

---

---

Subindex	04 <sub>h</sub>
Name	4th Alignment
Data type	UNSIGNED16
Access	read / write
PDO mapping	RX-PDO
Allowed values	
Preset value	0000 <sub>h</sub>

---



---

Subindex	05 <sub>h</sub>
Name	5th Alignment
Data type	UNSIGNED16
Access	read / write
PDO mapping	RX-PDO
Allowed values	
Preset value	0000 <sub>h</sub>

---



---

Subindex	06 <sub>h</sub>
Name	6th Alignment
Data type	UNSIGNED16
Access	read / write
PDO mapping	RX-PDO
Allowed values	
Preset value	0000 <sub>h</sub>

---



---

Subindex	07 <sub>h</sub>
Name	7th Alignment
Data type	UNSIGNED16
Access	read / write
PDO mapping	RX-PDO
Allowed values	
Preset value	0000 <sub>h</sub>

---



---

Subindex	08 <sub>h</sub>
Name	8th Alignment
Data type	UNSIGNED16
Access	read / write
PDO mapping	RX-PDO
Allowed values	
Preset value	0000 <sub>h</sub>

---



---

Subindex	09 <sub>h</sub>
Name	9th Alignment
Data type	UNSIGNED16

---

Access	read / write
PDO mapping	RX-PDO
Allowed values	
Preset value	0000 <sub>h</sub>

---

Subindex	0A <sub>h</sub>
Name	10th Alignment
Data type	UNSIGNED16
Access	read / write
PDO mapping	RX-PDO
Allowed values	
Preset value	0000 <sub>h</sub>

---

Subindex	0B <sub>h</sub>
Name	11th Alignment
Data type	UNSIGNED16
Access	read / write
PDO mapping	RX-PDO
Allowed values	
Preset value	0000 <sub>h</sub>

---

Subindex	0C <sub>h</sub>
Name	12th Alignment
Data type	UNSIGNED16
Access	read / write
PDO mapping	RX-PDO
Allowed values	
Preset value	0000 <sub>h</sub>

## 33A0h Feedback Incremental A/B/I 1

### Function

Contains configuration values for the first incremental encoder. The values are determined by the [Auto setup](#).

### Object description

---

Index	33A0 <sub>h</sub>
Object name	Feedback Incremental A/B/I 1
Object Code	ARRAY
Data type	UNSIGNED16
Savable	yes, category: tuning
Access	read only
PDO mapping	RX-PDO
Allowed values	

Preset value	
Firmware version	FIR-v1738-B501312
Change history	

---

## Value description

Subindex	00 <sub>h</sub>
Name	Number Of Entries
Data type	UNSIGNED8
Access	read only
PDO mapping	RX-PDO
Allowed values	
Preset value	02 <sub>h</sub>

---

Subindex	01 <sub>h</sub>
Name	Configuration
Data type	UNSIGNED16
Access	read / write
PDO mapping	RX-PDO
Allowed values	
Preset value	0000 <sub>h</sub>

---

Subindex	02 <sub>h</sub>
Name	Alignment
Data type	UNSIGNED16
Access	read / write
PDO mapping	RX-PDO
Allowed values	
Preset value	0000 <sub>h</sub>

---

## Description

The subindices have the following function:

- 01<sub>h</sub> (Configuration): The following bits have a meaning:
  - Bit 0: Value = "0": The encoder does not have an index. Value = "1": Encoder index exists and is to be used.
- 02<sub>h</sub> (Alignment): This value specifies the offset between the index of the encoder and the rotor's magnets. The exact determination is possible via [auto setup](#). The presence of this value is necessary for *closed loop* mode with encoder.

## 33A1h Feedback Incremental A/B/I 2

### Function

Contains configuration values for the second incremental encoder. The values are determined by the [Auto setup](#).

## Object description

Index	33A1 <sub>h</sub>
Object name	Feedback Incremental A/B/I 2
Object Code	ARRAY
Data type	UNSIGNED16
Savable	yes, category: tuning
Access	read only
PDO mapping	RX-PDO
Allowed values	
Preset value	
Firmware version	FIR-v1748-B533384
Change history	

## Value description

Subindex	00 <sub>h</sub>
Name	Number Of Entries
Data type	UNSIGNED8
Access	read only
PDO mapping	RX-PDO
Allowed values	
Preset value	02 <sub>h</sub>

Subindex	01 <sub>h</sub>
Name	Configuration
Data type	UNSIGNED16
Access	read / write
PDO mapping	RX-PDO
Allowed values	
Preset value	0000 <sub>h</sub>

Subindex	02 <sub>h</sub>
Name	Alignment
Data type	UNSIGNED16
Access	read / write
PDO mapping	RX-PDO
Allowed values	
Preset value	0000 <sub>h</sub>

## Description

### Description

The subindices have the following function:

- 01<sub>h</sub> (Configuration): The following bits have a meaning:
  - Bit 0: Value = "0": The encoder does not have an index. Value = "1": Encoder index exists and is to be used.
- 02<sub>h</sub> (Alignment): This value specifies the offset between the index of the encoder and the rotor's magnets. The exact determination is possible via [auto\\_setup](#). The presence of this value is necessary for *closed loop* mode with encoder.

## 3700h Deviation Error Option Code

### Function

The object contains the action that is to be executed if a following or slippage error is triggered.

### Object description

Index	3700 <sub>h</sub>
Object name	Deviation Error Option Code
Object Code	VARIABLE
Data type	INTEGER16
Savable	yes, category: application
Access	read / write
PDO mapping	no
Allowed values	
Preset value	FFFF <sub>h</sub>
Firmware version	FIR-v1426
Change history	Firmware version FIR-v1738-B501312: "Object Name" entry changed from "Following Error Option Code" to "Deviation Error Option Code".

### Description

Value	Description
-32768 ... -2	Reserved
-1	no reaction
0	Switch off driver without deceleration ramp; drive function blocked – motor can turn freely
1	Braking with <i>slow down ramp</i> (braking deceleration depending on operating mode)
2	Braking with <i>quick stop ramp</i> (6085 <sub>h</sub> )
3 ... 32767	reserved

## 3701h Limit Switch Error Option Code

### Function

If a limit switch is passed over, bit 7 ( *Warning*) is set in 6041<sub>h</sub> ( *statusword*) and the action that is stored in this object executed. See chapter [Limitation of the range of motion](#).

## Object description

Index	3701 <sub>h</sub>
Object name	Limit Switch Error Option Code
Object Code	VARIABLE
Data type	INTEGER16
Savable	yes, category: application
Access	read / write
PDO mapping	no
Allowed values	
Preset value	FFFF <sub>h</sub>
Firmware version	FIR-v1748-B538662
Change history	

## Description

Value in object 3701 <sub>h</sub>	Description
-2	No reaction, discard the limit switch position
-1 (factory settings)	No reaction (e. g., to execute a homing operation) except noting the limit switch position
0	Switch off driver without deceleration ramp; drive function blocked – motor can turn freely ( <i>Switch on disabled</i> state)
1	Braking with <i>slow down ramp</i> (deceleration ramp depending on operating mode) and subsequent state change to <i>Switch on disabled</i>
2	Braking with <i>quick stop ramp</i> and subsequent state change to <i>Switch on disabled</i>
5	Braking with <i>slow down ramp</i> (deceleration ramp depending on operating mode) and subsequent state change to <i>Quick stop active</i> ; control does not switch off and the motor remains energized. You can switch back to the <i>Operation enabled</i> state.
6	Braking with <i>quick stop ramp</i> and subsequent state change to <i>Quick Stop Active</i> ; control does not switch off and the motor remains energized. You can switch back to the <i>Operation enabled</i> state.

## 4012h HW Information

### Function

This object contains information about the hardware.

### Object description

Index	4012 <sub>h</sub>
Object name	HW Information
Object Code	ARRAY
Data type	UNSIGNED32
Savable	no
Access	read only
PDO mapping	no



Allowed values	
Preset value	
Firmware version	FIR-v1540
Change history	

---

## Value description

Subindex	00 <sub>h</sub>
Name	Number Of Entries
Data type	UNSIGNED8
Access	read only
PDO mapping	no
Allowed values	
Preset value	01 <sub>h</sub>

---

Subindex	01 <sub>h</sub>
Name	EEPROM Size In Bytes
Data type	UNSIGNED32
Access	read only
PDO mapping	no
Allowed values	
Preset value	00000000 <sub>h</sub>

---

## Description

Subindex 01: Contains the size of the connected EEPROM in bytes. The value "0" means that no EEPROM is connected.

## 4013h HW Configuration

### Function

This object is used to set certain hardware configurations.

### Object description

Index	4013 <sub>h</sub>
Object name	HW Configuration
Object Code	ARRAY
Data type	UNSIGNED32
Savable	yes, category: application
Access	read only
PDO mapping	no
Allowed values	
Preset value	
Firmware version	FIR-v1540
Change history	

---

## Value description

Subindex	00 <sub>h</sub>
Name	Number Of Entries
Data type	UNSIGNED8
Access	read only
PDO mapping	no
Allowed values	
Preset value	01 <sub>h</sub>

Subindex	01 <sub>h</sub>
Name	HW Configuration #1
Data type	UNSIGNED32
Access	read / write
PDO mapping	no
Allowed values	
Preset value	00000000 <sub>h</sub>

## Description

reserved

## 4014h Operating Conditions

### Function

This object is used to read out the current environment values for the controller.

### Object description

Index	4014 <sub>h</sub>
Object name	Operating Conditions
Object Code	ARRAY
Data type	INTEGER32
Savable	no
Access	read only
PDO mapping	no
Allowed values	
Preset value	
Firmware version	FIR-v1540
Change history	<p>Firmware version FIR-v1650-B472161: "Access" table entry for subindex 01 changed from "read/write" to "read only".</p> <p>Firmware version FIR-v1650-B472161: "Access" table entry for subindex 02 changed from "read/write" to "read only".</p> <p>Firmware version FIR-v1650-B472161: "Name" entry changed from "Temperature PCB [d?C]" to "Temperature PCB [Celsius * 10]".</p> <p>Firmware version FIR-v1650-B472161: "Access" table entry for subindex 03 changed from "read/write" to "read only".</p>

Firmware version FIR-v1738-B501312: The number of entries was changed from 4 to 6.

## Value description

Subindex	00 <sub>h</sub>
Name	Number Of Entries
Data type	UNSIGNED8
Access	read only
PDO mapping	no
Allowed values	
Preset value	05 <sub>h</sub>

Subindex	01 <sub>h</sub>
Name	Voltage UB Power [mV]
Data type	INTEGER32
Access	read only
PDO mapping	TX-PDO
Allowed values	
Preset value	00000000 <sub>h</sub>

Subindex	02 <sub>h</sub>
Name	Voltage UB Logic [mV]
Data type	INTEGER32
Access	read only
PDO mapping	TX-PDO
Allowed values	
Preset value	00000000 <sub>h</sub>

Subindex	03 <sub>h</sub>
Name	Temperature PCB [Celsius * 10]
Data type	INTEGER32
Access	read only
PDO mapping	TX-PDO
Allowed values	
Preset value	00000000 <sub>h</sub>

Subindex	04 <sub>h</sub>
Name	Temperature Motor [Celsius * 10]
Data type	INTEGER32
Access	read only
PDO mapping	TX-PDO
Allowed values	

Preset value	00000000 <sub>h</sub>
--------------	-----------------------

Subindex	05 <sub>h</sub>
Name	Temperature Microcontroller Chip [Celsius * 10]
Data type	INTEGER32
Access	read only
PDO mapping	TX-PDO
Allowed values	
Preset value	00000000 <sub>h</sub>

## Description

The subindices contain:

- 01<sub>h</sub>: Current voltage supply voltage in [mV]
- 02<sub>h</sub>: Current logic voltage in [mV]
- 03<sub>h</sub>: Current temperature of the control board in [d°C] (tenths of degree)
- 04<sub>h</sub>: Reserves
- 05<sub>h</sub>: Reserves

## 4021h Ballast Configuration

### Function

With this object, you switch the ballast circuit on or off and determine its response threshold. Furthermore, you configure the ballast monitoring. You can find details in chapter [External ballast circuit](#).

### Object description

Index	4021 <sub>h</sub>
Object name	Ballast Configuration
Object Code	ARRAY
Data type	UNSIGNED32
Savable	yes, category: tuning
Access	read only
PDO mapping	no
Allowed values	
Preset value	
Firmware version	FIR-v2013-B726332
Change history	

### Value description

Subindex	00 <sub>h</sub>
Name	Number Of Entries
Data type	UNSIGNED8
Access	read only
PDO mapping	no
Allowed values	

Preset value	08 <sub>h</sub>
Subindex	01 <sub>h</sub>
Name	Settings [Bit0: On/Off, Bit1: Polarity]
Data type	UNSIGNED32
Access	read / write
PDO mapping	no
Allowed values	
Preset value	00000000 <sub>h</sub>
Subindex	02 <sub>h</sub>
Name	UB Power Limit [mV]
Data type	UNSIGNED32
Access	read / write
PDO mapping	no
Allowed values	
Preset value	0000ED49 <sub>h</sub>
Subindex	03 <sub>h</sub>
Name	UB Power Hysteresis [mV]
Data type	UNSIGNED32
Access	read / write
PDO mapping	no
Allowed values	
Preset value	000001F4 <sub>h</sub>
Subindex	04 <sub>h</sub>
Name	Nominal Resistance [mOhm]
Data type	UNSIGNED32
Access	read / write
PDO mapping	no
Allowed values	
Preset value	00000001 <sub>h</sub>
Subindex	05 <sub>h</sub>
Name	Long Term Energy Limit [mWs]
Data type	UNSIGNED32
Access	read / write
PDO mapping	no
Allowed values	
Preset value	00000001 <sub>h</sub>
Subindex	06 <sub>h</sub>

Name	Long Term Reference Time [ms]
Data type	UNSIGNED32
Access	read / write
PDO mapping	no
Allowed values	
Preset value	00000000 <sub>h</sub>

Subindex	07 <sub>h</sub>
Name	Short Term Energy Limit [mWs]
Data type	UNSIGNED32
Access	read / write
PDO mapping	no
Allowed values	
Preset value	00000000 <sub>h</sub>

Subindex	08 <sub>h</sub>
Name	Cooling Power [mW]
Data type	UNSIGNED32
Access	read / write
PDO mapping	no
Allowed values	
Preset value	00000000 <sub>h</sub>

## Description

The subindices have the following function:

- 01<sub>h</sub>:
  - Bit 0: Switches the ballast on (value = "1") or off (value = "0")
  - Bit 1: Inverts (value = "1") the polarity of the pins for controlling the external ballast circuit (factory setting: *active high*)
- 02<sub>h</sub>: Response threshold (switch on/off) of the ballast circuit
- 03<sub>h</sub>: Hysteresis for the response threshold (switch on/off)
- 04<sub>h</sub>: Rated value of the ballast resistor
- 04<sub>h</sub>: Rated value of the ballast resistor
- 05<sub>h</sub>: Amount of energy that can be supplied to the resistor within the *Long Term Reference Time* (subindex 06<sub>h</sub>) without overloading it.
- 06<sub>h</sub>: The reference time for the *Long Term Energy Limit* (subindex 05<sub>h</sub>) (typically between 1 and 5 seconds)
- 07<sub>h</sub>: Amount of energy that can be supplied to the resistor within a short load surge (<1 second) without overloading it.
- 08<sub>h</sub>: The amount of heat that the resistor can/may constantly discharge to its surroundings.

## 4040h Drive Serial Number

### Function

This object contains the serial number of the controller.

## Object description

---

Index	4040 <sub>h</sub>
Object name	Drive Serial Number
Object Code	VARIABLE
Data type	VISIBLE_STRING
Savable	no
Access	read only
PDO mapping	no
Allowed values	
Preset value	0
Firmware version	FIR-v1450
Change history	

---

## 4041h Device Id

### Function

This object contains the ID of the device.

### Object description

---

Index	4041 <sub>h</sub>
Object name	Device Id
Object Code	VARIABLE
Data type	OCTET_STRING
Savable	no
Access	read only
PDO mapping	no
Allowed values	
Preset value	0
Firmware version	FIR-v1540
Change history	

---

## 4042h Bootloader Infos

### Object description

---

Index	4042 <sub>h</sub>
Object name	Bootloader Infos
Object Code	ARRAY
Data type	UNSIGNED32
Savable	no
Access	read only
PDO mapping	no
Allowed values	
Preset value	

Firmware version	FIR-v2013-B726332
Change history	

---

## Value description

Subindex	00 <sub>h</sub>
Name	Number Of Entries
Data type	UNSIGNED8
Access	read only
PDO mapping	no
Allowed values	
Preset value	03 <sub>h</sub>

---

Subindex	01 <sub>h</sub>
Name	Bootloader Version
Data type	UNSIGNED32
Access	read only
PDO mapping	no
Allowed values	
Preset value	00000000 <sub>h</sub>

---

Subindex	02 <sub>h</sub>
Name	Bootloader Supported Fieldbus
Data type	UNSIGNED32
Access	read only
PDO mapping	no
Allowed values	
Preset value	00000000 <sub>h</sub>

---

Subindex	03 <sub>h</sub>
Name	Bootloader Hw-group
Data type	UNSIGNED32
Access	read only
PDO mapping	no
Allowed values	
Preset value	00000000 <sub>h</sub>

---

## Description

The subindices have the following functions:

- 01<sub>h</sub>: Version of the boot loader. The 4 most significant bytes contain the main version number; the 4 least significant bytes contain the minor version number. Example for version 4.2: 00040002<sub>h</sub>
- 02<sub>h</sub>: Fieldbuses supported by the boot loader. The bits have the same function as the bits of object 2101h Fieldbus Module Availability.



## 6007h Abort Connection Option Code

### Function

If an error (watchdog, heartbeat, etc.) occurs on the bus, the controller automatically switches to the SAFEOPERATIONAL state. With this object, you can set the reaction.

### Object description

Index	6007 <sub>h</sub>
Object name	Abort Connection Option Code
Object Code	VARIABLE
Data type	INTEGER16
Savable	yes, category: application
Access	read / write
PDO mapping	no
Allowed values	
Preset value	0001 <sub>h</sub>
Firmware version	FIR-v2013-B726332
Change history	

### Description

You can set the following reactions:

Value	Reaction
-1	The controller (slave) sets all input values (RX-PDO) to the value "0". This also sets the object <u>6040<sub>h</sub></u> (controlword) to "0", which causes the motor to coast to a stop.
0	no reaction
1	<i>Fault:</i> The action stored in object <u>605E<sub>h</sub></u> is executed.
2	<i>Disable voltage:</i> Transition to the <i>Switched on disabled</i> state without halt motion reaction (the motor coasts to a stop)
3	<i>Quick stop:</i> The action stored in object <u>605A<sub>h</sub></u> is executed.

## 603Fh Error Code

### Function

This object returns the error code of the last error that occurred.

It corresponds to the lower 16 bits of object 1003<sub>h</sub>. For the description of the error codes, refer to object 1003<sub>h</sub>.

### Object description

Index	603F <sub>h</sub>
Object name	Error Code
Object Code	VARIABLE
Data type	UNSIGNED16
Savable	no

Access	read only
PDO mapping	TX-PDO
Allowed values	
Preset value	0000 <sub>h</sub>
Firmware version	FIR-v1426
Change history	

---

## Description

For the meaning of the error, see object 1003<sub>h</sub> (Pre-defined Error Field).

If the error is reset by setting bit 7 in 6040<sub>h</sub> Controlword, this object is also automatically reset to "0".

## 6040<sub>h</sub> Controlword

### Function

This object controls the CiA 402 Power State Machine.

### Object description

---

Index	6040 <sub>h</sub>
Object name	Controlword
Object Code	VARIABLE
Data type	UNSIGNED16
Savable	yes, category: application
Access	read / write
PDO mapping	RX-PDO
Allowed values	
Preset value	0000 <sub>h</sub>
Firmware version	FIR-v1426
Change history	Firmware version FIR-v1626: "Savable" entry changed from "no" to "yes, category: application".

---

## Description

Parts of the object are, with respect to function, dependent on the currently selected mode.

15	14	13	12	11	10	9	8	7	6	5	4	3	2	1	0
						OMS	HALT	FR		OMS [3]		EO	QS	EV	SO

### SO (Switched On)

Value = "1": Switches to the "Switched on" state

### EV (Enable Voltage)

Value = "1": Switches to the "Enable voltage" state

### QS (Quick Stop)

Value = "0": Switches to the "Quick stop" state

**EO (Enable Operation)**

Value = "1": Switches to the "Enable operation" state

**OMS (Operation Mode Specific)**

Meaning is dependent on the selected operating mode

**FR (Fault Reset)**

Resets an error or a warning (if possible)

**HALT**

Value = "1": Triggers a halt; valid in the following modes:

- Profile Position
- Velocity
- Profile Velocity
- Profile Torque
- Interpolated Position Mode

**6041h Statusword****Function**

This object returns information about the status of the CiA 402 Power State Machine.

**Object description**

---

Index	6041 <sub>h</sub>
Object name	Statusword
Object Code	VARIABLE
Data type	UNSIGNED16
Savable	no
Access	read only
PDO mapping	TX-PDO
Allowed values	
Preset value	0000 <sub>h</sub>
Firmware version	FIR-v1426
Change history	

---

**Description**

Parts of the object are, with respect to function, dependent on the currently selected mode. Refer to the corresponding section in chapter Operating modes.

15	14	13	12	11	10	9	8	7	6	5	4	3	2	1	0
CLA		OMS [2]	ILA	TARG	REM	SYNC	WARN	SOD	QS	VE	FAULT	OE	SO	RTSO	

**RTSO (Ready To Switch On)**

Value = "1": Controller is in the "Ready to switch on" state

**SO (Switched On)**

Value = "1": Controller is in the "Switched on" state

**OE (Operation Enabled)**

Value = "1": Controller is in the "Operation enabled" state

**FAULT**

Error occurred (see 1003<sub>h</sub>)

**VE (Voltage Enabled)**

Voltage applied

**QS (Quick Stop)**

Value = "0": Controller is in the "Quick stop" state

**SOD (Switched On Disabled)**

Value = "1": Controller is in the "Switched on disabled" state

**WARN (Warning)**

Value = "1": Warning

**SYNC (synchronization)**

Value = "1": Controller is in sync with the fieldbus; value = "0": Controller is not in sync with the fieldbus

**REM (Remote)**

Remote (value of the bit is always "1" )

**TARG**

Target reached

**ILA (Internal Limit Active)**

Limit exceeded

**OMS (Operation Mode Specific)**

Meaning is dependent on the selected operating mode

**CLA (Closed Loop Active)**

Value = "1": The controller is in the *Operation enabled* state and the Closed-Loop is activated.

Listed in the following table are the bit masks that break down the state of the controller.

Statusword (6041 <sub>h</sub> )	State
xxxx xxxx x0xx 0000	Not ready to switch on
xxxx xxxx x1xx 0000	Switch on disabled
xxxx xxxx x01x 0001	Ready to switch on
xxxx xxxx x01x 0011	Switched on
xxxx xxxx x01x 0111	Operation enabled
xxxx xxxx x00x 0111	Quick stop active
xxxx xxxx x0xx 1111	Fault reaction active
xxxx xxxx x0xx 1000	Fault

**6042h VI Target Velocity****Function**

Specifies the target speed in user-defined units for Velocity mode.

## Object description

---

Index	6042 <sub>h</sub>
Object name	VI Target Velocity
Object Code	VARIABLE
Data type	INTEGER16
Savable	yes, category: application
Access	read / write
PDO mapping	RX-PDO
Allowed values	
Preset value	00C8 <sub>h</sub>
Firmware version	FIR-v1426
Change history	Firmware version FIR-v1626: "Savable" entry changed from "no" to "yes, category: application".

---

## 6043h VI Velocity Demand

### Function

Speed specification in user-defined units for the controller in Velocity mode.

### Object description

---

Index	6043 <sub>h</sub>
Object name	VI Velocity Demand
Object Code	VARIABLE
Data type	INTEGER16
Savable	no
Access	read only
PDO mapping	TX-PDO
Allowed values	
Preset value	0000 <sub>h</sub>
Firmware version	FIR-v1426
Change history	

---

## 6044h VI Velocity Actual Value

### Function

Specifies the current actual speed in user-defined units in Velocity mode.

### Object description

---

Index	6044 <sub>h</sub>
Object name	VI Velocity Actual Value
Object Code	VARIABLE
Data type	INTEGER16
Savable	no

---

Access	read only
PDO mapping	TX-PDO
Allowed values	
Preset value	0000 <sub>h</sub>
Firmware version	FIR-v1426
Change history	

---

## 6046h VI Velocity Min Max Amount

### Function

This object can be used to set the minimum speed and maximum speed in user-defined units.

### Object description

Index	6046 <sub>h</sub>
Object name	VI Velocity Min Max Amount
Object Code	ARRAY
Data type	UNSIGNED32
Savable	yes, category: application
Firmware version	FIR-v1426
Change history	

---

### Value description

Subindex	00 <sub>h</sub>
Name	Number Of Entries
Data type	UNSIGNED8
Access	read only
PDO mapping	no
Allowed values	
Preset value	02 <sub>h</sub>

---

Subindex	01 <sub>h</sub>
Name	MinAmount
Data type	UNSIGNED32
Access	read / write
PDO mapping	RX-PDO
Allowed values	
Preset value	00000000 <sub>h</sub>

---

Subindex	02 <sub>h</sub>
Name	MaxAmount
Data type	UNSIGNED32
Access	read / write

PDO mapping	RX-PDO
Allowed values	
Preset value	00007530 <sub>h</sub>

---

## Description

Subindex 1 contains the minimum speed.

Subindex 2 contains the maximum speed.

If the value of the target speed (object 6042<sub>h</sub>) specified here is less than the minimum speed, the minimum speed applies and bit 11 (Internal Limit Reached) in 6041<sub>h</sub> Statusword<sub>h</sub> is set.

A target speed greater than the maximum speed sets the speed to the maximum speed and bit 11 (Internal Limit Reached) in 6041<sub>h</sub> Statusword<sub>h</sub> is set.

## 6048h VI Velocity Acceleration

### Function

Sets the acceleration ramp in Velocity Mode (see [Velocity](#)).

### Object description

Index	6048 <sub>h</sub>
Object name	VI Velocity Acceleration
Object Code	RECORD
Data type	VELOCITY_ACCELERATION_DECELERATION
Savable	yes, category: application
Firmware version	FIR-v1426
Change history	

---

### Value description

Subindex	00 <sub>h</sub>
Name	Number Of Entries
Data type	UNSIGNED8
Access	read only
PDO mapping	no
Allowed values	
Preset value	02 <sub>h</sub>

---

Subindex	01 <sub>h</sub>
Name	DeltaSpeed
Data type	UNSIGNED32
Access	read / write
PDO mapping	RX-PDO
Allowed values	
Preset value	000001F4 <sub>h</sub>

---

---

Subindex	02 <sub>h</sub>
Name	DeltaTime
Data type	UNSIGNED16
Access	read / write
PDO mapping	RX-PDO
Allowed values	
Preset value	0001 <sub>h</sub>

---

## Description

The acceleration is specified as a fraction in user-defined units:

Speed change per change in time.

Subindex 01<sub>h</sub>: Contains the change in speed.

Subindex 02<sub>h</sub>: Contains the change in time.

## 6049h VI Velocity Deceleration

### Function

Sets the deceleration (deceleration ramp) in Velocity Mode (see [Velocity](#)).

### Object description

---

Index	6049 <sub>h</sub>
Object name	VI Velocity Deceleration
Object Code	RECORD
Data type	VELOCITY_ACCELERATION_DECELERATION
Savable	yes, category: application
Firmware version	FIR-v1426
Change history	

---

### Value description

---

Subindex	00 <sub>h</sub>
Name	Number Of Entries
Data type	UNSIGNED8
Access	read only
PDO mapping	no
Allowed values	
Preset value	02 <sub>h</sub>

---



---

Subindex	01 <sub>h</sub>
Name	DeltaSpeed
Data type	UNSIGNED32
Access	read / write
PDO mapping	RX-PDO
Allowed values	

---



Preset value	000001F4 <sub>h</sub>
--------------	-----------------------

Subindex	02 <sub>h</sub>
Name	DeltaTime
Data type	UNSIGNED16
Access	read / write
PDO mapping	RX-PDO
Allowed values	
Preset value	0001 <sub>h</sub>

## Description

The deceleration is specified as a fraction in user-defined units:

Speed change per change in time.

Subindex 01<sub>h</sub>: Contains the change in speed.

Subindex 02<sub>h</sub>: Contains the change in time.

## 604Ah VI Velocity Quick Stop

### Function

This object defines the deceleration (deceleration ramp) if the Quick Stop state is initiated in velocity mode.

### Object description

Index	604A <sub>h</sub>
Object name	VI Velocity Quick Stop
Object Code	RECORD
Data type	VELOCITY_ACCELERATION_DECELERATION
Savable	yes, category: application
Firmware version	FIR-v1426
Change history	

### Value description

Subindex	00 <sub>h</sub>
Name	Number Of Entries
Data type	UNSIGNED8
Access	read only
PDO mapping	no
Allowed values	
Preset value	02 <sub>h</sub>

Subindex	01 <sub>h</sub>
Name	DeltaSpeed
Data type	UNSIGNED32

Access	read / write
PDO mapping	RX-PDO
Allowed values	
Preset value	00001388 <sub>h</sub>

---

Subindex	02 <sub>h</sub>
Name	DeltaTime
Data type	UNSIGNED16
Access	read / write
PDO mapping	RX-PDO
Allowed values	
Preset value	0001 <sub>h</sub>

## Description

The deceleration is specified as a fraction in user-defined units:

Speed change per change in time.

Subindex 01<sub>h</sub>: Contains the change in speed.

Subindex 02<sub>h</sub>: Contains the change in time.

## 604Ch VI Dimension Factor

### Function

The unit for speed values is defined here for the objects associated with velocity mode.

### Object description

---

Index	604C <sub>h</sub>
Object name	VI Dimension Factor
Object Code	ARRAY
Data type	INTEGER32
Savable	yes, category: application
Firmware version	FIR-v1426
Change history	

---

### Value description

---

Subindex	00 <sub>h</sub>
Name	Number Of Entries
Data type	UNSIGNED8
Access	read only
PDO mapping	no
Allowed values	
Preset value	02 <sub>h</sub>

---

Subindex	01 <sub>h</sub>
Name	VI Dimension Factor Numerator
Data type	INTEGER32
Access	read / write
PDO mapping	RX-PDO
Allowed values	
Preset value	00000001 <sub>h</sub>

Subindex	02 <sub>h</sub>
Name	VI Dimension Factor Denominator
Data type	INTEGER32
Access	read / write
PDO mapping	RX-PDO
Allowed values	
Preset value	00000001 <sub>h</sub>

## Description

Subindex 1 contains the numerator (multiplier) and subindex 2 contains the denominator (divisor) with which the internal speed values are converted to revolutions per minute. If, for example, subindex 1 is set to the value "60" and subindex 2 is set to the value "1", the speed is specified in revolutions per second (60 revolutions per 1 minute).

## 605Ah Quick Stop Option Code

### Function

The object contains the action that is to be executed on a transition of the CiA 402 Power State Machine to the *Quick Stop active* state.

### Object description

Index	605A <sub>h</sub>
Object name	Quick Stop Option Code
Object Code	VARIABLE
Data type	INTEGER16
Savable	yes, category: application
Access	read / write
PDO mapping	no
Allowed values	
Preset value	0002 <sub>h</sub>
Firmware version	FIR-v1426
Change history	

### Description

Value in object 605A <sub>h</sub>	Description
0	Immediate stop with subsequent state change to <i>Switch on disabled</i>

Value in object 605A <sub>h</sub>	Description
1	Braking with <i>slow down ramp</i> (deceleration ramp depending on operating mode) and subsequent state change to <i>Switch on disabled</i>
2	Braking with <i>quick stop ramp</i> (6085 <sub>h</sub> ) and subsequent state change to <i>Switch on disabled</i>
5	Braking with <i>slow down ramp</i> (deceleration ramp depending on operating mode) and subsequent state change to <i>Quick stop active</i> ; control does not switch off and the motor remains energized. You can switch back to the <i>Operation enabled</i> state.
6	Braking with <i>quick stop ramp</i> (6085 <sub>h</sub> ) and subsequent state change to <i>Quick Stop Active</i> ; control does not switch off and the motor remains energized. You can switch back to the <i>Operation enabled</i> state.

## 605Bh Shutdown Option Code

### Function

This object contains the action that is to be executed on a transition of the CiA 402 Power State Machine from the *Operation enabled* state to the *Ready to switch on* state.

### Object description

Index	605B <sub>h</sub>
Object name	Shutdown Option Code
Object Code	VARIABLE
Data type	INTEGER16
Savable	yes, category: application
Access	read / write
PDO mapping	no
Allowed values	
Preset value	0001 <sub>h</sub>
Firmware version	FIR-v1426
Change history	

### Description

Value in object 605B <sub>h</sub>	Description
-32768 ... -1	Reserved
0	Blocking of the drive function – motor can turn freely
1	Braking with <i>slow down ramp</i> (braking deceleration depending on operating mode) and subsequent state change to <i>Ready to switch on</i>
2 ... 32767	Reserved

## 605Ch Disable Option Code

### Function

This object contains the action that is to be executed on a transition of the CiA 402 Power State Machine from the *Operation enabled* state to the *Switched on* state.

### Object description

Index	605C <sub>h</sub>
Object name	Disable Option Code
Object Code	VARIABLE
Data type	INTEGER16
Savable	yes, category: application
Access	read / write
PDO mapping	no
Allowed values	
Preset value	0001 <sub>h</sub>
Firmware version	FIR-v1426
Change history	

### Description

Value in object 605C <sub>h</sub>	Description
-32768 ... -1	Reserved
0	Blocking of the drive function – motor can turn freely
1	Braking with <i>slow down ramp</i> (braking deceleration depending on operating mode) and subsequent state change to <i>Switched on</i>
2 ... 32767	Reserved

## 605Dh Halt Option Code

### Function

The object contains the action that is to be executed if bit 8 (Halt) is set in controlword 6040<sub>h</sub>.

### Object description

Index	605D <sub>h</sub>
Object name	Halt Option Code
Object Code	VARIABLE
Data type	INTEGER16
Savable	yes, category: application
Access	read / write
PDO mapping	no
Allowed values	
Preset value	0001 <sub>h</sub>
Firmware version	FIR-v1426

Change history

---

## Description

Value in object 605D <sub>h</sub>	Description
-32768 ... 0	Reserved
1	Braking with <i>slow down ramp</i> (braking deceleration depending on operating mode)
2	Braking with <i>quick stop ramp</i> (6085 <sub>h</sub> )
3 ... 32767	Reserved

## 605Eh Fault Option Code

### Function

The object contains the action specifying how the motor is to be brought to a standstill in case of an error.

### Object description

Index	605E <sub>h</sub>
Object name	Fault Option Code
Object Code	VARIABLE
Data type	INTEGER16
Savable	yes, category: application
Access	read / write
PDO mapping	no
Allowed values	
Preset value	0002 <sub>h</sub>
Firmware version	FIR-v1426
Change history	

## Description

Value in object 605E <sub>h</sub>	Description
-32768 ... -1	Reserved
0	Blocking of the drive function – motor can turn freely
1	Braking with <i>slow down ramp</i> (braking deceleration depending on operating mode)
2	Braking with <i>quick stop ramp</i> (6085 <sub>h</sub> )
3 ... 32767	Reserved

## 6060h Modes Of Operation

### Function

The desired operating mode is entered in this object.

## Object description

Index	6060 <sub>h</sub>
Object name	Modes Of Operation
Object Code	VARIABLE
Data type	INTEGER8
Savable	yes, category: application
Access	read / write
PDO mapping	RX-PDO
Allowed values	
Preset value	00 <sub>h</sub>
Firmware version	FIR-v1426
Change history	Firmware version FIR-v1626: "Savable" entry changed from "no" to "yes, category: application".

## Description

Mode	Description
-2	Auto setup
-1	Clock-direction mode
0	No mode change/no mode assigned
1	Profile Position Mode
2	Velocity Mode
3	Profile Velocity Mode
4	Profile Torque Mode
5	Reserved
6	Homing Mode
7	Interpolated Position Mode
8	Cyclic Synchronous Position Mode
9	Cyclic Synchronous Velocity Mode
10	Cyclic Synchronous Torque Mode

## 6061h Modes Of Operation Display

### Function

Indicates the current operating mode. See also [6060h Modes Of Operation](#).

### Object description

Index	6061 <sub>h</sub>
Object name	Modes Of Operation Display
Object Code	VARIABLE
Data type	INTEGER8
Savable	no
Access	read only

PDO mapping	TX-PDO
Allowed values	
Preset value	00 <sub>h</sub>
Firmware version	FIR-v1426
Change history	

---

## 6062h Position Demand Value

### Function

Indicates the current demand position in user-defined units.

### Object description

Index	6062 <sub>h</sub>
Object name	Position Demand Value
Object Code	VARIABLE
Data type	INTEGER32
Savable	no
Access	read only
PDO mapping	TX-PDO
Allowed values	
Preset value	00000000 <sub>h</sub>
Firmware version	FIR-v1426
Change history	

---

## 6063h Position Actual Internal Value

### Function

Contains the current actual position in encoder increments. Unlike objects 6062<sub>h</sub> and 6064<sub>h</sub>, this value is not set to "0" following a Homing operation. The source is determined in 3203h Feedback Selection.



#### NOTICE

If the encoder resolution in object 608F<sub>h</sub> = zero, the numerical values of this object are invalid.

---

### Object description

Index	6063 <sub>h</sub>
Object name	Position Actual Internal Value
Object Code	VARIABLE
Data type	INTEGER32
Savable	no
Access	read only
PDO mapping	TX-PDO
Allowed values	
Preset value	00000000 <sub>h</sub>



Firmware version	FIR-v1426
Change history	

---

## 6064h Position Actual Value

### Function

Contains the current actual position in user-defined units. The source is determined in 3203h Feedback Selection.

### Object description

---

Index	6064 <sub>h</sub>
Object name	Position Actual Value
Object Code	VARIABLE
Data type	INTEGER32
Savable	no
Access	read only
PDO mapping	TX-PDO
Allowed values	
Preset value	00000000 <sub>h</sub>
Firmware version	FIR-v1426
Change history	

---

## 6065h Following Error Window

### Function

Defines the maximum allowed following error in user-defined units symmetrically to the demand position.

### Object description

---

Index	6065 <sub>h</sub>
Object name	Following Error Window
Object Code	VARIABLE
Data type	UNSIGNED32
Savable	yes, category: application
Access	read / write
PDO mapping	RX-PDO
Allowed values	
Preset value	00000100 <sub>h</sub>
Firmware version	FIR-v1426
Change history	Firmware version FIR-v1504: "Savable" entry changed from "no" to "yes, category: application".

---

## Description

If the actual position deviates so much from the demand position that the value of this object is exceeded, bit 13 in object [6041<sub>h</sub>](#) is set. The deviation must last longer than the time in object [6066<sub>h</sub>](#).

If the value of the "Following Error Window" is set to "FFFFFFF"<sub>h</sub>, following error monitoring is switched off.

A reaction to the following error can be set in object [3700<sub>h</sub>](#). If a reaction is defined, an error is also entered in object [1003<sub>h</sub>](#).

## 6066h Following Error Time Out

### Function

Time in milliseconds until a larger following error results in an error message.

### Object description

Index	6066 <sub>h</sub>
Object name	Following Error Time Out
Object Code	VARIABLE
Data type	UNSIGNED16
Savable	yes, category: application
Access	read / write
PDO mapping	RX-PDO
Allowed values	
Preset value	0064 <sub>h</sub>
Firmware version	FIR-v1426
Change history	Firmware version FIR-v1504: "Savable" entry changed from "no" to "yes, category: application".

## Description

If the actual position deviates so much from the demand position that the value of object [6065<sub>h</sub>](#) is exceeded, bit 13 in object [6041<sub>h</sub>](#) is set. The deviation must persist for longer than the time defined in this object.

A reaction to the following error can be set in object [3700<sub>h</sub>](#). If a reaction is defined, an error is also entered in object [1003<sub>h</sub>](#).

## 6067h Position Window

### Function

Specifies a range symmetrical to the target position within which that target is considered having been met in modes [Profile Position](#) and [Interpolated Position Mode](#).

### Object description

Index	6067 <sub>h</sub>
Object name	Position Window
Object Code	VARIABLE
Data type	UNSIGNED32
Savable	yes, category: application
Access	read / write

PDO mapping	RX-PDO
Allowed values	
Preset value	0000000A <sub>h</sub>
Firmware version	FIR-v1426
Change history	Firmware version FIR-v1504: "Savable" entry changed from "no" to "yes, category: application".

---

## Description

If the current position deviates from the target position by less than the value of this object, bit 10 in object [6041<sub>h</sub>](#) is set. The condition must be satisfied for longer than the time defined in object [6068<sub>h</sub>](#).

If the value is set to "FFFFFFF"<sub>h</sub>, monitoring is switched off.

## 6068h Position Window Time

### Function

The current position must be within the "Position Window" ([6067<sub>h</sub>](#)) for this time in milliseconds for the target position to be considered having been met in the Profile Position and Interpolated Position Mode modes.

### Object description

Index	6068 <sub>h</sub>
Object name	Position Window Time
Object Code	VARIABLE
Data type	UNSIGNED16
Savable	yes, category: application
Access	read / write
PDO mapping	RX-PDO
Allowed values	
Preset value	0064 <sub>h</sub>
Firmware version	FIR-v1426
Change history	Firmware version FIR-v1504: "Savable" entry changed from "no" to "yes, category: application".

---

## Description

If the current position deviates from the target position by less than the value of object [6067<sub>h</sub>](#), bit 10 in object [6041<sub>h</sub>](#) is set. The condition must be satisfied for longer than the time defined in object [6068<sub>h</sub>](#).

## 606Bh Velocity Demand Value

### Function

Speed specification in user-defined units for the velocity controller.

### Object description

Index	606B <sub>h</sub>
Object name	Velocity Demand Value

Object Code	VARIABLE
Data type	INTEGER32
Savable	no
Access	read only
PDO mapping	TX-PDO
Allowed values	
Preset value	00000000 <sub>h</sub>
Firmware version	FIR-v1426
Change history	

---

## Description

This object contains the output of the ramp generator, which simultaneously serves as the preset value for the velocity controller.

## 606Ch Velocity Actual Value

### Function

Current actual speed in user-defined units.

### Object description

---

Index	606C <sub>h</sub>
Object name	Velocity Actual Value
Object Code	VARIABLE
Data type	INTEGER32
Savable	no
Access	read only
PDO mapping	TX-PDO
Allowed values	
Preset value	00000000 <sub>h</sub>
Firmware version	FIR-v1426
Change history	

---

## 606Dh Velocity Window

### Function

Specifies a symmetrical range relative to the target speed within which the target is considered having been met in the Profile Velocity mode.

### Object description

---

Index	606D <sub>h</sub>
Object name	Velocity Window
Object Code	VARIABLE
Data type	UNSIGNED16
Savable	yes, category: application
Access	read / write

PDO mapping	RX-PDO
Allowed values	
Preset value	001E <sub>h</sub>
Firmware version	FIR-v1426
Change history	Firmware version FIR-v1614: "Savable" entry changed from "no" to "yes, category: application".

---

## Description

If the current speed deviates from the set speed by less than the value of this object, bit 10 in object 6041<sub>h</sub> is set. The condition must be satisfied for longer than the time defined in object 606E<sub>h</sub> (see also [statusword in Profile Velocity Mode](#)).

## 606Eh Velocity Window Time

### Function

The current speed must be within the "Velocity Window" (606D<sub>h</sub>) for this time (in milliseconds) for the target to be considered having been met.

### Object description

Index	606E <sub>h</sub>
Object name	Velocity Window Time
Object Code	VARIABLE
Data type	UNSIGNED16
Savable	yes, category: application
Access	read / write
PDO mapping	RX-PDO
Allowed values	
Preset value	0000 <sub>h</sub>
Firmware version	FIR-v1426
Change history	Firmware version FIR-v1614: "Savable" entry changed from "no" to "yes, category: application".

---

## Description

### Description

If the current speed deviates from the set speed by less than the value of object 606D<sub>h</sub>, bit 10 in object 6041<sub>h</sub> is set. The condition must be satisfied for longer than the time defined in object 606E (see also [statusword in Profile Velocity Mode](#)).

## 606Fh Velocity Threshold

### Function

Speed in [user-defined units](#) above which the actual speed in [Profile Velocity](#) mode is considered to be nonzero.

## Object description

---

Index	606F <sub>h</sub>
Object name	Velocity Threshold
Object Code	VARIABLE
Data type	UNSIGNED16
Savable	yes, category: application
Access	read / write
PDO mapping	RX-PDO
Allowed values	
Preset value	0000 <sub>h</sub>
Firmware version	FIR-v2013-B726332
Change history	

---

### Description

If the actual speed is greater than the value in 606F<sub>h</sub>(Velocity Threshold) for a time of 6070<sub>h</sub>(Velocity Threshold Time), bit 12 in 6041<sub>h</sub>(Statusword) has the value "0". The bit otherwise remains set to "1".

### 6070h Velocity Threshold Time

#### Function

Time in milliseconds above which an actual speed greater than the value in 606F<sub>h</sub> in Profile Velocity mode is considered to be nonzero.

## Object description

---

Index	6070 <sub>h</sub>
Object name	Velocity Threshold Time
Object Code	VARIABLE
Data type	UNSIGNED16
Savable	yes, category: application
Access	read / write
PDO mapping	RX-PDO
Allowed values	
Preset value	0000 <sub>h</sub>
Firmware version	FIR-v2013-B726332
Change history	

---

### Description

If the actual speed is greater than the value in 606F<sub>h</sub>(Velocity Threshold) for a time of 6070<sub>h</sub>(Velocity Threshold Time), bit 12 in 6041<sub>h</sub>(Statusword) has the value "0". The bit otherwise remains set to "1".

### 6071h Target Torque

#### Function

This object contains the target torque for the Profile Torque and Cyclic Synchronous Torque modes in tenths of a percent of the rated torque.

## Object description

Index	6071 <sub>h</sub>
Object name	Target Torque
Object Code	VARIABLE
Data type	INTEGER16
Savable	yes, category: application
Access	read / write
PDO mapping	RX-PDO
Allowed values	
Preset value	0000 <sub>h</sub>
Firmware version	FIR-v1426
Change history	Firmware version FIR-v1626: "Savable" entry changed from "no" to "yes, category: application".

## Description

This object is calculated as thousandths of the torque, e.g., the value "500" means "50%" of the rated torque; "1100" is equivalent to 110%. The rated torque corresponds to the rated current in object 203B<sub>h</sub>:01.

The minimum of 6073<sub>h</sub> and 6072<sub>h</sub> is used as limit for the torque in 6071<sub>h</sub>.

The target torque may not exceed the peak torque (proportional to the maximum motor current in 2031<sub>h</sub>).

## 6072h Max Torque

### Function

The object describes the maximum torque for the Profile Torque and Cyclic Synchronous Torque modes in tenths of a percent of the rated torque.

## Object description

Index	6072 <sub>h</sub>
Object name	Max Torque
Object Code	VARIABLE
Data type	UNSIGNED16
Savable	yes, category: application
Access	read / write
PDO mapping	RX-PDO
Allowed values	
Preset value	0064 <sub>h</sub>
Firmware version	FIR-v1426
Change history	

## Description

This object is calculated as thousandths of the torque, e.g., the value "500" means "50%" of the rated torque; "1100" is equivalent to 110%. The rated torque corresponds to the rated current in object 203B<sub>h</sub>:01.

The minimum of 6073<sub>h</sub> and 6072<sub>h</sub> is used as limit for the torque in 6071<sub>h</sub>.

The target torque may not exceed the peak torque (proportional to the maximum motor current in 2031<sub>h</sub>).

## 6073h Max Current

### Function

Contains the maximum current in tenths of a percent of the set rated current. Is limited by the maximum motor current (2031<sub>h</sub>). See also I2t Motor overload protection.

#### NOTICE



For stepper motors, only the rated current is specified, not a maximum current. Therefore, the value of 6073<sub>h</sub> should generally not exceed the value 1000 (100%).

### Object description

Index	6073 <sub>h</sub>
Object name	Max Current
Object Code	VARIABLE
Data type	UNSIGNED16
Savable	yes, category: drive
Access	read / write
PDO mapping	RX-PDO
Allowed values	
Preset value	03E8 <sub>h</sub>
Firmware version	FIR-v1825-B577172
Change history	

### Description

The maximum current is calculated in tenths of a percent of the rated current as follows:

$$(6073_{\text{h}} * 203\text{B}_{\text{h}}:01) / 1000$$

The maximum current determines:

- the maximum current for the I2t Motor overload protection
- the rated current in *open loop* mode.

## 6074h Torque Demand

### Function

Current torque set value requested by the ramp generator in tenths of a percent of the rated torque for the internal controller.

### Object description

Index	6074 <sub>h</sub>
Object name	Torque Demand
Object Code	VARIABLE
Data type	INTEGER16
Savable	no



Access	read only
PDO mapping	TX-PDO
Allowed values	
Preset value	0000 <sub>h</sub>
Firmware version	FIR-v1426
Change history	

---

## Description

This object is calculated as thousandths of the torque, e.g., the value "500" means "50%" of the rated torque; "1100" is equivalent to 110%. The rated torque corresponds to the rated current in object 203B<sub>h</sub>:01.

The minimum of 6073<sub>h</sub> and 6072<sub>h</sub> is used as limit for the torque in 6071<sub>h</sub>.

The target torque may not exceed the peak torque (proportional to the maximum motor current in 2031<sub>h</sub>).

## 6075h Motor Rated Current

### Function

Contains the rated current entered in 203B<sub>h</sub>:01<sub>h</sub> in mA.

## 6077h Torque Actual Value

### Function

This object indicates the current torque value in tenths of a percent of the rated torque for the internal controller.

### Object description

---

Index	6077 <sub>h</sub>
Object name	Torque Actual Value
Object Code	VARIABLE
Data type	INTEGER16
Savable	no
Access	read only
PDO mapping	TX-PDO
Allowed values	
Preset value	0000 <sub>h</sub>
Firmware version	FIR-v1540
Change history	

---

## Description

This object is calculated as thousandths of the torque, e.g., the value "500" means "50%" of the rated torque; "1100" is equivalent to 110%. The rated torque corresponds to the rated current in object 203B<sub>h</sub>:01.

The minimum of 6073<sub>h</sub> and 6072<sub>h</sub> is used as limit for the torque in 6071<sub>h</sub>.

The target torque may not exceed the peak torque (proportional to the maximum motor current in 2031<sub>h</sub>).

## 607Ah Target Position

### Function

This object specifies the target position in user-defined units for the Profile Position and Cyclic Synchronous Position modes.

### Object description

Index	607A <sub>h</sub>
Object name	Target Position
Object Code	VARIABLE
Data type	INTEGER32
Savable	yes, category: application
Access	read / write
PDO mapping	RX-PDO
Allowed values	
Preset value	00000FA0 <sub>h</sub>
Firmware version	FIR-v1426
Change history	Firmware version FIR-v1626: "Savable" entry changed from "no" to "yes, category: application".

## 607Bh Position Range Limit

### Function

Contains the minimum and maximum position in user-defined units.

### Object description

Index	607B <sub>h</sub>
Object name	Position Range Limit
Object Code	ARRAY
Data type	INTEGER32
Savable	yes, category: application
Firmware version	FIR-v1426
Change history	

### Value description

Subindex	00 <sub>h</sub>
Name	Number Of Entries
Data type	UNSIGNED8
Access	read only
PDO mapping	no
Allowed values	
Preset value	02 <sub>h</sub>

Subindex	01 <sub>h</sub>
Name	Min Position Range Limit
Data type	INTEGER32
Access	read / write
PDO mapping	RX-PDO
Allowed values	
Preset value	00000000 <sub>h</sub>

Subindex	02 <sub>h</sub>
Name	Max Position Range Limit
Data type	INTEGER32
Access	read / write
PDO mapping	RX-PDO
Allowed values	
Preset value	00000000 <sub>h</sub>

## Description

If this range is exceeded or not reached, an overflow occurs. To prevent this overflow, limit values for the target position can be set in object 607D<sub>h</sub> ("Software Position Limit").

## 607Ch Home Offset

### Function

Specifies the difference between the zero position of the controller and the reference point of the machine in user-defined units.

### Object description

Index	607C <sub>h</sub>
Object name	Home Offset
Object Code	VARIABLE
Data type	INTEGER32
Savable	yes, category: application
Access	read / write
PDO mapping	RX-PDO
Allowed values	
Preset value	00000000 <sub>h</sub>
Firmware version	FIR-v1426
Change history	

## 607Dh Software Position Limit

### Function

Defines the limit positions relative to the reference point of the application in user-defined units.

## Object description

Index	607D <sub>h</sub>
Object name	Software Position Limit
Object Code	ARRAY
Data type	INTEGER32
Savable	yes, category: application
Firmware version	FIR-v1426
Change history	

## Value description

Subindex	00 <sub>h</sub>
Name	Number Of Entries
Data type	UNSIGNED8
Access	read only
PDO mapping	no
Allowed values	
Preset value	02 <sub>h</sub>

Subindex	01 <sub>h</sub>
Name	Min Position Limit
Data type	INTEGER32
Access	read / write
PDO mapping	RX-PDO
Allowed values	
Preset value	00000000 <sub>h</sub>

Subindex	02 <sub>h</sub>
Name	Max Position Limit
Data type	INTEGER32
Access	read / write
PDO mapping	RX-PDO
Allowed values	
Preset value	00000000 <sub>h</sub>

## Description

The absolute target position must lie within the limits set here. The Home Offset (607C<sub>h</sub>) is not taken into account.

## 607Eh Polarity

### Function

With this object, the direction of rotation can be reversed.

## Object description

Index	607E <sub>h</sub>
Object name	Polarity
Object Code	VARIABLE
Data type	UNSIGNED8
Savable	yes, category: application
Access	read / write
PDO mapping	RX-PDO
Allowed values	
Preset value	00 <sub>h</sub>
Firmware version	FIR-v1426
Change history	Firmware version FIR-v1738-B501312: "PDO mapping" table entry for subindex 00 changed from "no" to "RX-PDO".

## Description

The following generally applies for direction reversal: If a bit is set to the value "1", reversal is activated. If the value is "0", the direction of rotation is as described in the respective mode.

7	6	5	4	3	2	1	0
POS	VEL						

### VEL (Velocity)

Direction of rotation reversal in the following modes:

- [Profile Velocity Mode](#)
- [Cyclic Synchronous Velocity Mode](#)

### POS (Position)

Direction of rotation reversal in the following modes:

- [Profile Position Mode](#)
- [Cyclic Synchronous Position Mode](#)



#### TIP

You can force an inversion of the rotary field that affects all operating modes. See object [3212<sub>h</sub>:02<sub>h</sub>](#).

## 607Fh Max Profile Velocity

### Function

Specifies the maximum speed in user-defined units for which the Mod i [Profile Position](#) , [Interpolated Position Mode](#) (only if [closed loop](#) is activated) and [Profile Velocity](#).

### Object description

Index	607F <sub>h</sub>
Object name	Max Profile Velocity

Object Code	VARIABLE
Data type	UNSIGNED32
Savable	yes, category: application
Access	read / write
PDO mapping	RX-PDO
Allowed values	
Preset value	00007530 <sub>h</sub>
Firmware version	FIR-v1540
Change history	<p>Firmware version FIR-v1738-B501312: "Object Name" entry changed from "Max profile velocity" to "Max Profile Velocity".</p> <p>Firmware version FIR-v1738-B501312: "Data type" entry changed from "INTEGER16" to "UNSIGNED32".</p> <p>Firmware version FIR-v1738-B501312: "Savable" entry changed from "no" to "yes, category: application".</p> <p>Firmware version FIR-v1738-B501312: "Access" table entry for subindex 00 changed from "read only" to "read/write".</p> <p>Firmware version FIR-v1738-B501312: "PDO mapping" table entry for subindex 00 changed from "TX-PDO" to "RX-PDO".</p>

---

## 6080h Max Motor Speed

### Function

Contains the maximum permissible speed of the motor in user-defined units.

### Object description

Index	6080 <sub>h</sub>
Object name	Max Motor Speed
Object Code	VARIABLE
Data type	UNSIGNED32
Savable	yes, category: drive
Access	read / write
PDO mapping	RX-PDO
Allowed values	
Preset value	00007530 <sub>h</sub>
Firmware version	FIR-v1426
Change history	<p>Firmware version FIR-v1614: "Savable" entry changed from "yes, category: application" to "yes, category: tuning".</p> <p>Firmware version FIR-v1738-B501312: "Object Name" entry changed from "Maximum Speed" to "Max Motor Speed".</p> <p>Firmware version FIR-v1738-B501312: "PDO mapping" table entry for subindex 00 changed from "no" to "RX-PDO".</p> <p>Firmware version FIR-v1748-B538662: "Savable" entry changed from "yes, category: tuning" to "yes, category: movement".</p> <p>Firmware version FIR-v1825-B577172: "Savable" entry changed from "yes, category: movement" to "yes, category: tuning".</p>

Firmware version FIR-v1825-B577172: "Savable" entry changed from "yes, category: tuning" to "yes, category: movement".

---

## 6081h Profile Velocity

### Function

Specifies the maximum travel speed in user-defined units.

### Object description

Index	6081 <sub>h</sub>
Object name	Profile Velocity
Object Code	VARIABLE
Data type	UNSIGNED32
Savable	yes, category: application
Access	read / write
PDO mapping	RX-PDO
Allowed values	
Preset value	000001F4 <sub>h</sub>
Firmware version	FIR-v1426
Change history	

## 6082h End Velocity

### Function

Specifies the speed at the end of the traveled ramp in user-defined units.

### Object description

Index	6082 <sub>h</sub>
Object name	End Velocity
Object Code	VARIABLE
Data type	UNSIGNED32
Savable	yes, category: application
Access	read / write
PDO mapping	RX-PDO
Allowed values	
Preset value	00000000 <sub>h</sub>
Firmware version	FIR-v1426
Change history	

## 6083h Profile Acceleration

### Function

Specifies the maximum acceleration in user-defined units.

## Object description

Index	6083 <sub>h</sub>
Object name	Profile Acceleration
Object Code	VARIABLE
Data type	UNSIGNED32
Savable	yes, category: application
Access	read / write
PDO mapping	RX-PDO
Allowed values	
Preset value	000001F4 <sub>h</sub>
Firmware version	FIR-v1426
Change history	

## 6084h Profile Deceleration

### Function

Specifies the maximum deceleration (deceleration ramp) in user-defined units. Is limited by 60C6<sub>h</sub>.

### Object description

Index	6084 <sub>h</sub>
Object name	Profile Deceleration
Object Code	VARIABLE
Data type	UNSIGNED32
Savable	yes, category: application
Access	read / write
PDO mapping	RX-PDO
Allowed values	
Preset value	000001F4 <sub>h</sub>
Firmware version	FIR-v1426
Change history	

## 6085h Quick Stop Deceleration

### Function

Specifies the maximum Quick Stop Deceleration in user-defined units. Depending on the operating mode, is limited by 60C6<sub>h</sub> (Max Deceleration) and, if applicable, 60A4<sub>h</sub> (Profile Jerk).

### Object description

Index	6085 <sub>h</sub>
Object name	Quick Stop Deceleration
Object Code	VARIABLE
Data type	UNSIGNED32
Savable	yes, category: application



Access	read / write
PDO mapping	RX-PDO
Allowed values	
Preset value	00001388 <sub>h</sub>
Firmware version	FIR-v1426
Change history	

---

## 6086h Motion Profile Type

### Function

Specifies the ramp type for the Profile Position and Profile Velocity modes.

### Object description

Index	6086 <sub>h</sub>
Object name	Motion Profile Type
Object Code	VARIABLE
Data type	INTEGER16
Savable	yes, category: application
Access	read / write
PDO mapping	RX-PDO
Allowed values	
Preset value	0000 <sub>h</sub>
Firmware version	FIR-v1426
Change history	

---

### Description

Value = "0": = Trapezoidal ramp

Value = "3": Ramp with limited jerk

## 6087h Torque Slope

### Function

This object contains the slope of the torque in Torque mode.

### Object description

Index	6087 <sub>h</sub>
Object name	Torque Slope
Object Code	VARIABLE
Data type	UNSIGNED32
Savable	yes, category: application
Access	read / write
PDO mapping	RX-PDO
Allowed values	
Preset value	00000064 <sub>h</sub>

Firmware version	FIR-v1426
Change history	

---

## Description

This object is calculated as thousandths of the torque, e.g., the value "500" means "50%" of the rated torque; "1100" is equivalent to 110%. The rated torque corresponds to the rated current in object 203B<sub>h</sub>:01.

The minimum of 6073<sub>h</sub> and 6072<sub>h</sub> is used as limit for the torque in 6071<sub>h</sub>.

The target torque may not exceed the peak torque (proportional to the maximum motor current in 2031<sub>h</sub>).

## 608F<sub>h</sub> Position Encoder Resolution

### Function

Contains the physical resolution (see objects 60E6<sub>h</sub>/60EB<sub>h</sub>) of the encoder/sensor that is used for position control (see 3203<sub>h</sub> Feedback Selection).

### Object description

Index	608F <sub>h</sub>
Object name	Position Encoder Resolution
Object Code	ARRAY
Data type	INTEGER32
Savable	yes, category: tuning
Firmware version	FIR-v1426
Change history	<p>Firmware version FIR-v1738-B501312: "Savable" entry changed from "yes, category: application" to "yes, category: tuning".</p> <p>Firmware version FIR-v1738-B501312: "PDO mapping" table entry for subindex 01 changed from "no" to "RX-PDO".</p> <p>Firmware version FIR-v1738-B501312: "PDO mapping" table entry for subindex 02 changed from "no" to "RX-PDO".</p> <p>Firmware version FIR-v1748-B538662: "Data type" entry changed from "UNSIGNED32" to "INTEGER32".</p>

---

### Value description

Subindex	00 <sub>h</sub>
Name	Number Of Entries
Data type	UNSIGNED8
Access	read only
PDO mapping	no
Allowed values	
Preset value	02 <sub>h</sub>

---

Subindex	01 <sub>h</sub>
Name	Encoder Increments
Data type	INTEGER32

Access	read / write
PDO mapping	RX-PDO
Allowed values	
Preset value	00000000 <sub>h</sub>

---

Subindex	02 <sub>h</sub>
Name	Motor Revolutions
Data type	INTEGER32
Access	read / write
PDO mapping	RX-PDO
Allowed values	
Preset value	00000001 <sub>h</sub>

## Description

Position Encoder Resolution = Encoder Increments (608F<sub>h</sub>:01<sub>h</sub>) / Motor Revolutions (608F<sub>h</sub>:02<sub>h</sub>)

## 6090h Velocity Encoder Resolution

### Function

Contains the physical resolution (see objects 60E6<sub>h</sub>/ 60EB<sub>h</sub>) of the encoder/sensor that is used for speed control (see 3203h Feedback Selection).

### Object description

---

Index	6090 <sub>h</sub>
Object name	Velocity Encoder Resolution
Object Code	ARRAY
Data type	INTEGER32
Savable	yes, category: tuning
Access	read only
PDO mapping	no
Allowed values	
Preset value	
Firmware version	FIR-v1738-B501312
Change history	<p>Firmware version FIR-v1748-B538662: "Data type" entry changed from "UNSIGNED32" to "INTEGER32".</p> <p>Firmware version FIR-v1748-B538662: "Data type" entry changed from "UNSIGNED32" to "INTEGER32".</p> <p>Firmware version FIR-v1748-B538662: "Data type" entry changed from "UNSIGNED32" to "INTEGER32".</p> <p>Firmware version FIR-v1825-B577172: "Data type" entry changed from "INTEGER32" to "UNSIGNED32".</p> <p>Firmware version FIR-v1825-B577172: "Data type" entry changed from "INTEGER32" to "UNSIGNED32".</p> <p>Firmware version FIR-v1825-B577172: "Data type" entry changed from "INTEGER32" to "UNSIGNED32".</p>

Firmware version FIR-v1825-B577172: "Data type" entry changed from "UNSIGNED32" to "INTEGER32".

Firmware version FIR-v1825-B577172: "Data type" entry changed from "UNSIGNED32" to "INTEGER32".

Firmware version FIR-v1825-B577172: "Data type" entry changed from "UNSIGNED32" to "INTEGER32".

## Value description

Subindex	00 <sub>h</sub>
Name	Number Of Entries
Data type	UNSIGNED8
Access	read only
PDO mapping	no
Allowed values	
Preset value	02 <sub>h</sub>

Subindex	01 <sub>h</sub>
Name	Encoder Increments Per Second
Data type	INTEGER32
Access	read / write
PDO mapping	RX-PDO
Allowed values	
Preset value	00000000 <sub>h</sub>

Subindex	02 <sub>h</sub>
Name	Motor Revolutions Per Second
Data type	INTEGER32
Access	read / write
PDO mapping	RX-PDO
Allowed values	
Preset value	00000001 <sub>h</sub>

## Description

Velocity Encoder Resolution = Encoder Increments per second (6090<sub>h</sub>:01<sub>h</sub>) / Motor Revolutions per second (6090<sub>h</sub>:02<sub>h</sub>)

## 6091h Gear Ratio

### Function

Contains the gear ratio (number of motor revolutions per revolution of the output shaft) of the encoder/sensor that is used for position control (see [3203h Feedback Selection](#)).

## Object description

Index	6091 <sub>h</sub>
Object name	Gear Ratio
Object Code	ARRAY
Data type	UNSIGNED32
Savable	yes, category: application
Firmware version	FIR-v1426
Change history	<p>Firmware version FIR-v1738-B501312: "PDO mapping" table entry for subindex 01 changed from "no" to "RX-PDO".</p> <p>Firmware version FIR-v1738-B501312: "PDO mapping" table entry for subindex 02 changed from "no" to "RX-PDO".</p>

## Value description

Subindex	00 <sub>h</sub>
Name	Number Of Entries
Data type	UNSIGNED8
Access	read only
PDO mapping	no
Allowed values	
Preset value	02 <sub>h</sub>
Subindex	01 <sub>h</sub>
Name	Motor Revolutions
Data type	UNSIGNED32
Access	read / write
PDO mapping	RX-PDO
Allowed values	
Preset value	00000001 <sub>h</sub>
Subindex	02 <sub>h</sub>
Name	Shaft Revolutions
Data type	UNSIGNED32
Access	read / write
PDO mapping	RX-PDO
Allowed values	
Preset value	00000001 <sub>h</sub>

## Description

Gear Ratio = Motor Revolutions (6091<sub>h</sub>:01<sub>h</sub>) / Shaft Revolutions (6091<sub>h</sub>:02<sub>h</sub>)

## 6092h Feed Constant

### Function

Contains the feed constant (feed in user-defined units per revolution of the output shaft) of the encoder/sensor that is used for position control (see [3203h Feedback Selection](#)).

### Object description

Index	6092 <sub>h</sub>
Object name	Feed Constant
Object Code	ARRAY
Data type	UNSIGNED32
Savable	yes, category: application
Firmware version	FIR-v1426
Change history	

### Value description

Subindex	00 <sub>h</sub>
Name	Number Of Entries
Data type	UNSIGNED8
Access	read only
PDO mapping	no
Allowed values	
Preset value	02 <sub>h</sub>

Subindex	01 <sub>h</sub>
Name	Feed
Data type	UNSIGNED32
Access	read / write
PDO mapping	RX-PDO
Allowed values	
Preset value	00000001 <sub>h</sub>

Subindex	02 <sub>h</sub>
Name	Shaft Revolutions
Data type	UNSIGNED32
Access	read / write
PDO mapping	RX-PDO
Allowed values	
Preset value	00000001 <sub>h</sub>

### Description

Feed Constant = Feed (6092<sub>h</sub>:01<sub>h</sub>) / Shaft Revolutions (6092<sub>h</sub>:02<sub>h</sub>)

## 6096h Velocity Factor

### Function

This object contains the factor that is used for converting from user-defined speed units. See chapter [User-defined units](#).

### Object description

Index	6096 <sub>h</sub>
Object name	Velocity Factor
Object Code	ARRAY
Data type	UNSIGNED32
Savable	yes, category: application
Access	read only
PDO mapping	no
Allowed values	
Preset value	
Firmware version	FIR-v1738-B501312
Change history	

### Value description

Subindex	00 <sub>h</sub>
Name	Number Of Entries
Data type	UNSIGNED8
Access	read only
PDO mapping	no
Allowed values	
Preset value	02 <sub>h</sub>

Subindex	01 <sub>h</sub>
Name	Numerator
Data type	UNSIGNED32
Access	read / write
PDO mapping	RX-PDO
Allowed values	
Preset value	00000001 <sub>h</sub>

Subindex	02 <sub>h</sub>
Name	Divisor
Data type	UNSIGNED32
Access	read / write
PDO mapping	RX-PDO
Allowed values	
Preset value	00000001 <sub>h</sub>

## Description

The subindices have the following functions:

- 01<sub>h</sub>: Numerator of the factor
- 02<sub>h</sub>: Denominator of the factor

## 6097h Acceleration Factor

### Function

This object contains the factor that is used for converting from user-defined acceleration units. See chapter [User-defined units](#).

### Object description

Index	6097 <sub>h</sub>
Object name	Acceleration Factor
Object Code	ARRAY
Data type	UNSIGNED32
Savable	yes, category: application
Access	read only
PDO mapping	no
Allowed values	
Preset value	
Firmware version	FIR-v1738-B501312
Change history	

### Value description

Subindex	00 <sub>h</sub>
Name	Number Of Entries
Data type	UNSIGNED8
Access	read only
PDO mapping	no
Allowed values	
Preset value	02 <sub>h</sub>

Subindex	01 <sub>h</sub>
Name	Numerator
Data type	UNSIGNED32
Access	read / write
PDO mapping	RX-PDO
Allowed values	
Preset value	00000001 <sub>h</sub>

Subindex	02 <sub>h</sub>
Name	Divisor



Data type	UNSIGNED32
Access	read / write
PDO mapping	RX-PDO
Allowed values	
Preset value	00000001 <sub>h</sub>

---

## Description

The subindices have the following functions:

- 01<sub>h</sub>: Numerator of the factor
- 02<sub>h</sub>: Denominator of the factor

## 6098h Homing Method

### Function

This object defines the Homing method in Homing mode.

### Object description

---

Index	6098 <sub>h</sub>
Object name	Homing Method
Object Code	VARIABLE
Data type	INTEGER8
Savable	yes, category: application
Access	read / write
PDO mapping	RX-PDO
Allowed values	
Preset value	23 <sub>h</sub>
Firmware version	FIR-v1426
Change history	

---

## 6099h Homing Speed

### Function

Specifies the speeds for homing mode (6098<sub>h</sub>) in user-defined units.

### Object description

---

Index	6099 <sub>h</sub>
Object name	Homing Speed
Object Code	ARRAY
Data type	UNSIGNED32
Savable	yes, category: application
Firmware version	FIR-v1426
Change history	

---

## Value description

Subindex	00 <sub>h</sub>
Name	Number Of Entries
Data type	UNSIGNED8
Access	read only
PDO mapping	no
Allowed values	
Preset value	02 <sub>h</sub>

Subindex	01 <sub>h</sub>
Name	Speed During Search For Switch
Data type	UNSIGNED32
Access	read / write
PDO mapping	RX-PDO
Allowed values	
Preset value	00000032 <sub>h</sub>

Subindex	02 <sub>h</sub>
Name	Speed During Search For Zero
Data type	UNSIGNED32
Access	read / write
PDO mapping	RX-PDO
Allowed values	
Preset value	0000000A <sub>h</sub>

## Description

The speed for the search for the switch is specified in subindex 1.

The (lower) speed for the search for the reference position is specified in subindex 2.

### NOTICE



- The speed in subindex 2 is simultaneously the initial speed when starting the acceleration ramp. If this is set too high, the motor loses steps or fails to turn at all. If the setting is too high, the index marking will be overlooked, especially with high-resolution encoders. The minimum detectable width of the index pulse is 31.25 μs.
- The speed in subindex 1 must be greater than the speed in subindex 2.

## 609Ah Homing Acceleration

### Function

Specifies the acceleration ramp for homing mode in user-defined units.

## Object description

---

Index	609A <sub>h</sub>
Object name	Homing Acceleration
Object Code	VARIABLE
Data type	UNSIGNED32
Savable	yes, category: application
Access	read / write
PDO mapping	RX-PDO
Allowed values	
Preset value	000001F4 <sub>h</sub>
Firmware version	FIR-v1426
Change history	

---

## Description

The ramp is only used when starting up. When the switch is reached, the motor immediately switches to the lower speed; when the end position is reached, it immediately stops.

## 60A2h Jerk Factor

### Function

This object contains the factor that is used for converting from user-defined jerk units. See chapter [User-defined units](#).

## Object description

---

Index	60A2 <sub>h</sub>
Object name	Jerk Factor
Object Code	ARRAY
Data type	UNSIGNED32
Savable	yes, category: application
Access	read only
PDO mapping	no
Allowed values	
Preset value	
Firmware version	FIR-v1738-B501312
Change history	

---

## Value description

---

Subindex	00 <sub>h</sub>
Name	Number Of Entries
Data type	UNSIGNED8
Access	read only
PDO mapping	no
Allowed values	

Preset value	02 <sub>h</sub>
Subindex	01 <sub>h</sub>
Name	Numerator
Data type	UNSIGNED32
Access	read / write
PDO mapping	RX-PDO
Allowed values	
Preset value	00000001 <sub>h</sub>
Subindex	02 <sub>h</sub>
Name	Divisor
Data type	UNSIGNED32
Access	read / write
PDO mapping	RX-PDO
Allowed values	
Preset value	00000001 <sub>h</sub>

## Description

The subindices have the following functions:

- 01<sub>h</sub>: Numerator of the factor
- 02<sub>h</sub>: Denominator of the factor

## 60A4h Profile Jerk

### Function

In the case of a ramp with limited jerk, the size of the jerk can be entered in this object. An entry with the value "0" means that the jerk is not limited.

### Object description

Index	60A4 <sub>h</sub>
Object name	Profile Jerk
Object Code	ARRAY
Data type	UNSIGNED32
Savable	yes, category: application
Firmware version	FIR-v1426
Change history	<p>Firmware version FIR-v1614: "Name" entry changed from "End Acceleration Jerk" to "Begin Deceleration Jerk".</p> <p>Firmware version FIR-v1614: "Name" entry changed from "Begin Deceleration Jerk" to "End Acceleration Jerk".</p>

## Value description

Subindex	00 <sub>h</sub>
Name	Number Of Entries
Data type	UNSIGNED8
Access	read only
PDO mapping	no
Allowed values	
Preset value	04 <sub>h</sub>

Subindex	01 <sub>h</sub>
Name	Begin Acceleration Jerk
Data type	UNSIGNED32
Access	read / write
PDO mapping	no
Allowed values	
Preset value	000003E8 <sub>h</sub>

Subindex	02 <sub>h</sub>
Name	Begin Deceleration Jerk
Data type	UNSIGNED32
Access	read / write
PDO mapping	no
Allowed values	
Preset value	000003E8 <sub>h</sub>

Subindex	03 <sub>h</sub>
Name	End Acceleration Jerk
Data type	UNSIGNED32
Access	read / write
PDO mapping	no
Allowed values	
Preset value	000003E8 <sub>h</sub>

Subindex	04 <sub>h</sub>
Name	End Deceleration Jerk
Data type	UNSIGNED32
Access	read / write
PDO mapping	no
Allowed values	
Preset value	000003E8 <sub>h</sub>

## Description

- Subindex 01<sub>h</sub> (*Begin Acceleration Jerk*): Initial jerk during acceleration
- Subindex 02<sub>h</sub> (*Begin Deceleration Jerk*): Initial jerk during braking
- Subindex 03<sub>h</sub> (*End Acceleration Jerk*): Final jerk during acceleration
- Subindex 04<sub>h</sub> (*End Deceleration Jerk*): Final jerk during braking

## 60A8h SI Unit Position

### Function

This object contains the position unit. See chapter [User-defined units](#).

### Object description

Index	60A8 <sub>h</sub>
Object name	SI Unit Position
Object Code	VARIABLE
Data type	UNSIGNED32
Savable	yes, category: application
Access	read / write
PDO mapping	no
Allowed values	
Preset value	FF410000 <sub>h</sub>
Firmware version	FIR-v1738-B501312
Change history	

## Description

Object 60A8<sub>h</sub> contains:

- Bits 16 to 23: The position unit (see chapter [Units](#))
- Bits 24 to 31: The exponent of a power of ten (see chapter [Units](#))

31	30	29	28	27	26	25	24	23	22	21	20	19	18	17	16
Factor								Unit							
15	14	13	12	11	10	9	8	7	6	5	4	3	2	1	0
reserved (00h)								reserved (00h)							

## 60A9h SI Unit Velocity

### Function

This object contains the speed unit. See chapter [User-defined units](#).

### Object description

Index	60A9 <sub>h</sub>
Object name	SI Unit Velocity
Object Code	VARIABLE
Data type	UNSIGNED32
Savable	yes, category: application

Access	read / write
PDO mapping	no
Allowed values	
Preset value	00B44700 <sub>h</sub>
Firmware version	FIR-v1738-B501312
Change history	

---

## Description

Object 60A9<sub>h</sub> contains:

- Bits 8 to 15: The time unit (see chapter [Units](#))
- Bits 16 to 23: The position unit (see chapter [Units](#))
- Bits 24 to 31: The exponent of a power of ten (see chapter [Units](#))

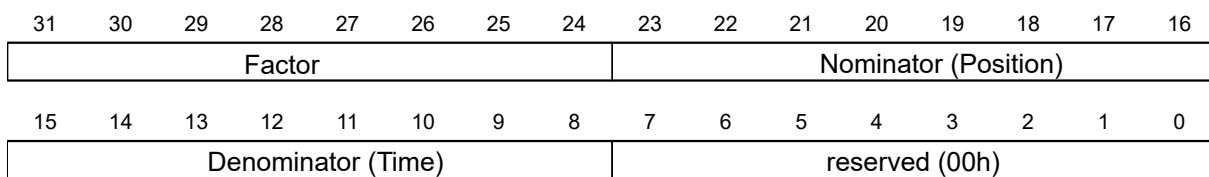

## 60B0h Position Offset

### Function

Offset for the position set value in user-defined units. Is taken into account in mode Cyclic Synchronous Position.

### Object description

---

Index	60B0 <sub>h</sub>
Object name	Position Offset
Object Code	VARIABLE
Data type	INTEGER32
Savable	yes, category: application
Access	read / write
PDO mapping	RX-PDO
Allowed values	
Preset value	00000000 <sub>h</sub>
Firmware version	FIR-v1738-B505321
Change history	

---

## 60B1h Velocity Offset

### Function

Offset for the speed set value in user-defined units. Is taken into account in the Cyclic Synchronous Position, Cyclic Synchronous Velocity and Clock-direction mode modes.

## Object description

---

Index	60B1 <sub>h</sub>
Object name	Velocity Offset
Object Code	VARIABLE
Data type	INTEGER32
Savable	yes, category: application
Access	read / write
PDO mapping	RX-PDO
Allowed values	
Preset value	00000000 <sub>h</sub>
Firmware version	FIR-v1738-B505321
Change history	

---

## 60B2h Torque Offset

### Function

Offset for the torque set value in tenths of a percent. Is taken into account in the Cyclic Synchronous Position, Cyclic Synchronous Velocity, Cyclic Synchronous Torque and Clock-direction mode modes.

### Object description

---

Index	60B2 <sub>h</sub>
Object name	Torque Offset
Object Code	VARIABLE
Data type	INTEGER16
Savable	yes, category: application
Access	read / write
PDO mapping	RX-PDO
Allowed values	
Preset value	0000 <sub>h</sub>
Firmware version	FIR-v1738-B505321
Change history	

---

## 60C1h Interpolation Data Record

### Function

This object contains the demand position in user-defined units for the interpolation algorithm for the interpolated position operating mode.

### Object description

---

Index	60C1 <sub>h</sub>
Object name	Interpolation Data Record
Object Code	ARRAY
Data type	INTEGER32
Savable	yes, category: application



Access	read only
PDO mapping	no
Allowed values	
Preset value	
Firmware version	FIR-v1512
Change history	Firmware version FIR-v1626: "Savable" entry changed from "no" to "yes, category: application".

---

## Value description

Subindex	00 <sub>h</sub>
Name	Number Of Entries
Data type	UNSIGNED8
Access	read only
PDO mapping	no
Allowed values	
Preset value	01 <sub>h</sub>

---

Subindex	01 <sub>h</sub>
Name	1st Set-point
Data type	INTEGER32
Access	read / write
PDO mapping	RX-PDO
Allowed values	
Preset value	00000000 <sub>h</sub>

---

## Description

The value is taken over at the next synchronization time.

## 60C2h Interpolation Time Period

### Function

This object contains the interpolation time.

### Object description

Index	60C2 <sub>h</sub>
Object name	Interpolation Time Period
Object Code	RECORD
Data type	INTERPOLATION_TIME_PERIOD
Savable	yes, category: application
Access	read only
PDO mapping	no
Allowed values	
Preset value	

Firmware version	FIR-v1426
Change history	

---

## Value description

Subindex	00 <sub>h</sub>
Name	Number Of Entries
Data type	UNSIGNED8
Access	read only
PDO mapping	no
Allowed values	
Preset value	02 <sub>h</sub>

---

Subindex	01 <sub>h</sub>
Name	Interpolation Time Period Value
Data type	UNSIGNED8
Access	read / write
PDO mapping	no
Allowed values	
Preset value	01 <sub>h</sub>

---

Subindex	02 <sub>h</sub>
Name	Interpolation Time Index
Data type	INTEGER8
Access	read / write
PDO mapping	no
Allowed values	
Preset value	FD <sub>h</sub>

---

## Description

The subindices have the following functions:

- 01<sub>h</sub>: Interpolation time.
- 02<sub>h</sub>: Power of ten of the interpolation time: must have the value -3 (corresponds to the time basis in milliseconds).

The following applies here: cycle time = value of 60C2<sub>h</sub>:01<sub>h</sub> \* 10<sup>value of 60C2:02</sup> seconds.

## 60C4h Interpolation Data Configuration

### Function

This object offers the maximum buffer size, specifies the configured buffer organization of the interpolated data and offers objects for defining the size of the record and for deleting the buffer.

It is also used to store the position of other data points.

## Object description

Index	60C4 <sub>h</sub>
Object name	Interpolation Data Configuration
Object Code	RECORD
Data type	INTERPOLATION_DATA_CONFIGURATION
Savable	yes, category: application
Access	read only
PDO mapping	no
Allowed values	
Preset value	
Firmware version	FIR-v1512
Change history	<p>Firmware version FIR-v1540: "Access" table entry for subindex 05 changed from "read/write" to "write only".</p> <p>Firmware version FIR-v1540: "Access" table entry for subindex 06 changed from "read/write" to "write only".</p> <p>Firmware version FIR-v1626: "Savable" entry changed from "no" to "yes, category: application".</p> <p>Firmware version FIR-v1650-B472161: "Access" table entry for subindex 01 changed from "read/write" to "read only".</p>

## Value description

Subindex	00 <sub>h</sub>
Name	Number Of Entries
Data type	UNSIGNED8
Access	read only
PDO mapping	no
Allowed values	
Preset value	06 <sub>h</sub>
Subindex	01 <sub>h</sub>
Name	MaximumBufferSize
Data type	UNSIGNED32
Access	read only
PDO mapping	no
Allowed values	
Preset value	00000001 <sub>h</sub>
Subindex	02 <sub>h</sub>
Name	ActualBufferSize
Data type	UNSIGNED32
Access	read / write
PDO mapping	no
Allowed values	

Preset value	00000001 <sub>h</sub>
Subindex	03 <sub>h</sub>
Name	BufferOrganization
Data type	UNSIGNED8
Access	read / write
PDO mapping	no
Allowed values	
Preset value	00 <sub>h</sub>
Subindex	04 <sub>h</sub>
Name	BufferPosition
Data type	UNSIGNED16
Access	read / write
PDO mapping	no
Allowed values	
Preset value	0001 <sub>h</sub>
Subindex	05 <sub>h</sub>
Name	SizeOfDataRecord
Data type	UNSIGNED8
Access	write only
PDO mapping	no
Allowed values	
Preset value	04 <sub>h</sub>
Subindex	06 <sub>h</sub>
Name	BufferClear
Data type	UNSIGNED8
Access	write only
PDO mapping	no
Allowed values	
Preset value	00 <sub>h</sub>

## Description

The value of subindex 01<sub>h</sub> contains the maximum possible number of interpolated records.

The value of subindex 02<sub>h</sub> contains the current number of interpolated records.

If subindex 03<sub>h</sub> is "00<sub>h</sub>", this means a FIFO buffer organization; if it is "01<sub>h</sub>", it specifies a ring buffer organization.

The value of subindex 04<sub>h</sub> is unitless and specifies the next free buffer entry point.

The value of subindex 05<sub>h</sub> is specified in units of "byte".

If the value "00<sub>h</sub>" is written in subindex 06<sub>h</sub>, it deletes the received data in the buffer, deactivates access and deletes all interpolated records.

If the value "01<sub>h</sub>" is written in subindex 06<sub>h</sub>, it activates access to the input buffer.

## 60C5h Max Acceleration

### Function

This object contains the maximum permissible acceleration for the Profile Position and Profile Velocity modes.

### Object description

Index	60C5 <sub>h</sub>
Object name	Max Acceleration
Object Code	VARIABLE
Data type	UNSIGNED32
Savable	yes, category: application
Access	read / write
PDO mapping	RX-PDO
Allowed values	
Preset value	00001388 <sub>h</sub>
Firmware version	FIR-v1426
Change history	

## 60C6h Max Deceleration

### Function

This object contains the maximum permissible deceleration (deceleration ramp) for the Profile Position, Profile Velocity and Interpolated Position Mode operating modes.

### Object description

Index	60C6 <sub>h</sub>
Object name	Max Deceleration
Object Code	VARIABLE
Data type	UNSIGNED32
Savable	yes, category: application
Access	read / write
PDO mapping	RX-PDO
Allowed values	
Preset value	00001388 <sub>h</sub>
Firmware version	FIR-v1426
Change history	

## 60E4h Additional Position Actual Value

### Function

Contains the current actual position of all existing feedbacks in user-defined units.

## Object description

Index	60E4 <sub>h</sub>
Object name	Additional Position Actual Value
Object Code	ARRAY
Data type	INTEGER32
Savable	no
Access	read only
PDO mapping	TX-PDO
Allowed values	
Preset value	
Firmware version	FIR-v1738-B501312
Change history	Firmware version FIR-v1748-B538662: "Data type" entry changed from "UNSIGNED32" to "INTEGER32".  Firmware version FIR-v1748-B538662: "Data type" entry changed from "UNSIGNED32" to "INTEGER32".

## Value description

Subindex	00 <sub>h</sub>
Name	Number Of Entries
Data type	UNSIGNED8
Access	read only
PDO mapping	TX-PDO
Allowed values	
Preset value	04 <sub>h</sub>

Subindex	01 <sub>h</sub> - 04 <sub>h</sub>
Name	Additional Position Actual Value #1 - #4
Data type	INTEGER32
Access	read only
PDO mapping	TX-PDO
Allowed values	
Preset value	00000000 <sub>h</sub>

## Description

The subindices have the following function:

- 00<sub>h</sub>: Value="1" to "n", where "n" is the number of existing feedbacks.
- n<sub>h</sub>:  
 Subindex n contains the current actual position of the corresponding feedback.  
 Subindex 01<sub>h</sub> always corresponds to the first (and always existing) *sensorless* feedback. The order of the remaining feedbacks corresponds to the table in chapter [Configuring the sensors](#).

## 60E5h Additional Velocity Actual Value

### Function

Contains the current actual speed of all existing feedbacks in user-defined units.

### Object description

Index	60E5 <sub>h</sub>
Object name	Additional Velocity Actual Value
Object Code	ARRAY
Data type	INTEGER32
Savable	no
Access	read only
PDO mapping	TX-PDO
Allowed values	
Preset value	
Firmware version	FIR-v1738-B501312
Change history	

### Value description

Subindex	00 <sub>h</sub>
Name	Number Of Entries
Data type	UNSIGNED8
Access	read only
PDO mapping	TX-PDO
Allowed values	
Preset value	04 <sub>h</sub>

Subindex	01 <sub>h</sub> - 04 <sub>h</sub>
Name	Additional Velocity Actual Value #1 - #4
Data type	INTEGER32
Access	read only
PDO mapping	TX-PDO
Allowed values	
Preset value	00000000 <sub>h</sub>

### Description

The subindices have the following function:

- 00<sub>h</sub>: Value="1" to "n", where "n" is the number of existing feedbacks.
- n<sub>h</sub>:  
 Subindex n contains the current actual speed of the corresponding feedback.  
 Subindex 01<sub>h</sub> always corresponds to the first (and always existing) *sensorless* feedback. The order of the remaining feedbacks corresponds to the table in chapter Configuring the sensors.

## 60E6h Additional Position Encoder Resolution - Encoder Increments

### Function

With this object and with [60EB<sub>h</sub>](#), the resolution of each existing feedback is calculated.

### Object description

Index	60E6 <sub>h</sub>
Object name	Additional Position Encoder Resolution - Encoder Increments
Object Code	ARRAY
Data type	INTEGER32
Savable	yes, category: tuning
Access	read only
PDO mapping	RX-PDO
Allowed values	
Preset value	
Firmware version	FIR-v1748-B538662
Change history	

### Value description

Subindex	00 <sub>h</sub>
Name	Number Of Entries
Data type	UNSIGNED8
Access	read only
PDO mapping	RX-PDO
Allowed values	
Preset value	04 <sub>h</sub>

Subindex	01 <sub>h</sub> - 04 <sub>h</sub>
Name	Additional Position Encoder Resolution - Encoder Increments Feedback Interface #1 - #4
Data type	INTEGER32
Access	read / write
PDO mapping	RX-PDO
Allowed values	
Preset value	00000000 <sub>h</sub>

### Description

The subindices have the following function:

- 00<sub>h</sub>: Value="1" to "n", where "n" is the number of existing feedbacks.
- n<sub>h</sub>:  
 Subindex n contains the number of increments of the corresponding feedback.  
 Subindex 01<sub>h</sub> always corresponds to the first (and always existing) *sensorless* feedback. The order of the remaining feedbacks corresponds to the table in chapter [Configuring the sensors](#).

The resolution of feedback "n" is calculated as follows:



Position Encoder Resolution = Encoder Increments (60E6<sub>h</sub>:01<sub>h</sub>) / Motor Revolutions (60EB<sub>h</sub>:02<sub>h</sub>)

#### NOTICE



The value "0" in a subindex means that the respective feedback is not connected and is not used. Thus, it is possible, for Example, to switch off the sensorless function to save computing time. This can be helpful if a *NanoJ* program needs the computing time.

If a value is not equal to "0" in a subindex, the controller checks the corresponding sensor when switching on. In case of an error (signal not present, invalid configuration/state), the error bit is set in the statusword and an error code stored in object 1003h.

## 60E8h Additional Gear Ratio - Motor Shaft Revolutions

### Function

In this object and in 60ED<sub>h</sub>, you can set the gear ratio of each existing feedback.

### Object description

Index	60E8 <sub>h</sub>
Object name	Additional Gear Ratio - Motor Shaft Revolutions
Object Code	ARRAY
Data type	UNSIGNED32
Savable	yes, category: application
Access	read only
PDO mapping	RX-PDO
Allowed values	
Preset value	
Firmware version	FIR-v1738-B501312
Change history	

### Value description

Subindex	00 <sub>h</sub>
Name	Number Of Entries
Data type	UNSIGNED8
Access	read only
PDO mapping	RX-PDO
Allowed values	
Preset value	04 <sub>h</sub>

Subindex	01 <sub>h</sub> - 04 <sub>h</sub>
Name	Additional Gear Ratio - Motor Shaft Revolutions Feedback Interface #1 - #4
Data type	UNSIGNED32
Access	read / write
PDO mapping	RX-PDO
Allowed values	

Preset value	00000001 <sub>h</sub>
--------------	-----------------------

## Description

The subindices have the following function:

- 00<sub>h</sub>: Value = "n", where "n" is the number of existing feedbacks.
- n<sub>h</sub>: Subindex "n" contains the number of motor revolutions for the corresponding feedback.  
 Subindex 01<sub>h</sub> always corresponds to the first (and always existing) *sensorless* feedback. The order of the remaining feedbacks corresponds to the table in chapter [Configuring the sensors](#).

The gear ratio of feedback "n" is calculated as follows:

Gear Ratio = Motor Shaft Revolutions (60E8<sub>h</sub>:n<sub>h</sub>) / Driving Shaft Revolutions (60ED<sub>h</sub>:n<sub>h</sub>)

## 60E9h Additional Feed Constant - Feed

### Function

In this object and in 60EE<sub>h</sub>, you can set a feed constant for each existing feedback.

### Object description

Index	60E9 <sub>h</sub>
Object name	Additional Feed Constant - Feed
Object Code	ARRAY
Data type	UNSIGNED32
Savable	yes, category: application
Access	read only
PDO mapping	RX-PDO
Allowed values	
Preset value	
Firmware version	FIR-v1738-B501312
Change history	

### Value description

Subindex	00 <sub>h</sub>
Name	Number Of Entries
Data type	UNSIGNED8
Access	read only
PDO mapping	RX-PDO
Allowed values	
Preset value	04 <sub>h</sub>
Subindex	01 <sub>h</sub> - 04 <sub>h</sub>
Name	Additional Feed Constant - Feed Feedback Interface #1 - #4
Data type	UNSIGNED32
Access	read / write
PDO mapping	RX-PDO

Allowed values	
Preset value	00000001 <sub>h</sub>

---

## Description

The subindices have the following function:

- 00<sub>h</sub>: Value = "n", where "n" is the number of existing feedbacks.
- n<sub>h</sub>: Subindex "n" contains the feed in user-defined units for the corresponding feedback. Subindex 01<sub>h</sub> always corresponds to the first (and always existing) *sensorless* feedback. The order of the remaining feedbacks corresponds to the table in chapter Configuring the sensors.

The feed constant of feedback "n" is calculated as follows:

$$\text{Feed Constant} = \text{Feed (60E9}_{h:n_h}) / \text{Driving Shaft Revolutions (60EE}_{h:n_h})$$

## 60EBh Additional Position Encoder Resolution - Motor Revolutions

### Function

With this object and with 60E6<sub>h</sub>, the resolution of each existing feedback is calculated.

### Object description

---

Index	60EB <sub>h</sub>
Object name	Additional Position Encoder Resolution - Motor Revolutions
Object Code	ARRAY
Data type	UNSIGNED32
Savable	yes, category: tuning
Access	read only
PDO mapping	RX-PDO
Allowed values	
Preset value	
Firmware version	FIR-v1738-B501312
Change history	

---

### Value description

---

Subindex	00 <sub>h</sub>
Name	Number Of Entries
Data type	UNSIGNED8
Access	read only
PDO mapping	RX-PDO
Allowed values	
Preset value	04 <sub>h</sub>

---



---

Subindex	01 <sub>h</sub> - 04 <sub>h</sub>
Name	Additional Position Encoder Resolution - Motor Revolutions Feedback Interface #1 - #4
Data type	UNSIGNED32

---

Access	read / write
PDO mapping	RX-PDO
Allowed values	
Preset value	00000001 <sub>h</sub>

---

## Description

The subindices have the following function:

- 00<sub>h</sub>: Value="1" to "n", where "n" is the number of existing feedbacks.
- n<sub>h</sub>:  
 Subindex n contains the number of motor revolutions of the corresponding feedback.  
 Subindex 01<sub>h</sub> always corresponds to the first (and always existing) *sensorless* feedback. The order of the remaining feedbacks corresponds to the table in chapter [Configuring the sensors](#).

The resolution of feedback "n" is calculated as follows:

Position Encoder Resolution = Encoder Increments (60E6<sub>h</sub>:n<sub>h</sub>) / Motor Revolutions (60EB<sub>h</sub>:n<sub>h</sub>)

## 60EDh Additional Gear Ratio - Driving Shaft Revolutions

### Function

In this object and in [60E8<sub>h</sub>](#), you can set the gear ratio of each existing feedback.

### Object description

---

Index	60ED <sub>h</sub>
Object name	Additional Gear Ratio - Driving Shaft Revolutions
Object Code	ARRAY
Data type	UNSIGNED32
Savable	yes, category: application
Access	read only
PDO mapping	RX-PDO
Allowed values	
Preset value	
Firmware version	FIR-v1738-B501312
Change history	

---

### Value description

---

Subindex	00 <sub>h</sub>
Name	Number Of Entries
Data type	UNSIGNED8
Access	read only
PDO mapping	RX-PDO
Allowed values	
Preset value	04 <sub>h</sub>

---



---

Subindex	01 <sub>h</sub> - 04 <sub>h</sub>
----------	-----------------------------------

---

Name	Additional Gear Ratio - Driving Shaft Revolutions Feedback Interface #1 - #4
Data type	UNSIGNED32
Access	read / write
PDO mapping	RX-PDO
Allowed values	
Preset value	00000001 <sub>h</sub>

## Description

The subindices have the following function:

- 00<sub>h</sub>: Value = "n", where "n" is the number of existing feedbacks.
- n<sub>h</sub>: Subindex "n" contains the number of revolutions of the output shaft for the corresponding feedback. Subindex 01<sub>h</sub> always corresponds to the first (and always existing) *sensorless* feedback. The order of the remaining feedbacks corresponds to the table in chapter [Configuring the sensors](#).

The gear ratio of feedback "n" is calculated as follows:

Gear Ratio = Motor Shaft Revolutions (60E8<sub>h</sub>:n<sub>h</sub>) / Driving Shaft Revolutions (60ED<sub>h</sub>:n<sub>h</sub>)

## 60EEh Additional Feed Constant - Driving Shaft Revolutions

### Function

In this object and in 60E9<sub>h</sub>, you can set a feed constant for each existing feedback.

### Object description

Index	60EE <sub>h</sub>
Object name	Additional Feed Constant - Driving Shaft Revolutions
Object Code	ARRAY
Data type	UNSIGNED32
Savable	yes, category: application
Access	read only
PDO mapping	RX-PDO
Allowed values	
Preset value	
Firmware version	FIR-v1738-B501312
Change history	

### Value description

Subindex	00 <sub>h</sub>
Name	Number Of Entries
Data type	UNSIGNED8
Access	read only
PDO mapping	RX-PDO
Allowed values	
Preset value	04 <sub>h</sub>

Subindex	01 <sub>h</sub> - 04 <sub>h</sub>
Name	Additional Feed Constant - Driving Shaft Revolutions Feedback Interface #1 - #4
Data type	UNSIGNED32
Access	read / write
PDO mapping	RX-PDO
Allowed values	
Preset value	00000001 <sub>h</sub>

## Description

The subindices have the following function:

- 00<sub>h</sub>: Value = "n", where "n" is the number of existing feedbacks.
- n<sub>h</sub>: Subindex "n" contains the number of revolutions of the output shaft for the corresponding feedback. Subindex 01<sub>h</sub> always corresponds to the first (and always existing) *sensorless* feedback. The order of the remaining feedbacks corresponds to the table in chapter [Configuring the sensors](#).

The feed constant of feedback "n" is calculated as follows:

Feed Constant = Feed (60E9<sub>h</sub>:n<sub>h</sub>) / Driving Shaft Revolutions (60EE<sub>h</sub>:n<sub>h</sub>)

## 60F2h Positioning Option Code

### Function

The object describes the positioning behavior in [Profile Position](#) mode.

### Object description

Index	60F2 <sub>h</sub>
Object name	Positioning Option Code
Object Code	VARIABLE
Data type	UNSIGNED16
Savable	yes, category: application
Access	read / write
PDO mapping	RX-PDO
Allowed values	
Preset value	0001 <sub>h</sub>
Firmware version	FIR-v1446
Change history	Firmware version FIR-v1614: "Savable" entry changed from "no" to "yes, category: application".

## Description

Only the following bits are supported at the present time:

15	14	13	12	11	10	9	8	7	6	5	4	3	2	1	0
MS	RESERVED [3]			IP OPTION [4]				RADO [2]	RRO [2]	CIO [2]	REL. OPT. [2]				

### REL. OPT. (Relative Option)

These bits determine the behavior with relative rotating movement in "profile position" mode if bit 6 of controlword  $6040_h$  = "1" is set.

Bit 1	Bit 0	Definition
0	0	Position movements are executed relative to the previous (internal absolute) target position (each relative to 0 if there is no previous target position)
0	1	Position movements are executed relative to the preset value (or output) of the ramp generator.
1	0	Position movements are performed relative to the current position (object $6064_h$ ).
1	1	Reserved

### RRO (Request-Response Option)

These bits determine the behavior when passing controlword  $6040_h$  bit 4 ("new setpoint") – in this case, the controller releases the bit itself. This eliminates the need to externally reset the bit to "0" afterwards. After the bit is set to the value "0" by the controller, bit 12 ("setpoint acknowledgment") is also set to the value "0" in statusword  $6041_h$ .



#### NOTICE

These options cause the controller to modify object controlword  $6040_h$ .

Bit 5	Bit 4	Definition
0	0	The functionality is as described under <a href="#">Setting travel commands</a> .
0	1	The controller releases the "new setpoint" bit as soon as the current targeted movement has reached its target.
1	0	The controller releases the "new setpoint" bit as soon as this is possible for the controller.
1	1	Reserved

### RADO (Rotary Axis Direction Option)

These bits determine the direction of rotation in "profile position" mode.

Bit 7	Bit 6	Definition
0	0	Normal positioning similar to a linear axis: If one of the "Position Range Limits" – $607B_h:01_h$ and $02_h$ – is reached or exceeded, the preset is automatically transferred to the other end of the limit. Only with this bit combination is a movement greater than the modulo value possible.
0	1	Positioning only in negative direction: If the target position is greater than the current position, the axis moves to the target position via the "Min Position Range Limit" from object $607D_h:01_h$ .
1	0	Positioning only in positive direction: If the target position is less than the current position, the axis moves to the target position via the "Max Position Range Limit" from object $607D_h:01_h$ .

Bit 7	Bit 6	Definition
1	1	Positioning with the shortest distance to the target position. If the difference between the current position and the target position in a 360° system is less than 180°, the axis moves in the positive direction.

## 60F4h Following Error Actual Value

### Function

This object contains the current following error in user-defined units.

### Object description

Index	60F4 <sub>h</sub>
Object name	Following Error Actual Value
Object Code	VARIABLE
Data type	INTEGER32
Savable	no
Access	read only
PDO mapping	TX-PDO
Allowed values	
Preset value	00000000 <sub>h</sub>
Firmware version	FIR-v1426
Change history	

## 60F8h Max Slippage

### Function

Defines the maximum allowed slippage error in user-defined units symmetrically to the set speed in Profile Velocity mode.

### Object description

Index	60F8 <sub>h</sub>
Object name	Max Slippage
Object Code	VARIABLE
Data type	INTEGER32
Savable	yes, category: application
Access	read / write
PDO mapping	RX-PDO
Allowed values	
Preset value	00000190 <sub>h</sub>
Firmware version	FIR-v1738-B501312
Change history	



## Description

If the actual speed deviates so much from the set speed that the value (absolute value) of this object is exceeded, bit 13 in object `6041h` is set. The deviation must last longer than the time in object `203Fh`.

If the value of `60F8h` is set to "7FFFFFFF"<sub>h</sub>, slippage error monitoring is switched off.

A reaction to the slippage error can be set in object `3700h`. If a reaction is defined, an error is also entered in object `1003h`.

## 60FAh Control Effort

### Function

This object contains the correction speed (control variable) in user-defined units that is fed to the velocity controller by the position controller.

### Object description

Index	60FA <sub>h</sub>
Object name	Control Effort
Object Code	VARIABLE
Data type	INTEGER32
Savable	no
Access	read only
PDO mapping	TX-PDO
Allowed values	
Preset value	00000000 <sub>h</sub>
Firmware version	FIR-v1748-B531667
Change history	

### Description

The position controller calculates a correction speed (in user-defined units) from the difference between the current position and the demand position which is then passed on to the velocity controller. This correction value is dependent on the proportional component and integral component of the position controller. See also chapter [Closed-Loop](#).

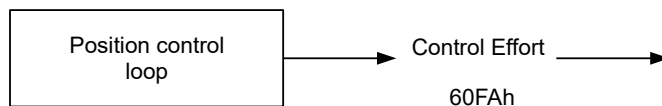

## 60FCh Position Demand Internal Value

### Function

Indicates the current preset value for the position controller in increments of the sensor selected for the position (see [Controller structure](#)).

## Object description

Index	60FC <sub>h</sub>
Object name	Position Demand Internal Value
Object Code	VARIABLE
Data type	INTEGER32
Savable	no
Access	read only
PDO mapping	TX-PDO
Allowed values	
Preset value	00000000 <sub>h</sub>
Firmware version	FIR-v1738-B501312
Change history	

## 60FDh Digital Inputs

### Function

With this object, the digital inputs of the motor can be read.

### Object description

Index	60FD <sub>h</sub>
Object name	Digital Inputs
Object Code	VARIABLE
Data type	UNSIGNED32
Savable	no
Access	read only
PDO mapping	TX-PDO
Allowed values	
Preset value	00000000 <sub>h</sub>
Firmware version	FIR-v1426
Change history	

### Description

31	30	29	28	27	26	25	24	23	22	21	20	19	18	17	16
							...	IN 8	IN 7	IN 6	IN 5	IN 4	IN 3	IN 2	IN 1
15	14	13	12	11	10	9	8	7	6	5	4	3	2	1	0
												IL	HS	PLS	NLS

#### NLS (Negative Limit Switch)

Negative limit switch

#### PLS (Positive Limit Switch)

Positive limit switch

#### HS (Home Switch)

Home switch

**IL (Interlock)***Interlock***IN n (Input n)**

Input n – the number of used bits is dependent on the given controller.

**60FEh Digital Outputs****Function**With this object, the digital outputs of the motor can be written.**Object description**

Index	60FE <sub>h</sub>
Object name	Digital Outputs
Object Code	ARRAY
Data type	UNSIGNED32
Savable	yes, category: application
Firmware version	FIR-v1426
Change history	Firmware version FIR-v1626: "Savable" entry changed from "no" to "yes, category: application". Firmware version FIR-v2213-B1028181: "Name" entry changed from "Digital Outputs #1" to "Physical Outputs".

**Value description**

Subindex	00 <sub>h</sub>
Name	Number Of Entries
Data type	UNSIGNED8
Access	read only
PDO mapping	no
Allowed values	
Preset value	01 <sub>h</sub>

Subindex	01 <sub>h</sub>
Name	Physical Outputs
Data type	UNSIGNED32
Access	read / write
PDO mapping	RX-PDO
Allowed values	
Preset value	00000001 <sub>h</sub>

**Description**To write the outputs, the entries in object 3250<sub>h</sub>, subindex 02<sub>h</sub> to 05<sub>h</sub>, must also be taken into account.

31	30	29	28	27	26	25	24	23	22	21	20	19	18	17	16
											...	OUT4	OUT3	OUT2	OUT1
15	14	13	12	11	10	9	8	7	6	5	4	3	2	1	0
															BRK

### BRK (Brake)

Bit for the brake output (if the controller supports this function):

Value "1" means that the brake is activated (no current can flow between the two pins of the brake connection; the brake is closed).

### OUT n (Output No n)

Bit for the respective digital output; the exact number of digital outputs is dependent on the controller.

## 60FFh Target Velocity

### Function

In this object, the target speed for the profile velocity and cyclic synchronous velocity modes is entered in user-defined units.

### Object description

Index	60FF <sub>h</sub>
Object name	Target Velocity
Object Code	VARIABLE
Data type	INTEGER32
Savable	yes, category: application
Access	read / write
PDO mapping	RX-PDO
Allowed values	
Preset value	00000000 <sub>h</sub>
Firmware version	FIR-v1426
Change history	Firmware version FIR-v1626: "Savable" entry changed from "no" to "yes, category: application".

## 6502h Supported Drive Modes

### Function

The object describes the supported operating modes in object 6060<sub>h</sub>.

### Object description

Index	6502 <sub>h</sub>
Object name	Supported Drive Modes
Object Code	VARIABLE
Data type	UNSIGNED32
Savable	no
Access	read only

PDO mapping	TX-PDO
Allowed values	
Preset value	000003EF <sub>h</sub>
Firmware version	FIR-v1426
Change history	

---

## Description

The set bit specifies whether the respective mode is supported. If the value of the bit is "0", the mode is not supported.

31	30	29	28	27	26	25	24	23	22	21	20	19	18	17	16
15	14	13	12	11	10	9	8	7	6	5	4	3	2	1	0
						CST	CSV	CSP	IP	HM		TQ	PV	VL	PP

### PP

Profile Position Mode

### VL

Velocity Mode

### PV

Profile Velocity Mode

### TQ

Torque Mode

### HM

Homing Mode

### IP

Interpolated Position Mode

### CSP

Cyclic Synchronous Position Mode

### CSV

Cyclic Synchronous Velocity Mode

### CST

Cyclic Synchronous Torque Mode

## 6503h Drive Catalogue Number

### Function

Contains the device name as character string.

### Object description

---

Index	6503 <sub>h</sub>
Object name	Drive Catalogue Number
Object Code	VARIABLE

Data type	VISIBLE_STRING
Savable	no
Access	read only
PDO mapping	no
Allowed values	
Preset value	0
Firmware version	FIR-v1426
Change history	

---

## 6505h Http Drive Catalogue Address

### Function

This object contains the manufacturer's web address as a character string.

### Object description

---

Index	6505 <sub>h</sub>
Object name	Http Drive Catalogue Address
Object Code	VARIABLE
Data type	VISIBLE_STRING
Savable	no
Access	read only
PDO mapping	no
Allowed values	
Preset value	0
Firmware version	FIR-v1426
Change history	

---

## 12 Copyrights

### 12.1 Introduction

Integrated in the Nanotec software are components from products from external software manufacturers. In this chapter, you will find the copyright information regarding the used external software sources.

### 12.2 AES

FIPS-197 compliant AES implementation

Based on XySSL: Copyright (C) 2006-2008 Christophe Devine

Copyright (C) 2009 Paul Bakker <polarssl\_maintainer at polarssl dot org>

All rights reserved.

Redistribution and use in source and binary forms, with or without modification, are permitted provided that the following conditions are met:

- Redistributions of source code must retain the above copyright notice, this list of conditions and the following disclaimer.
- Redistributions in binary form must reproduce the above copyright notice, this list of conditions and the following disclaimer in the documentation and/or other materials provided with the distribution; or, the application vendor's website must provide a copy of this notice.
- Neither the names of PolarSSL or XySSL nor the names of its contributors may be used to endorse or promote products derived from this software without specific prior written permission.

THIS SOFTWARE IS PROVIDED BY THE COPYRIGHT HOLDERS AND CONTRIBUTORS "AS IS" AND ANY EXPRESS OR IMPLIED WARRANTIES, INCLUDING, BUT NOT LIMITED TO, THE IMPLIED WARRANTIES OF MERCHANTABILITY AND FITNESS FOR A PARTICULAR PURPOSE ARE DISCLAIMED. IN NO EVENT SHALL THE COPYRIGHT OWNER OR CONTRIBUTORS BE LIABLE FOR ANY DIRECT, INDIRECT, INCIDENTAL, SPECIAL, EXEMPLARY, OR CONSEQUENTIAL DAMAGES (INCLUDING, BUT NOT LIMITED TO, PROCUREMENT OF SUBSTITUTE GOODS OR SERVICES; LOSS OF USE, DATA, OR PROFITS; OR BUSINESS INTERRUPTION) HOWEVER CAUSED AND ON ANY THEORY OF LIABILITY, WHETHER IN CONTRACT, STRICT LIABILITY, OR TORT (INCLUDING NEGLIGENCE OR OTHERWISE) ARISING IN ANY WAY OUT OF THE USE OF THIS SOFTWARE, EVEN IF ADVISED OF THE POSSIBILITY OF SUCH DAMAGE.

The AES block cipher was designed by Vincent Rijmen and Joan Daemen.

<http://csrc.nist.gov/encryption/aes/rijndael/Rijndael.pdf>

<http://csrc.nist.gov/publications/fips/fips197/fips-197.pdf>

### 12.3 MD5

MD5C.C - RSA Data Security, Inc., MD5 message-digest algorithm

Copyright (C) 1991-2, RSA Data Security, Inc. Created 1991. All rights reserved.

License to copy and use this software is granted provided that it is identified as the "RSA Data Security, Inc. MD5 Message-Digest Algorithm" in all material mentioning or referencing this software or this function.

License is also granted to make and use derivative works provided that such works are identified as "derived from the RSA Data Security, Inc. MD5 Message-Digest Algorithm" in all material mentioning or referencing the derived work.

RSA Data Security, Inc. makes no representations concerning either the merchantability of this software or the suitability of this software for any particular purpose. It is provided "as is" without express or implied warranty of any kind.

These notices must be retained in any copies of any part of this documentation and/or software.

## 12.4 uIP

Copyright (c) 2005, Swedish Institute of Computer Science

All rights reserved.

Redistribution and use in source and binary forms, with or without modification, are permitted provided that the following conditions are met:

1. Redistributions of source code must retain the above copyright notice, this list of conditions and the following disclaimer.
2. Redistributions in binary form must reproduce the above copyright notice, this list of conditions and the following disclaimer in the documentation and/or other materials provided with the distribution.
3. Neither the name of the Institute nor the names of its contributors may be used to endorse or promote products derived from this software without specific prior written permission.

THIS SOFTWARE IS PROVIDED BY THE INSTITUTE AND CONTRIBUTORS ``AS IS" AND ANY EXPRESS OR IMPLIED WARRANTIES, INCLUDING, BUT NOT LIMITED TO, THE IMPLIED WARRANTIES OF MERCHANTABILITY AND FITNESS FOR A PARTICULAR PURPOSE ARE DISCLAIMED. IN NO EVENT SHALL THE INSTITUTE OR CONTRIBUTORS BE LIABLE FOR ANY DIRECT, INDIRECT, INCIDENTAL, SPECIAL, EXEMPLARY, OR CONSEQUENTIAL DAMAGES (INCLUDING, BUT NOT LIMITED TO, PROCUREMENT OF SUBSTITUTE GOODS OR SERVICES; LOSS OF USE, DATA, OR PROFITS; OR BUSINESS INTERRUPTION) HOWEVER CAUSED AND ON ANY THEORY OF LIABILITY, WHETHER IN CONTRACT, STRICT LIABILITY, OR TORT (INCLUDING NEGLIGENCE OR OTHERWISE) ARISING IN ANY WAY OUT OF THE USE OF THIS SOFTWARE, EVEN IF ADVISED OF THE POSSIBILITY OF SUCH DAMAGE.

## 12.5 DHCP

Copyright (c) 2005, Swedish Institute of Computer Science

All rights reserved.

Redistribution and use in source and binary forms, with or without modification, are permitted provided that the following conditions are met:

1. Redistributions of source code must retain the above copyright notice, this list of conditions and the following disclaimer.
2. Redistributions in binary form must reproduce the above copyright notice, this list of conditions and the following disclaimer in the documentation and/or other materials provided with the distribution.
3. Neither the name of the Institute nor the names of its contributors may be used to endorse or promote products derived from this software without specific prior written permission.

THIS SOFTWARE IS PROVIDED BY THE INSTITUTE AND CONTRIBUTORS ``AS IS" AND ANY EXPRESS OR IMPLIED WARRANTIES, INCLUDING, BUT NOT LIMITED TO, THE IMPLIED WARRANTIES OF MERCHANTABILITY AND FITNESS FOR A PARTICULAR PURPOSE ARE DISCLAIMED. IN NO EVENT SHALL THE INSTITUTE OR CONTRIBUTORS BE LIABLE FOR ANY DIRECT, INDIRECT, INCIDENTAL, SPECIAL, EXEMPLARY, OR CONSEQUENTIAL DAMAGES (INCLUDING, BUT NOT LIMITED TO, PROCUREMENT OF SUBSTITUTE GOODS OR SERVICES; LOSS OF USE, DATA, OR PROFITS; OR BUSINESS INTERRUPTION) HOWEVER CAUSED AND ON ANY THEORY OF LIABILITY, WHETHER IN CONTRACT, STRICT LIABILITY, OR TORT (INCLUDING NEGLIGENCE OR OTHERWISE) ARISING IN ANY WAY OUT OF THE USE OF THIS SOFTWARE, EVEN IF ADVISED OF THE POSSIBILITY OF SUCH DAMAGE.

## 12.6 CMSIS DSP Software Library

Copyright (C) 2010 ARM Limited. All rights reserved.

## 12.7 FatFs

FatFs - FAT file system module include file R0.08 (C)ChaN, 2010



FatFs module is a generic FAT file system module for small embedded systems.

This is a free software that opened for education, research and commercial developments under license policy of following terms.

Copyright (C) 2010, ChaN, all right reserved.

The FatFs module is a free software and there is NO WARRANTY.

No restriction on use. You can use, modify and redistribute it for personal, non-profit or commercial product UNDER YOUR RESPONSIBILITY.

Redistributions of source code must retain the above copyright notice.

## 12.8 Protothreads

Protothread class and macros for lightweight, stackless threads in C++.

This was "ported" to C++ from Adam Dunkels' protothreads C library at: <http://www.sics.se/~adam/pt/>

Originally ported for use by Hamilton Jet ([www.hamiltonjet.co.nz](http://www.hamiltonjet.co.nz)) by Ben Hoyt, but stripped down for public release. See his blog entry about it for more information: <http://blog.micropledge.com/2008/07/protothreads/>

Original BSD-style license

Copyright (c) 2004-2005, Swedish Institute of Computer Science.

All rights reserved.

Redistribution and use in source and binary forms, with or without modification, are permitted provided that the following conditions are met:

1. Redistributions of source code must retain the above copyright notice, this list of conditions and the following disclaimer.
2. Redistributions in binary form must reproduce the above copyright notice, this list of conditions and the following disclaimer in the documentation and/or other materials provided with the distribution.
3. Neither the name of the Institute nor the names of its contributors may be used to endorse or promote products derived from this software without specific prior written permission.

This software is provided by the Institute and contributors "as is" and any express or implied warranties, including, but not limited to, the implied warranties of merchantability and fitness for a particular purpose are disclaimed. In no event shall the Institute or contributors be liable for any direct, indirect, incidental, special, exemplary, or consequential damages (including, but not limited to, procurement of substitute goods or services; loss of use, data, or profits; or business interruption) however caused and on any theory of liability, whether in contract, strict liability, or tort (including negligence or otherwise) arising in any way out of the use of this software, even if advised of the possibility of such damage.

## 12.9 lwIP

Copyright (c) 2001-2004 Swedish Institute of Computer Science.

All rights reserved.

Redistribution and use in source and binary forms, with or without modification, are permitted provided that the following conditions are met:

1. Redistributions of source code must retain the above copyright notice, this list of conditions and the following disclaimer.
2. Redistributions in binary form must reproduce the above copyright notice, this list of conditions and the following disclaimer in the documentation and/or other materials provided with the distribution.
3. The name of the author may not be used to endorse or promote products derived from this software without specific prior written permission.

THIS SOFTWARE IS PROVIDED BY THE AUTHOR ``AS IS" AND ANY EXPRESS OR IMPLIED WARRANTIES, INCLUDING, BUT NOT LIMITED TO, THE IMPLIED WARRANTIES OF MERCHANTABILITY AND FITNESS FOR A PARTICULAR PURPOSE ARE DISCLAIMED. IN NO

EVENT SHALL THE AUTHOR BE LIABLE FOR ANY DIRECT, INDIRECT, INCIDENTAL, SPECIAL, EXEMPLARY, OR CONSEQUENTIAL DAMAGES (INCLUDING, BUT NOT LIMITED TO, PROCUREMENT OF SUBSTITUTE GOODS OR SERVICES; LOSS OF USE, DATA, OR PROFITS; OR BUSINESS INTERRUPTION) HOWEVER CAUSED AND ON ANY THEORY OF LIABILITY, WHETHER IN CONTRACT, STRICT LIABILITY, OR TORT (INCLUDING NEGLIGENCE OR OTHERWISE) ARISING IN ANY WAY OUT OF THE USE OF THIS SOFTWARE, EVEN IF ADVISED OF THE POSSIBILITY OF SUCH DAMAGE.

This file is part of the lwIP TCP/IP stack.

Author: Adam Dunkels <adam@sics.se>

## 12.10 littlefs

```
/*  
 * The little filesystem  
 *  
 * Copyright (c) 2017, Arm Limited. All rights reserved.  
 * SPDX-License-Identifier: BSD-3-Clause  
 */
```

Copyright (c) 2017, Arm Limited. All rights reserved.

- Redistribution and use in source and binary forms, with or without modification, are permitted provided that the following conditions are met:
- Redistributions of source code must retain the above copyright notice, this list of conditions and the following disclaimer.
- Redistributions in binary form must reproduce the above copyright notice, this list of conditions and the following disclaimer in the documentation and/or other materials provided with the distribution.
- Neither the name of ARM nor the names of its contributors may be used to endorse or promote products derived from this software without specific prior written permission.

THIS SOFTWARE IS PROVIDED BY THE COPYRIGHT HOLDERS AND CONTRIBUTORS "AS IS" AND ANY EXPRESS OR IMPLIED WARRANTIES, INCLUDING, BUT NOT LIMITED TO, THE IMPLIED WARRANTIES OF MERCHANTABILITY AND FITNESS FOR A PARTICULAR PURPOSE ARE DISCLAIMED. IN NO EVENT SHALL THE COPYRIGHT HOLDER OR CONTRIBUTORS BE LIABLE FOR ANY DIRECT, INDIRECT, INCIDENTAL, SPECIAL, EXEMPLARY, OR CONSEQUENTIAL DAMAGES (INCLUDING, BUT NOT LIMITED TO, PROCUREMENT OF SUBSTITUTE GOODS OR SERVICES; LOSS OF USE, DATA, OR PROFITS; OR BUSINESS INTERRUPTION) HOWEVER CAUSED AND ON ANY THEORY OF LIABILITY, WHETHER IN CONTRACT, STRICT LIABILITY, OR TORT (INCLUDING NEGLIGENCE OR OTHERWISE) ARISING IN ANY WAY OUT OF THE USE OF THIS SOFTWARE, EVEN IF ADVISED OF THE POSSIBILITY OF SUCH DAMAGE.